

DRAWING LIST

NO	DRAWING TITLE	NUMBER	SKALA	NO	DRAWING TITLE	NUMBER	SKALA	NO	DRAWING TITLE	NUMBER	SKALA
1	EXISTING SITE	AR-001	1:200	52	GROUND FLOOR PLAN VILLA B	AR-052	1:100	103	ELEVATION VILLA C	AR-0103	1:100
2	MASTER PLAN GROUND FLOOR	AR-002	1:200	53	FIRST FLOOR PLAN VILLA B	AR-053	1:100	104	ELEVATION A-A VILLA C	AR-0104	1:100
3	MASTER PLAN FIRST FLOOR	AR-003	1:200	54	ROOF TOP PLAN VILLA B	AR-054	1:100	105	ELEVATION B-B VILLA C	AR-0105	1:100
4	MASTER PLAN ROOF TOP	AR-004	1:200	55	GROUND FLOOR DIMENSION PLAN VILLA B	AR-055	1:100	106	ELEVATION C-C VILLA C	AR-0106	1:100
5	SECTION SITE	AR-005	1:100	56	FIRST FLOOR DIMENSION PLAN VILLA B	AR-056	1:100	107	ELEVATION D-D VILLA C	AR-0107	1:100
6	ELEVATION SITE	AR-006	1:50	57	ROOF TOP DIMENSION PLAN VILLA B	AR-057	1:100	108	SECTION VILLA C	AR-0108	1:100
7	GROUND FLOOR PLAN VILLA A	AR-007	1:100	58	ELEVATION VILLA B	AR-058	1:100	109	SECTION A-A VILLA C	AR-0109	1:50
8	FIRST FLOOR PLAN VILLA A	AR-008	1:100	59	ELEVATION A-A VILLA B	AR-059	1:100	110	SECTION B-B VILLA C	AR-0110	1:50
9	ROOF TOP PLAN VILLA A	AR-009	1:100	60	ELEVATION B-B VILLA B	AR-060	1:100	111	SECTION C-C VILLA C	AR-0111	1:75
10	GROUND FLOOR DIMENSION PLAN VILLA A	AR-010	1:100	61	ELEVATION C-C VILLA B	AR-061	1:100	112	SECTION D-D VILLA C	AR-0112	1:75
11	FIRST FLOOR DIMENSION PLAN VILLA A	AR-011	1:100	62	ELEVATION D-D VILLA B	AR-062	1:100	113	MATERIAL SCHEDULE CEILING GROUND FLOOR PLAN VILLA C	AR-0113	1:100
12	ROOF TOP DIMENSION PLAN VILLA A	AR-012	1:100	63	SECTION VILLA B	AR-063	1:100	114	MATERIAL SCHEDULE CEILING FIRST FLOOR PLAN VILLA C	AR-0114	1:100
13	ELEVATION VILLA A	AR-013	1:100	64	SECTION A-A VILLA B	AR-064	1:50	115	MATERIAL SCHEDULE CEILING ROOF TOP PLAN VILLA C	AR-0115	1:100
14	ELEVATION A-A VILLA A	AR-014	1:100	65	SECTION B-B VILLA B	AR-065	1:50	116	MATERIAL SCHEDULE CEILING VILLA C	AR-0116	1:100
15	ELEVATION B-B VILLA A	AR-015	1:100	66	SECTION C-C VILLA B	AR-066	1:75	117	MATERIAL SCHEDULE FLOOR GROUND VILLA C	AR-0117	1:100
16	ELEVATION C-C VILLA A	AR-016	1:100	67	SECTION D-D VILLA B	AR-067	1:75	118	MATERIAL SCHEDULE FIRST FLOOR VILLA C	AR-0118	1:100
17	ELEVATION D-D VILLA A	AR-017	1:100	68	MATERIAL SCHEDULE CEILING GROUND FLOOR PLAN VILLA B	AR-068	1:100	119	MATERIAL SCHEDULE ROOF TOP VILLA C	AR-0119	1:100
18	SECTION VILLA A	AR-018	1:100	69	MATERIAL SCHEDULE CEILING FIRST FLOOR PLAN VILLA B	AR-069	1:100	120	MATERIAL SCHEDULE FLOOR VILLA C	AR-0120	1:100
19	SECTION A-A VILLA A	AR-019	1:50	70	MATERIAL SCHEDULE CEILING ROOF TOP PLAN VILLA B	AR-070	1:100	121	MATERIAL SCHEDULE WALL GROUND FLOOR VILLA C	AR-0121	1:100
20	SECTION B-B VILLA A	AR-020	1:50	71	MATERIAL SCHEDULE CEILING VILLA B	AR-071	1:100	122	MATERIAL SCHEDULE WALL FIRST FLOOR VILLA C	AR-0122	1:100
21	SECTION C-C VILLA A	AR-021	1:75	72	MATERIAL SCHEDULE FLOOR GROUND VILLA B	AR-072	1:100	123	MATERIAL SCHEDULE WALL VILLA C	AR-0123	1:100
22	SECTION D-D VILLA A	AR-022	1:75	73	MATERIAL SCHEDULE FIRST FLOOR VILLA B	AR-073	1:100	124	DOOR AND WINDOW PLAN VILLA C	AR-0124	1:100
23	MATERIAL SCHEDULE CEILING GROUND FLOOR PLAN VILLA A	AR-023	1:100	74	MATERIAL SCHEDULE ROOF TOP VILLA B	AR-074	1:100	125	DOOR AND WINDOW DETAIL 1	AR-0125	1:50
24	MATERIAL SCHEDULE CEILING FIRST FLOOR PLAN VILLA A	AR-024	1:100	75	MATERIAL SCHEDULE FLOOR VILLA B	AR-075	1:100	126	DOOR AND WINDOW DETAIL 2	AR-0126	1:50
25	MATERIAL SCHEDULE CEILING ROOF TOP PLAN VILLA A	AR-025	1:100	76	MATERIAL SCHEDULE WALL GROUND FLOOR VILLA B	AR-076	1:100	127	DOOR AND WINDOW DETAIL 3	AR-0127	1:50
26	MATERIAL SCHEDULE CEILING VILLA A	AR-026	1:100	77	MATERIAL SCHEDULE WALL FIRST FLOOR VILLA B	AR-077	1:100	128	POOL PLAN VILLA C	AR-0128	1:50
27	MATERIAL SCHEDULE FLOOR GROUND VILLA A	AR-027	1:100	78	MATERIAL SCHEDULE WALL VILLA B	AR-078	1:100	129	POOL SECTION AND DETAIL VILLA C	AR-0129	1:50
28	MATERIAL SCHEDULE FIRST FLOOR VILLA A	AR-028	1:100	79	DOOR AND WINDOW PLAN VILLA B	AR-079	1:100	130	STAIR PLAN, SECTION AND DETAIL VILLA C	AR-0130	1:50
29	MATERIAL SCHEDULE ROOF TOP VILLA A	AR-029	1:100	80	DOOR AND WINDOW DETAIL 1	AR-080	1:50	131	CABANA PLAN, SECTION AND DETAIL VILLA C	AR-0131	1:50
30	MATERIAL SCHEDULE FLOOR VILLA A	AR-030	1:100	81	DOOR AND WINDOW DETAIL 2	AR-081	1:50	132	GATE PLAN, SECTION AND DETAIL VILLA C	AR-0132	1:50
31	MATERIAL SCHEDULE WALL GROUND FLOOR VILLA A	AR-031	1:100	82	DOOR AND WINDOW DETAIL 3	AR-082	1:50	133	OUTDOOR SHOWER PLAN, SECTION AND DETAIL VILLA C	AR-0133	1:50
32	MATERIAL SCHEDULE WALL FIRST FLOOR VILLA A	AR-032	1:100	83	POOL PLAN VILLA B	AR-083	1:50	134	BATHROOM PLAN VILLA C	AR-0134	1:50
33	MATERIAL SCHEDULE WALL VILLA A	AR-033	1:100	84	POOL SECTION AND DETAIL VILLA B	AR-084	1:50	135	BATHROOM PLAN SECTION AND DETAIL VILLA C	AR-0135	1:50
34	DOOR AND WINDOW PLAN VILLA A	AR-034	1:100	85	STAIR PLAN, SECTION AND DETAIL VILLA B	AR-085	1:50	136	BUILT-IN FURNITURE BATHROOM VILLA C	AR-0136	1:75
35	DOOR AND WINDOW DETAIL 1	AR-035	1:50	86	CABANA PLAN, SECTION AND DETAIL VILLA B	AR-086	1:50	137	BUILT-IN FURNITURE BEDROOM VILLA C	AR-0137	1:75
36	DOOR AND WINDOW DETAIL 2	AR-036	1:50	87	GATE PLAN, SECTION AND DETAIL VILLA B	AR-087	1:50	138	BUILT-IN FURNITURE KITCHEN VILLA C	AR-0138	1:75
37	DOOR AND WINDOW DETAIL 3	AR-037	1:50	88	OUTDOOR SHOWER PLAN, SECTION AND DETAIL VILLA B	AR-088	1:50	139	BUILT-IN FURNITURE LIVING AREA VILLA C	AR-0139	1:75
38	POOL PLAN VILLA A	AR-038	1:50	89	BATHROOM PLAN VILLA B	AR-089	1:50	140	BLOW UP SECTION 1 VILLA C	AR-0140	1:100
39	POOL SECTION AND DETAIL VILLA A	AR-039	1:50	90	BATHROOM PLAN SECTION AND DETAIL VILLA B	AR-090	1:50	141	BLOW UP SECTION 2 VILLA C	AR-0141	1:100
40	STAIR PLAN, SECTION AND DETAIL VILLA A	AR-040	1:50	91	BUILT-IN FURNITURE BATHROOM VILLA B	AR-091	1:75				
41	CABANA PLAN, SECTION AND DETAIL VILLA A	AR-041	1:50	92	BUILT-IN FURNITURE BEDROOM VILLA B	AR-092	1:75				
42	GATE PLAN, SECTION AND DETAIL VILLA A	AR-042	1:50	93	BUILT-IN FURNITURE KITCHEN VILLA B	AR-093	1:75				
43	OUTDOOR SHOWER PLAN, SECTION AND DETAIL VILLA A	AR-043	1:50	94	BUILT-IN FURNITURE LIVING AREA VILLA B	AR-094	1:75				
44	BATHROOM PLAN VILLA A	AR-044	1:50	95	BLOW UP SECTION 1 VILLA B	AR-095	1:100				
45	BATHROOM PLAN SECTION AND DETAIL VILLA A	AR-045	1:50	96	BLOW UP SECTION 2 VILLA B	AR-096	1:100				
46	BUILT-IN FURNITURE BATHROOM VILLA A	AR-046	1:75	97	GROUND FLOOR PLAN VILLA C	AR-097	1:100				
47	BUILT-IN FURNITURE BEDROOM VILLA A	AR-047	1:75	98	FIRST FLOOR PLAN VILLA C	AR-098	1:100				
48	BUILT-IN FURNITURE KITCHEN VILLA A	AR-048	1:75	99	ROOF TOP PLAN VILLA C	AR-099	1:100				
49	BUILT-IN FURNITURE LIVING AREA VILLA A	AR-049	1:75	100	GROUND FLOOR DIMENSION PLAN VILLA C	AR-0100	1:100				
50	BLOW UP SECTION 1 VILLA A	AR-050	1:100	101	FIRST FLOOR DIMENSION PLAN VILLA C	AR-0101	1:100				
51	BLOW UP SECTION 2 VILLA A	AR-051	1:100	102	ROOF TOP DIMENSION PLAN VILLA C	AR-0102	1:100				





TOTAL LAND	= 657 M2
LAND FOR ROAD	= 101 M2
LAND TO BUILD	= 556 M2
SITE A	= 197 M2
SITE B	= 181 M2
SITE C	= 178 M2



TOTAL LAND	= 657 M2
LAND FOR ROAD	= 101 M2
LAND TO BUILD	= 556 M2
SITE A	= 197 M2
SITE B	= 181 M2
SITE C	= 178 M2



TOTAL LAND	= 657 M2
LAND FOR ROAD	= 101 M2
LAND TO BUILD	= 556 M2
SITE A	= 197 M2
SITE B	= 181 M2
SITE C	= 178 M2

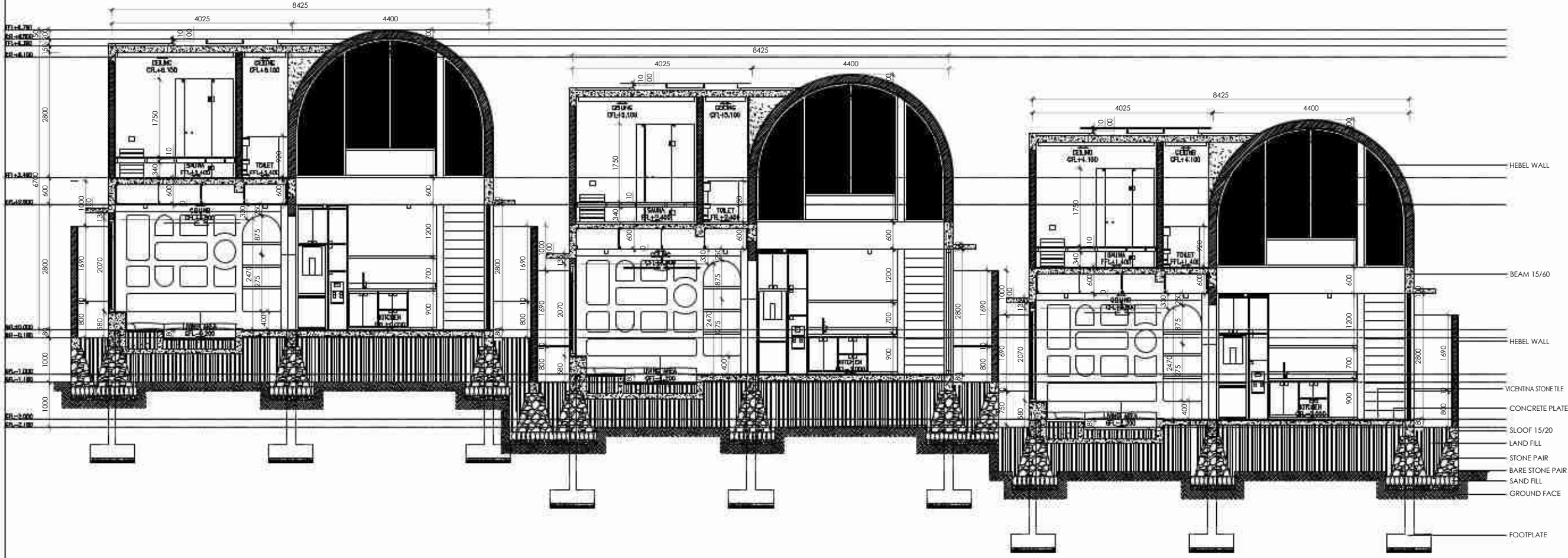

SECTION SITE
Scale 1 : 100

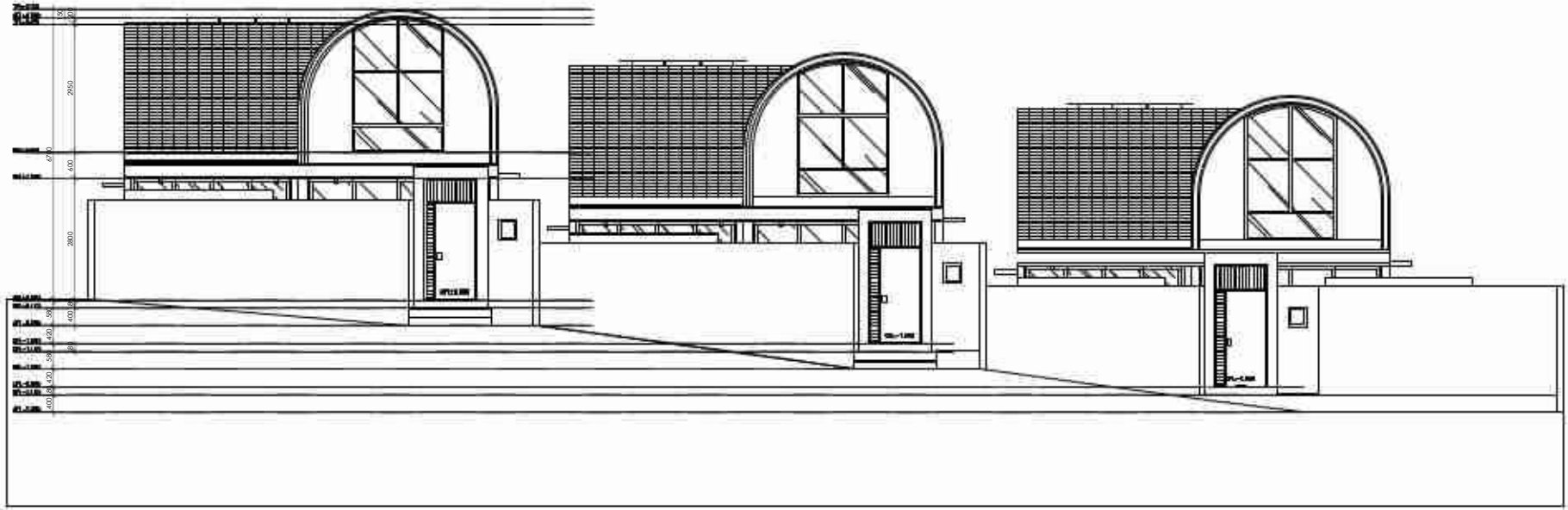

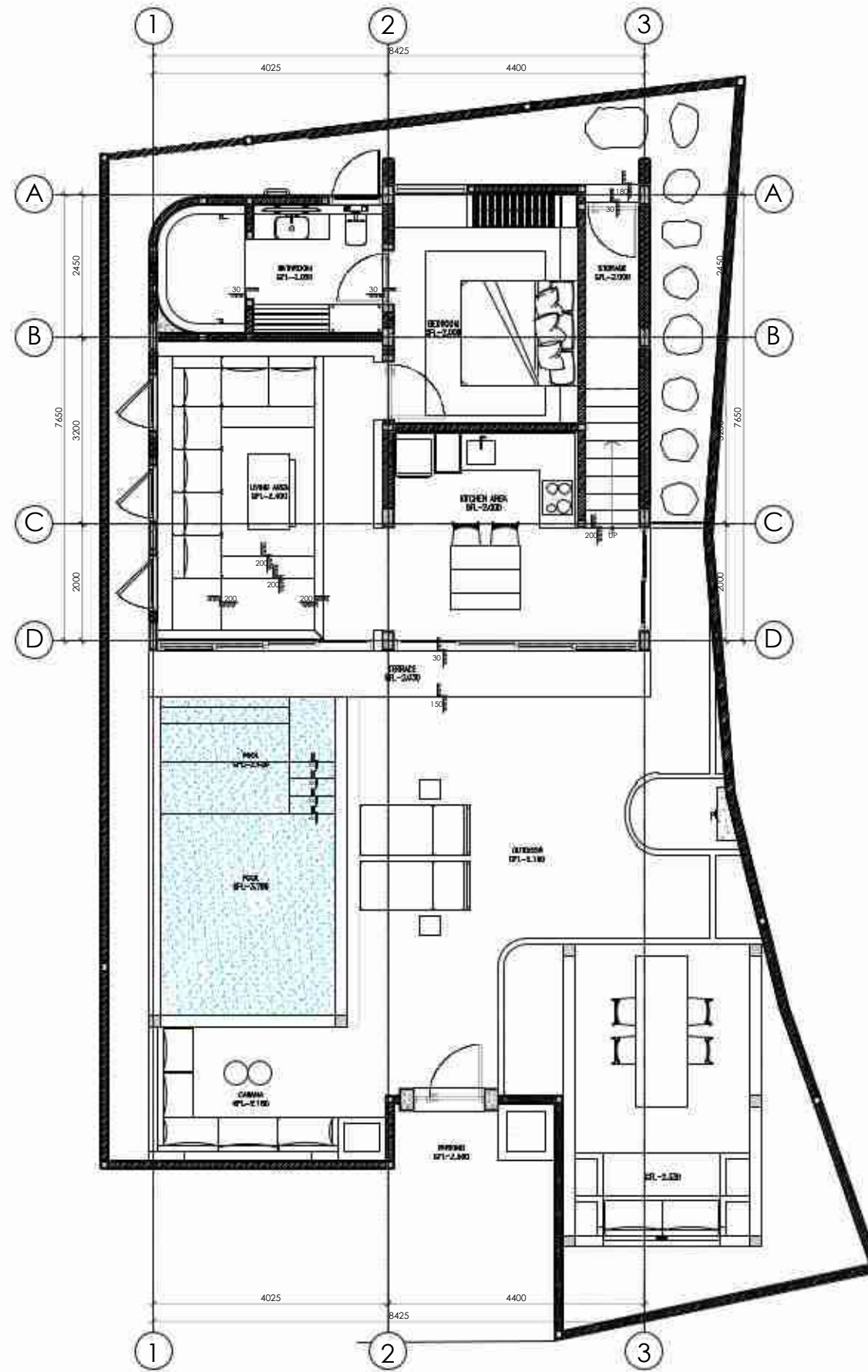

GROUND FLOOR PLAN VILLA A
Scale 1 : 100

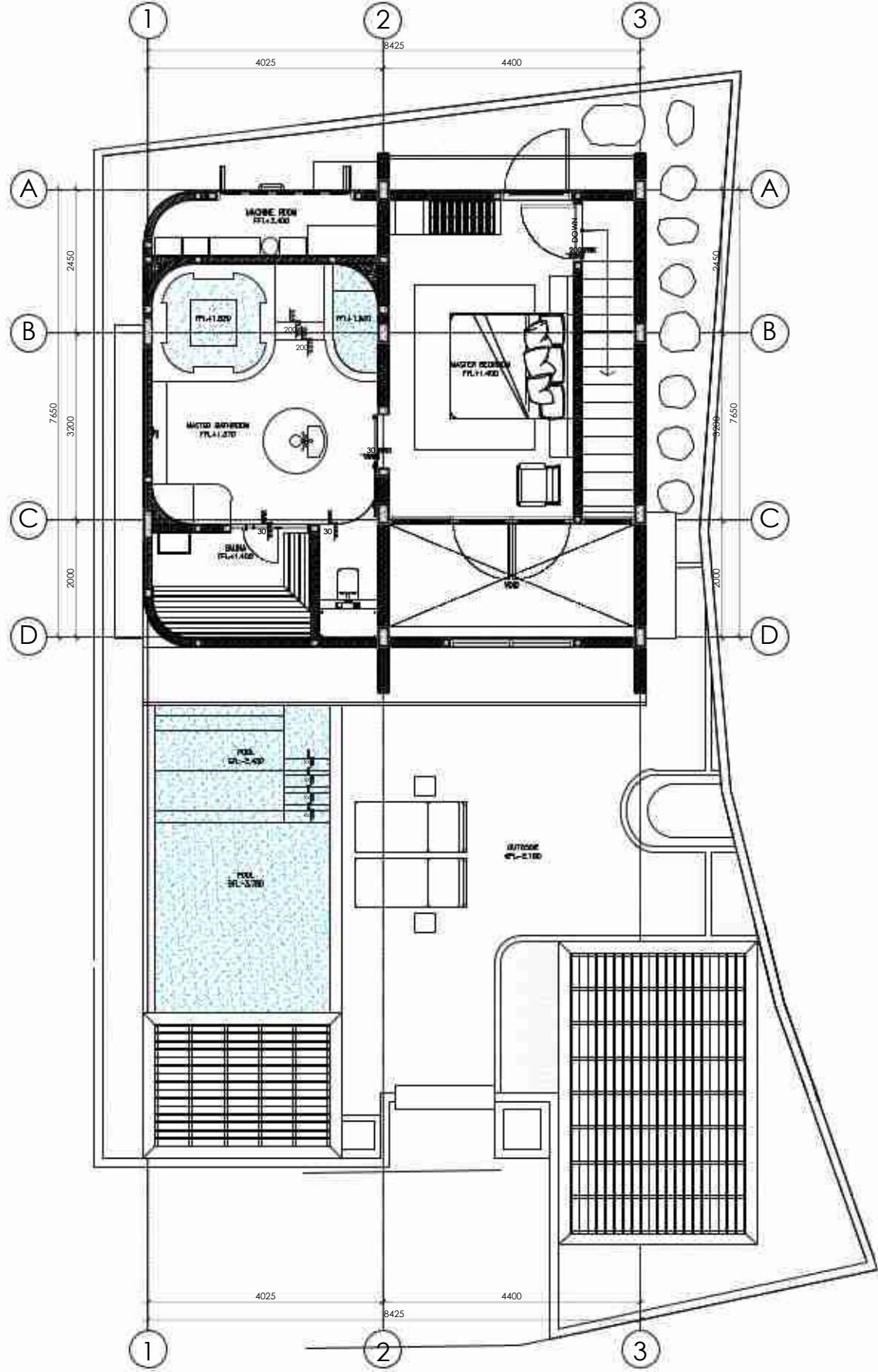

FIRST FLOOR PLAN VILLA A
Scale 1 : 100

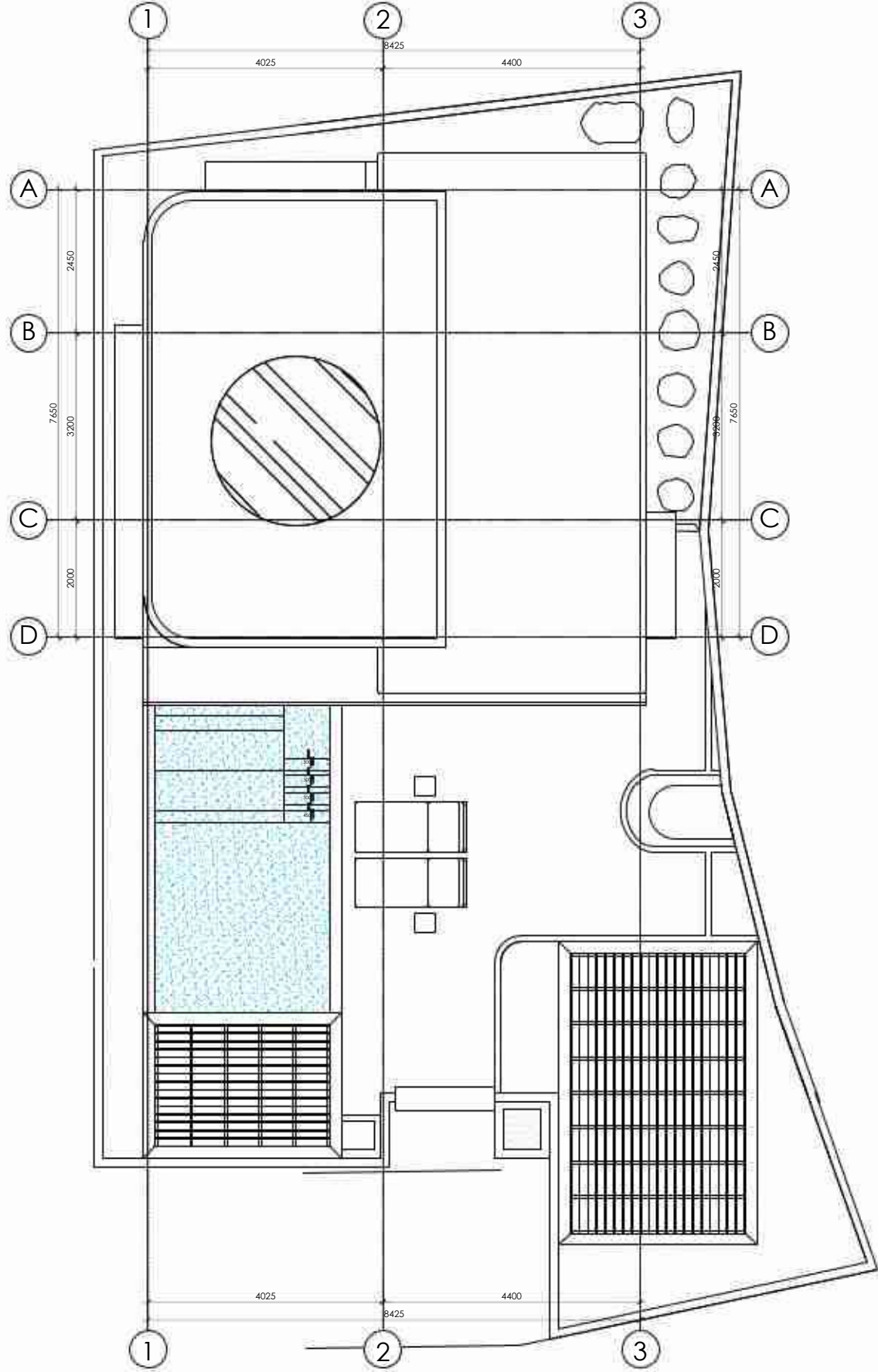

ROOF TOP PLAN VILLA A
Scale 1 : 100

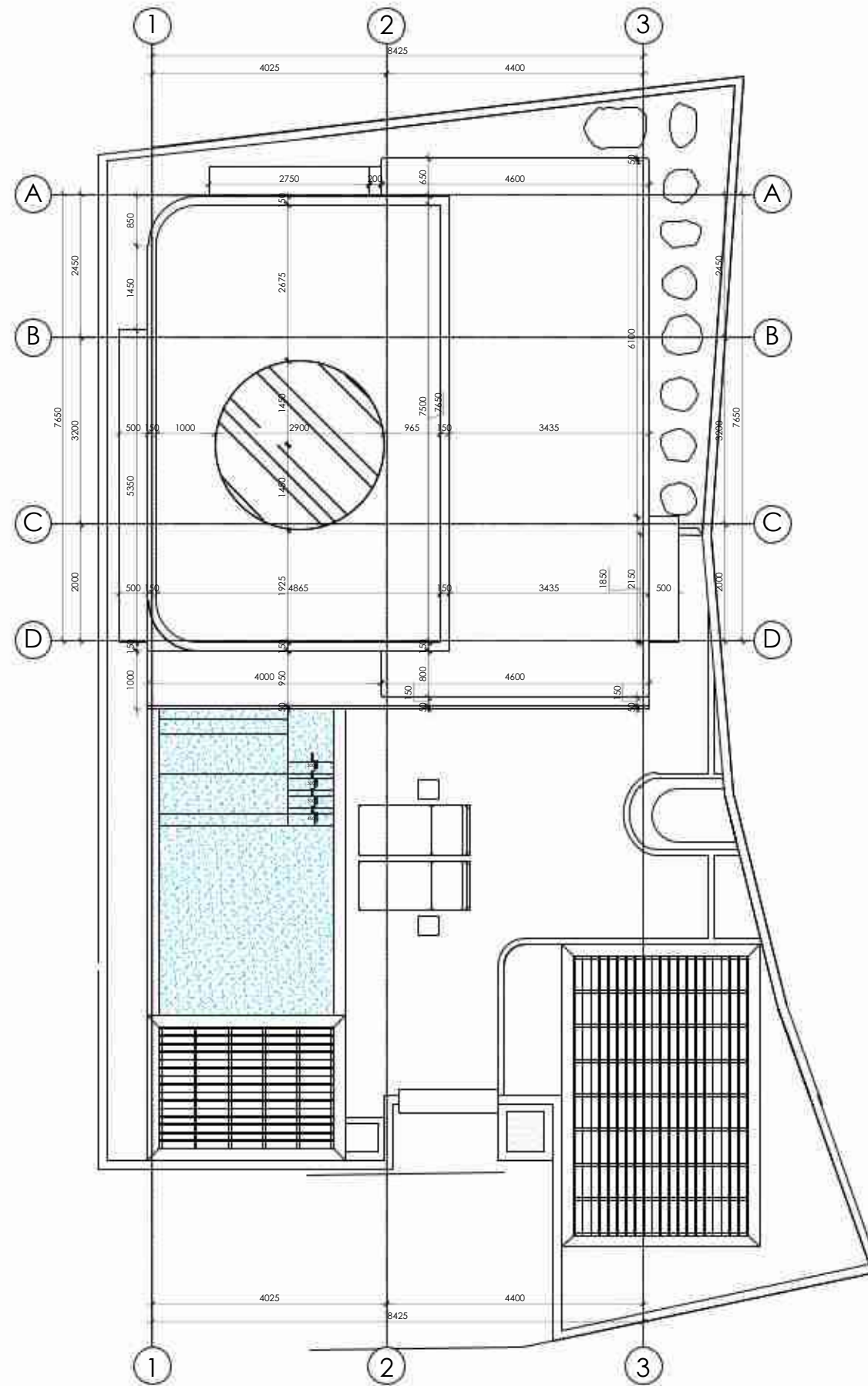

ROOF TOP DIMENSION PLAN VILLA A
Scale 1 : 100

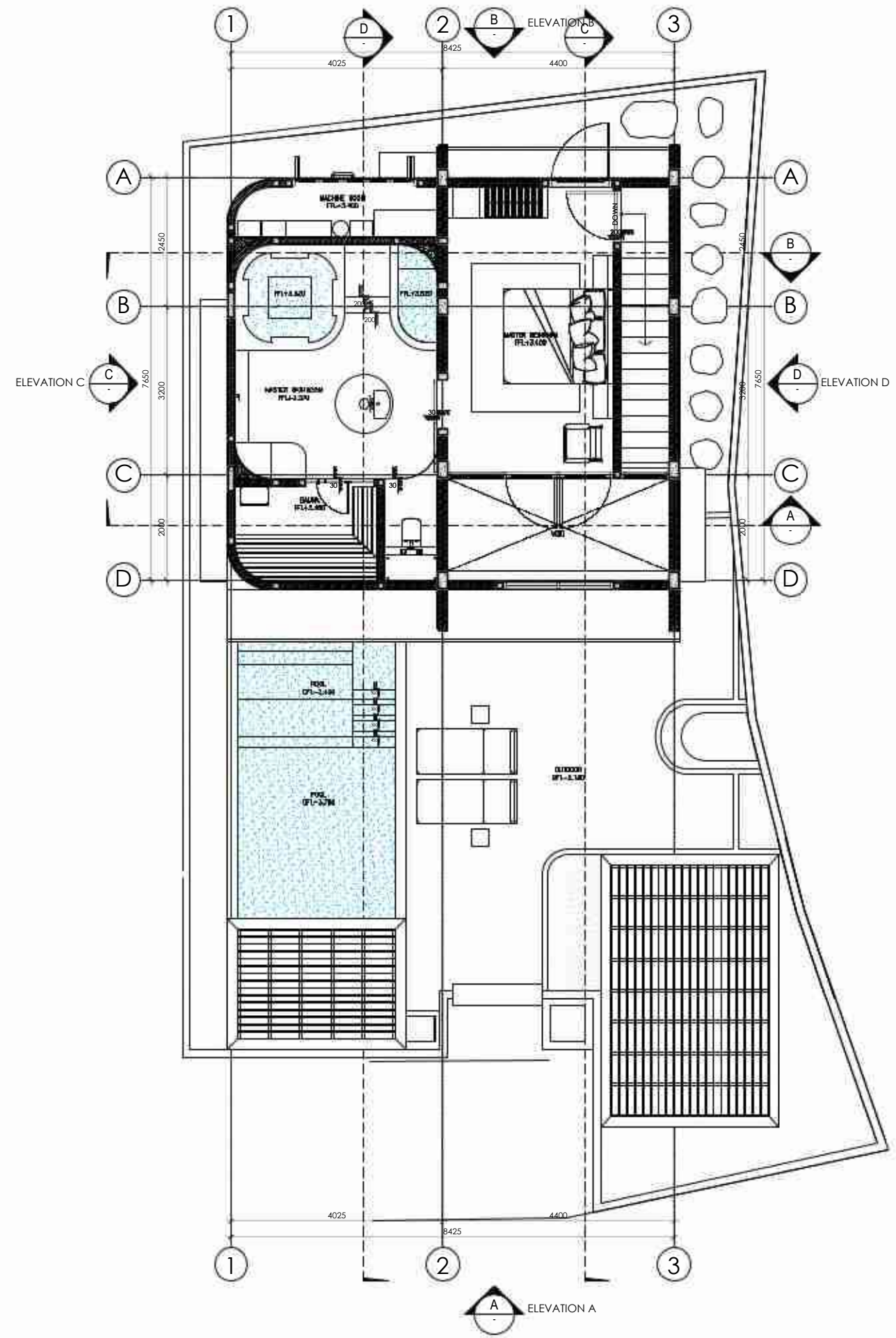
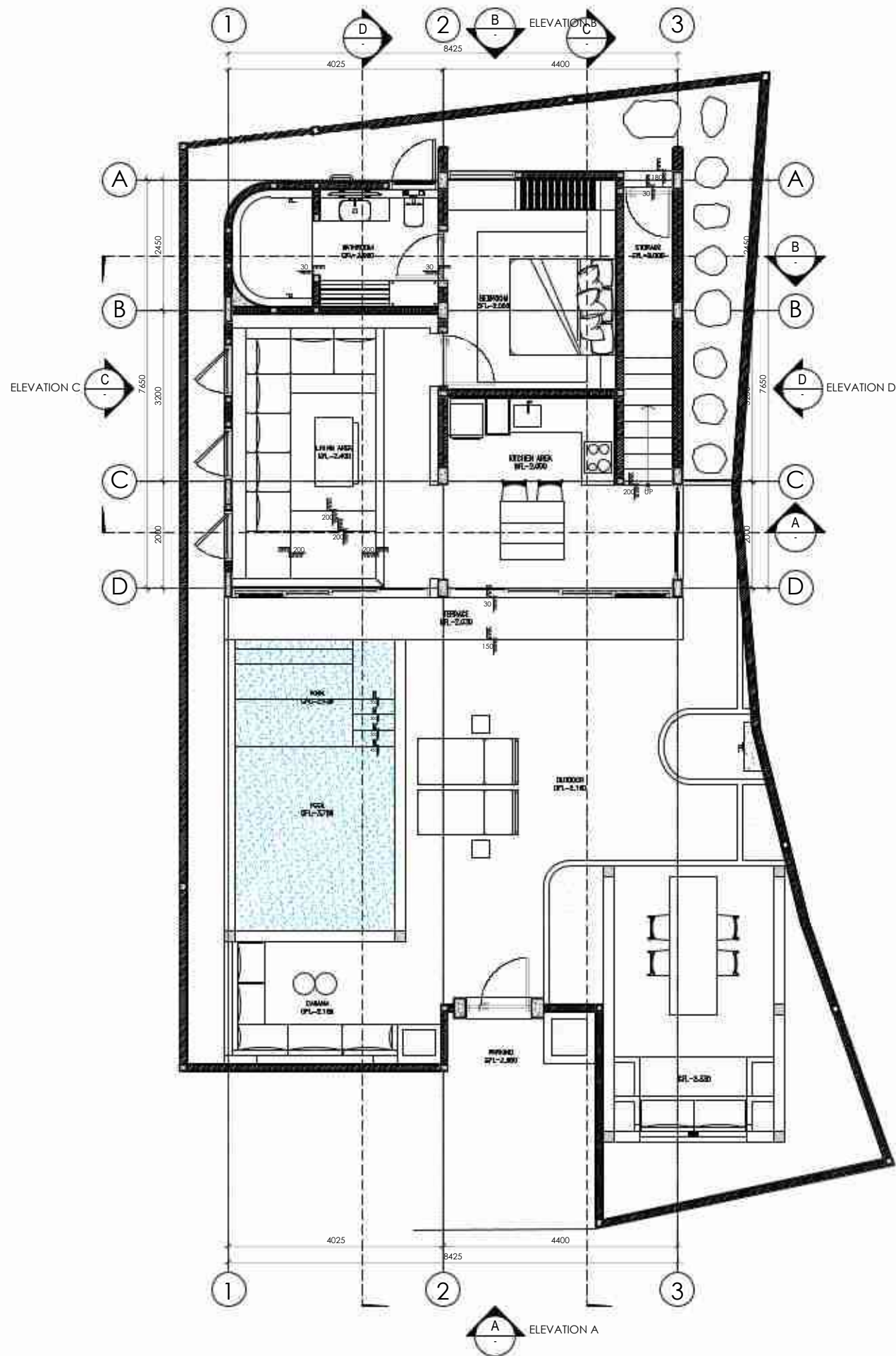

ELEVATION VILLA A
Scale 1 : 100

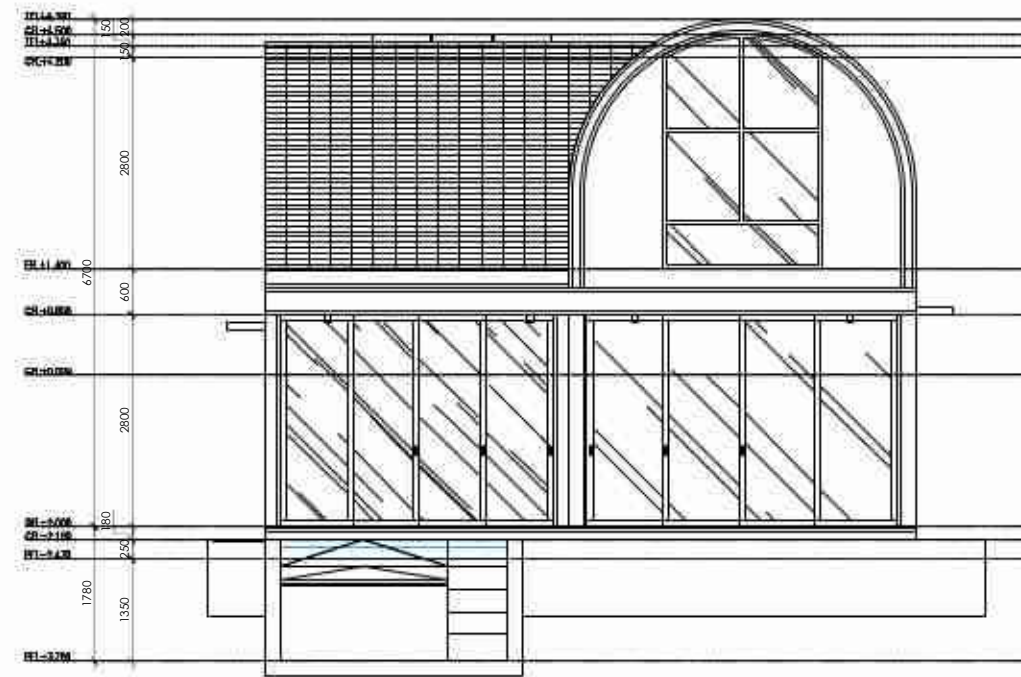
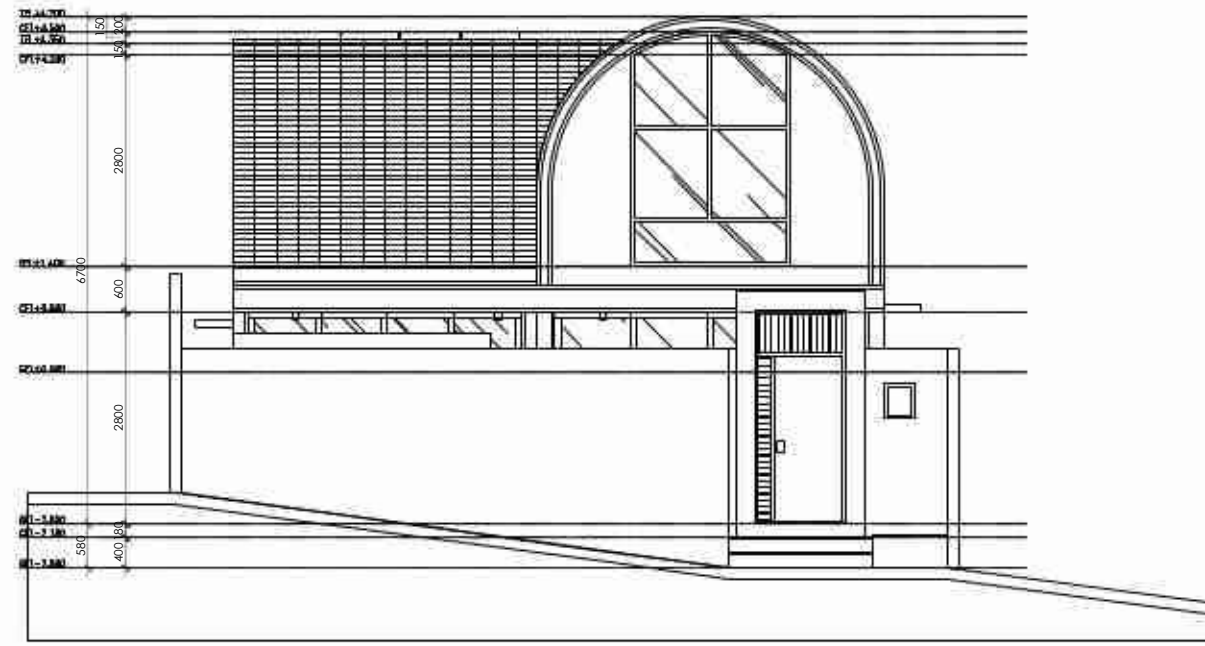

ELEVATION A-A VILLA A
Scale 1 : 100

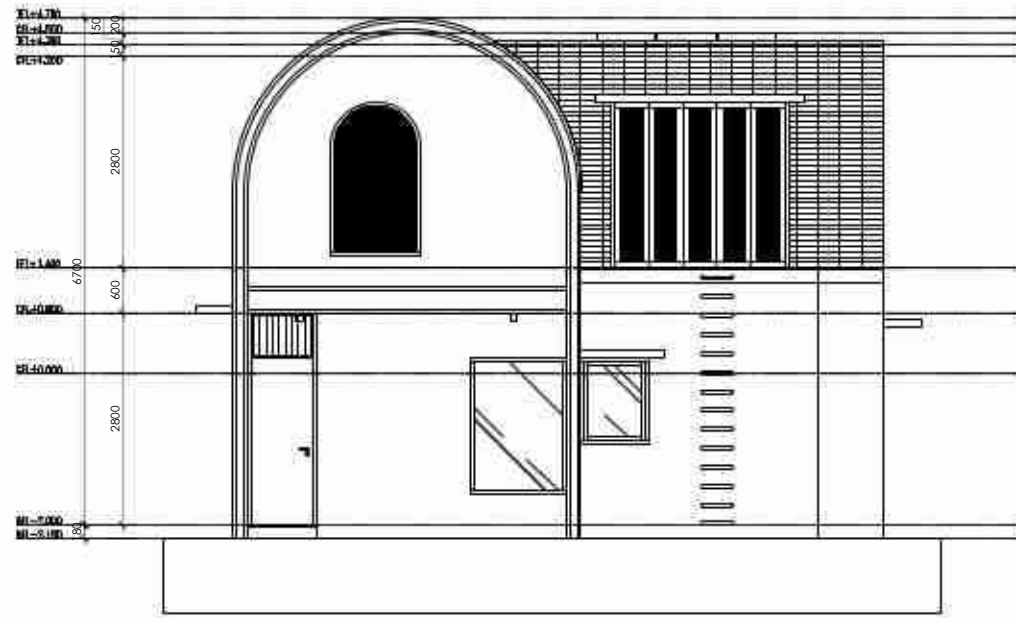
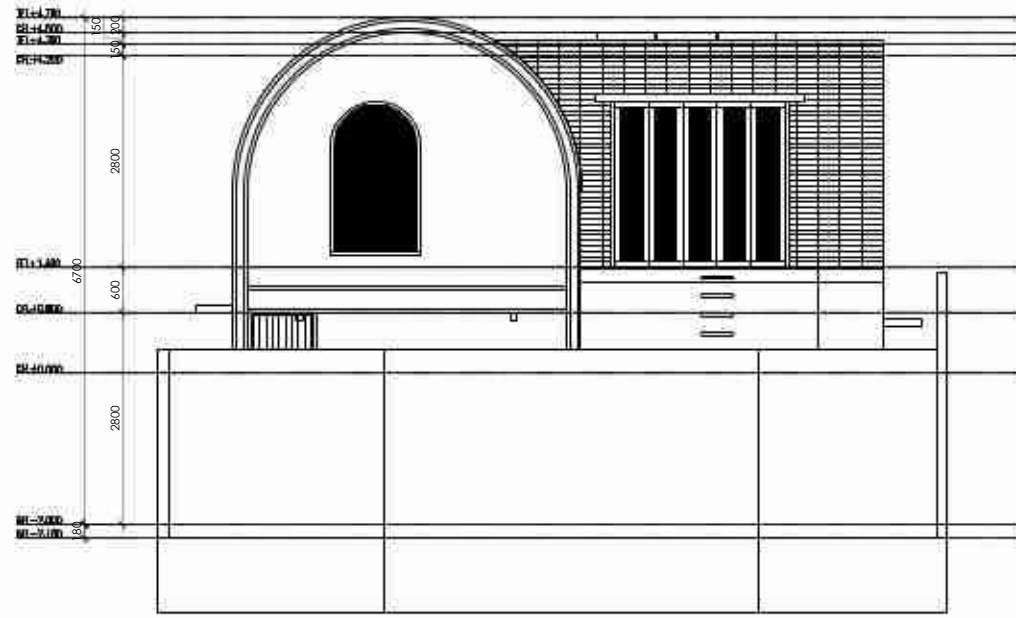

ELEVATION B-B VILLA A
Scale 1 : 100

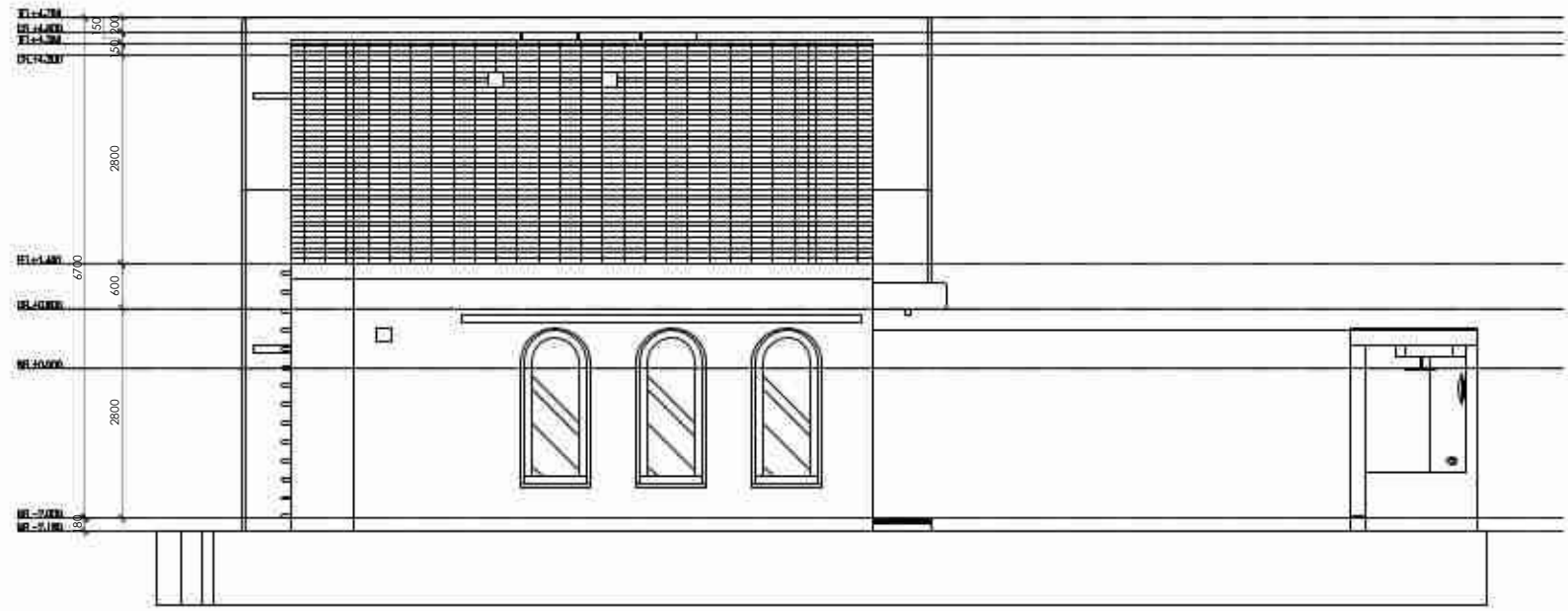
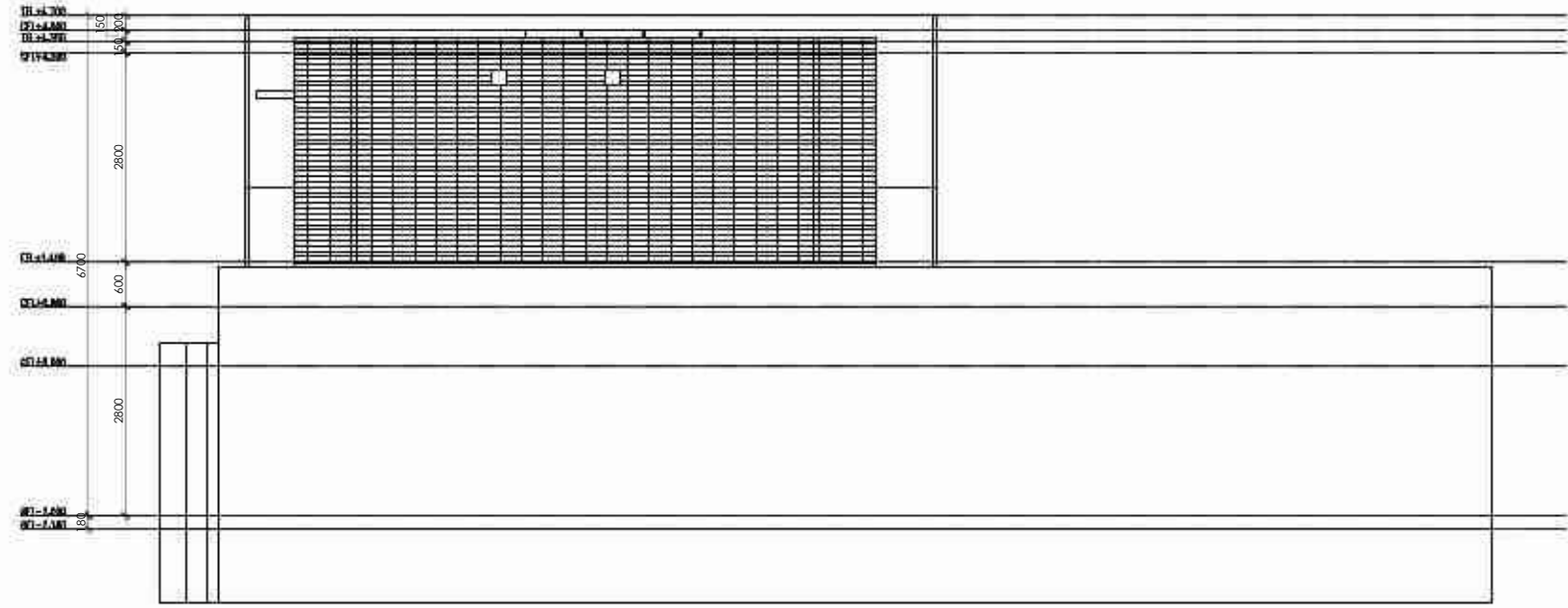

ELEVATION C-C SITE A
Scale 1 : 100

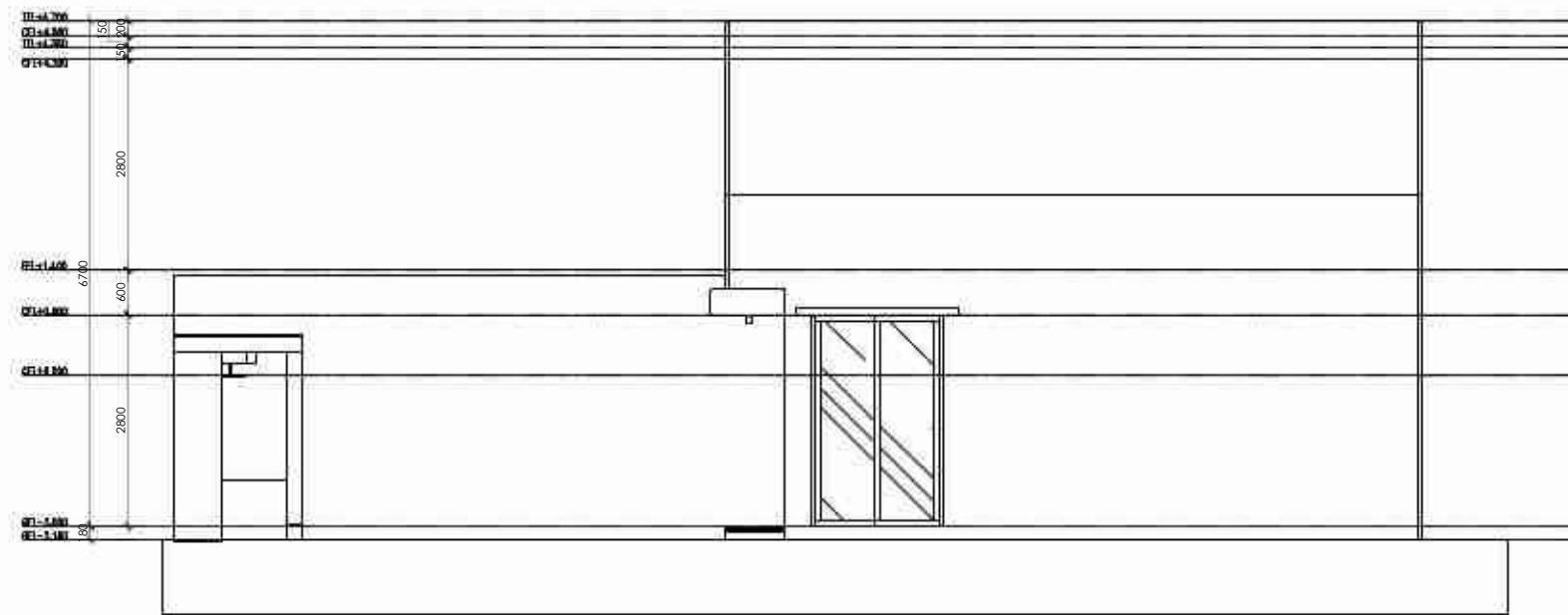
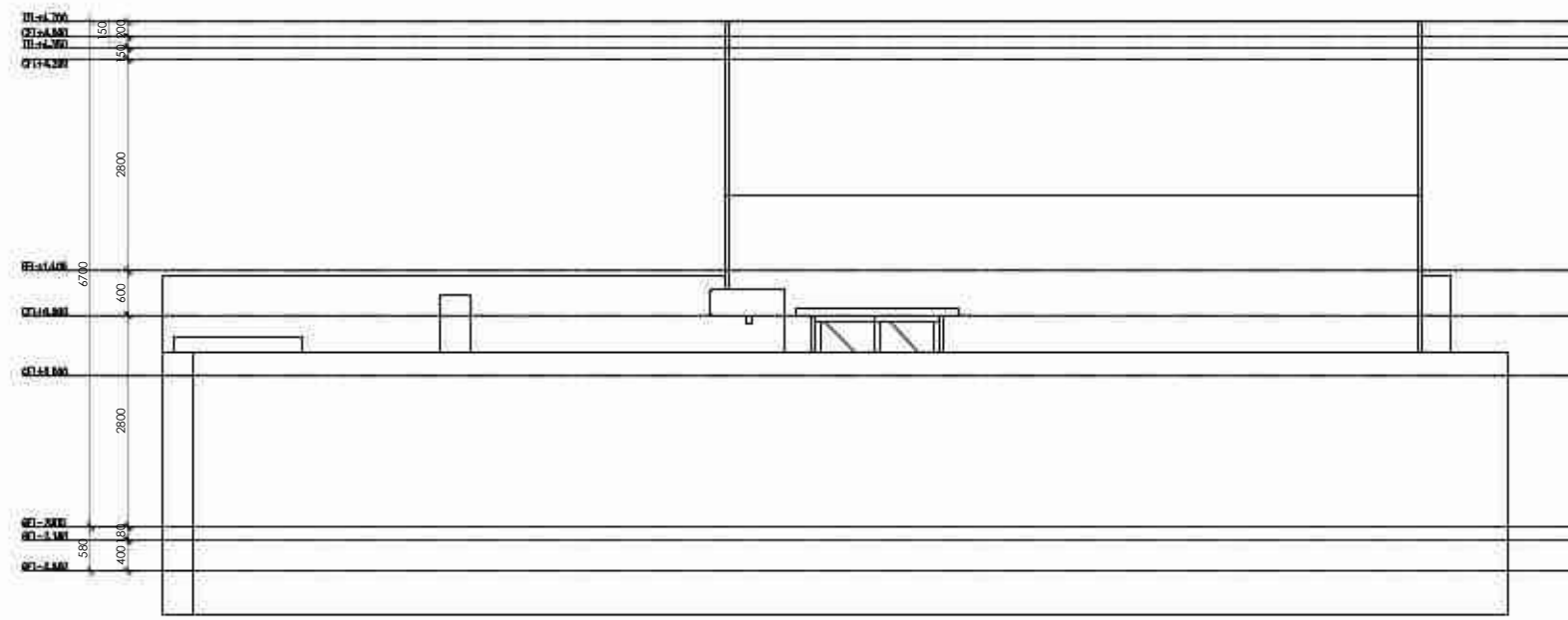

ELEVATION D-D VILLA A
Scale 1 : 100

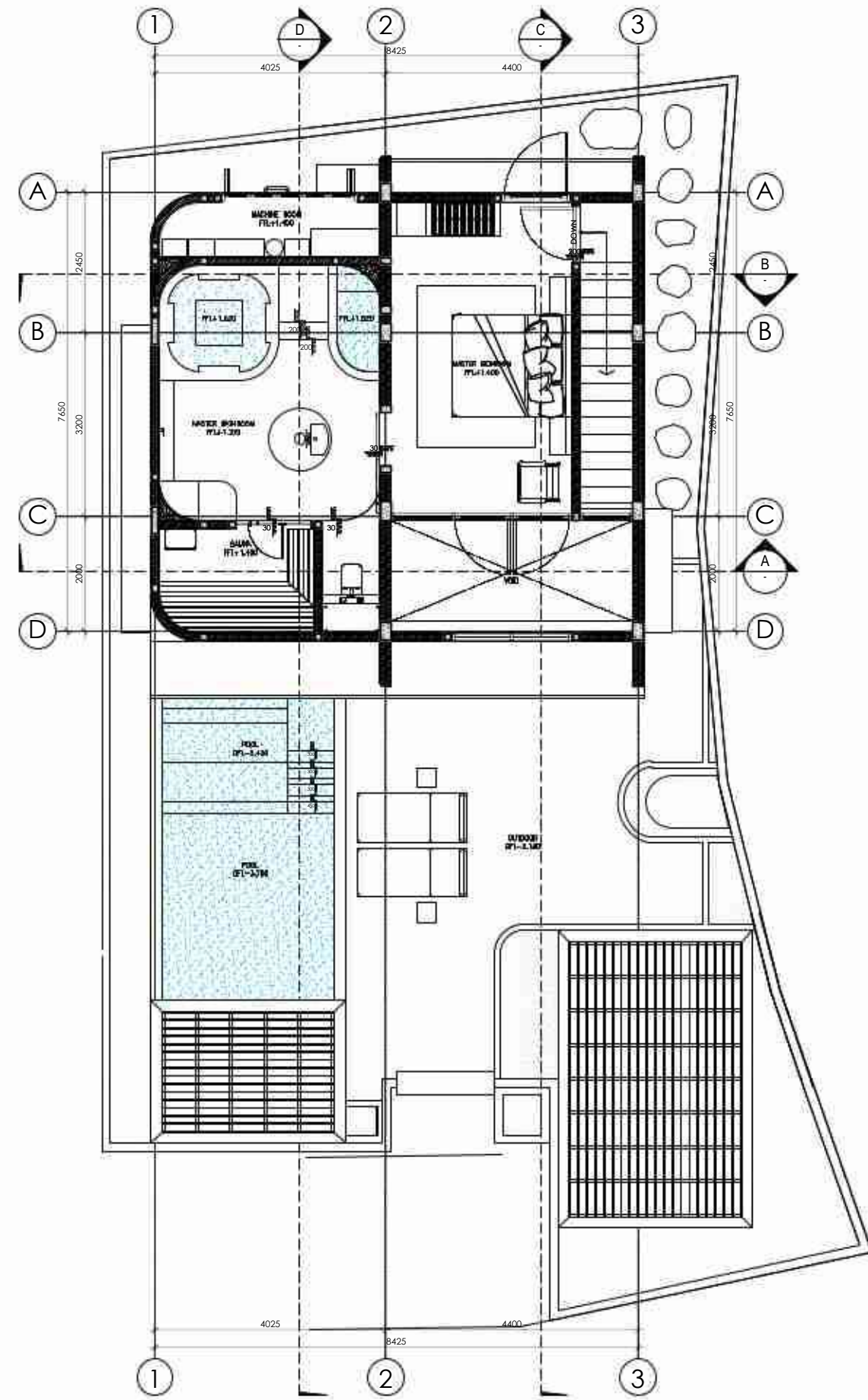
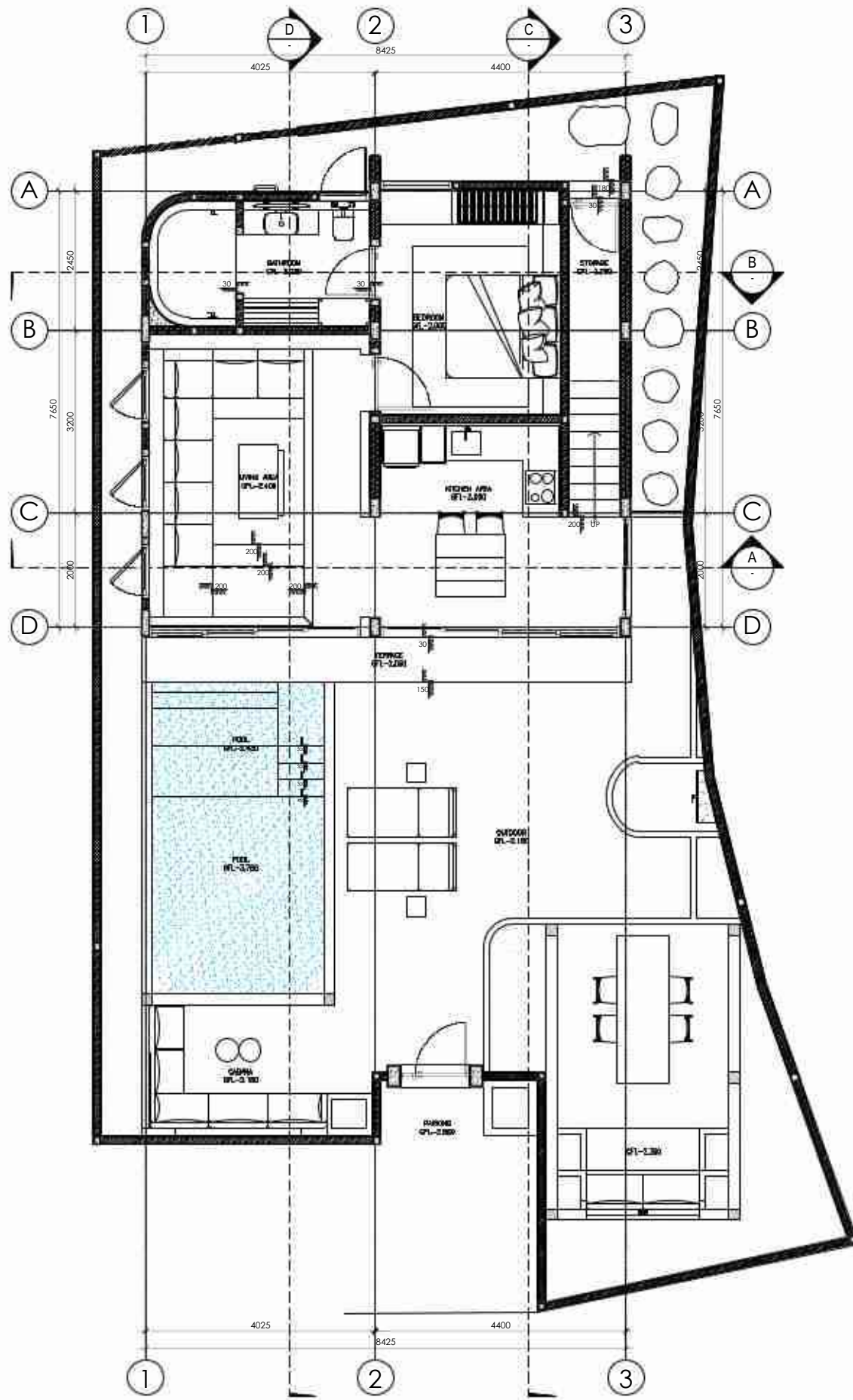

SECTION VILLA A
Scale 1 : 100

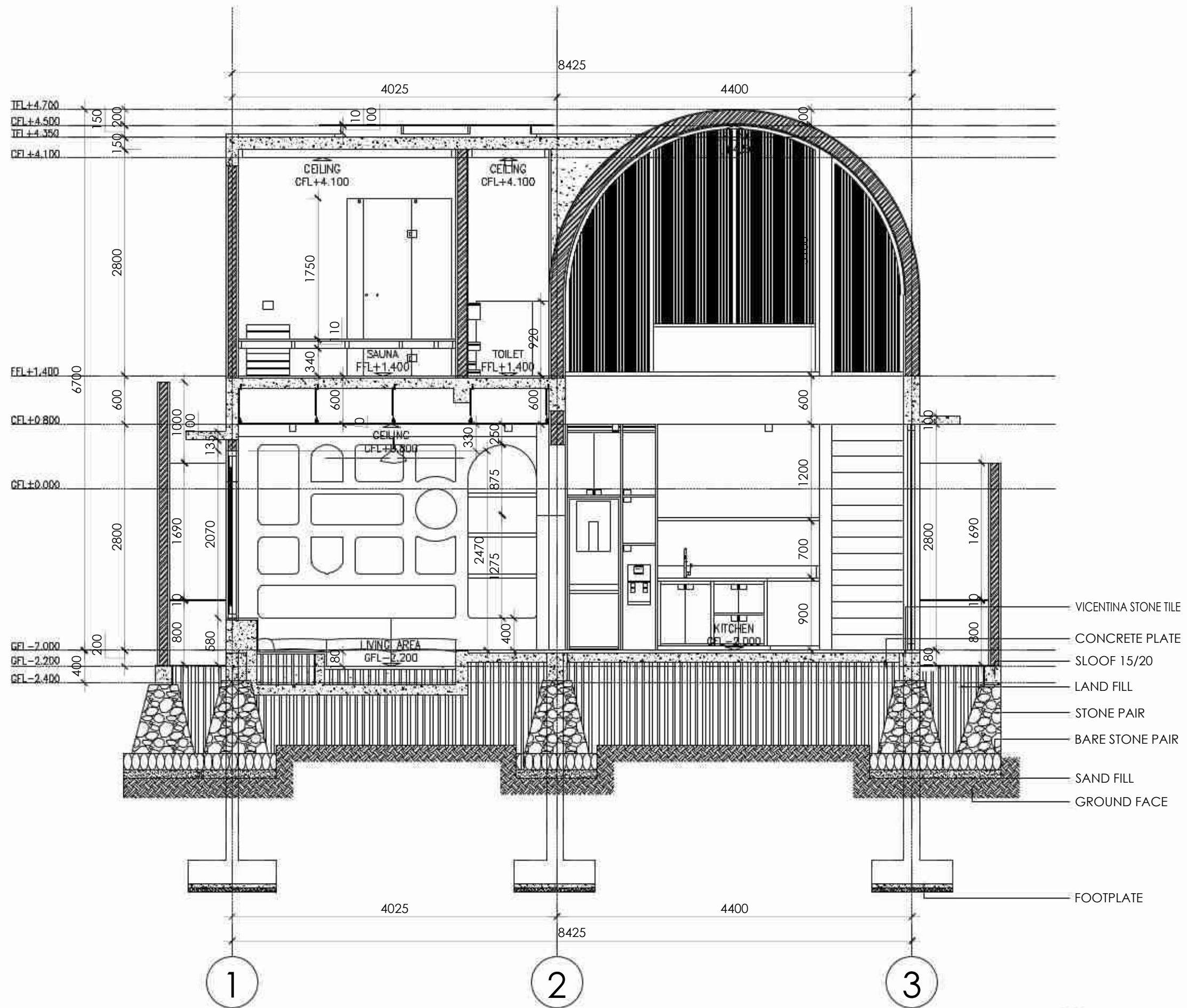

- VICENTINA STONE TILE
- CONCRETE PLATE
- SLOOF 15/20
- LAND FILL
- STONE PAIR
- BARE STONE PAIR
- SAND FILL
- GROUND FACE
- FOOTPLATE

SECTION A-A VILLA A
Scale 1 : 50

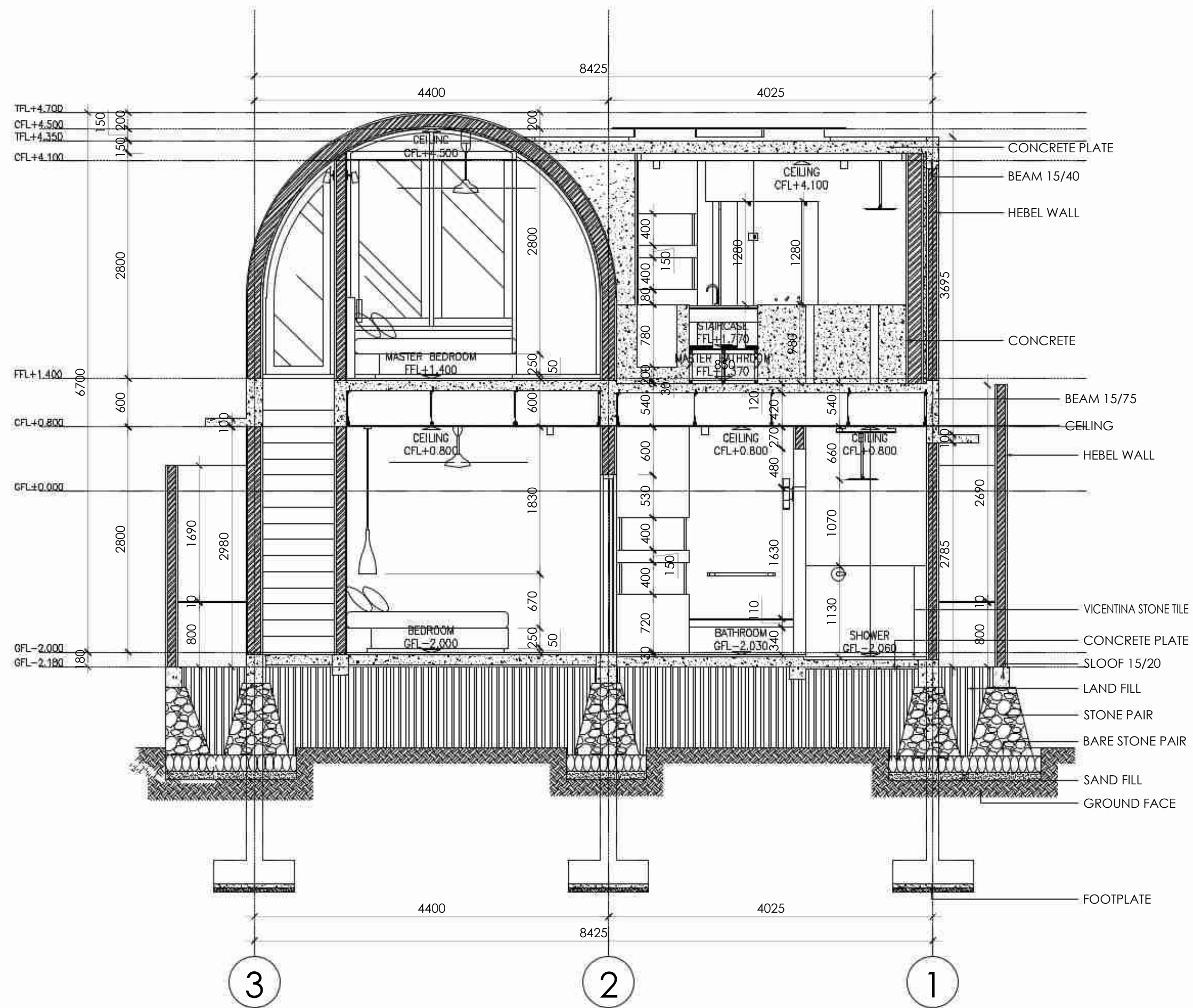

SECTION B-B VILLA A
Scale 1 : 50

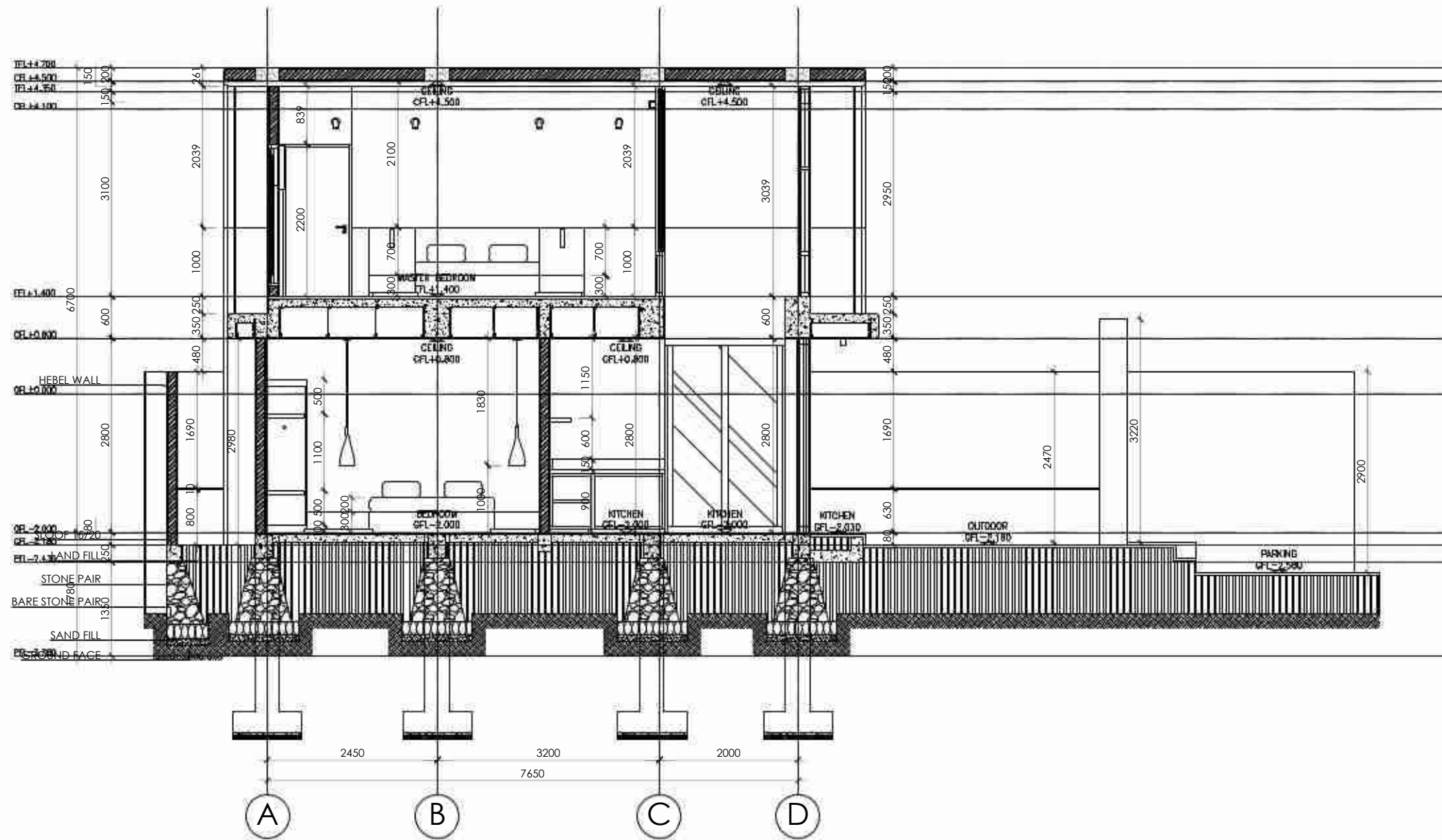

SECTION C-C VILLA A
Scale 1 : 75

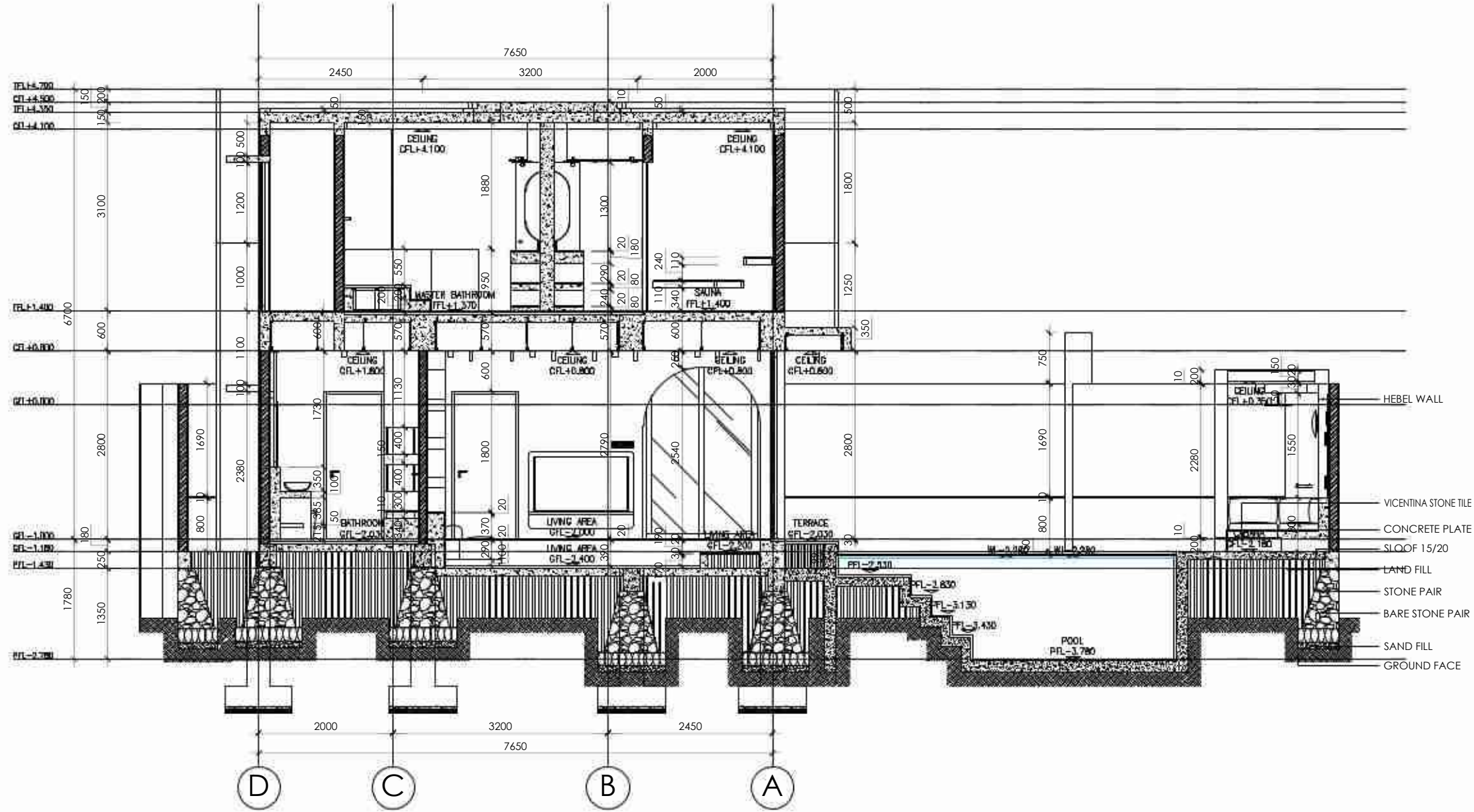

SECTION D-D VILLA A
Scale 1 : 75

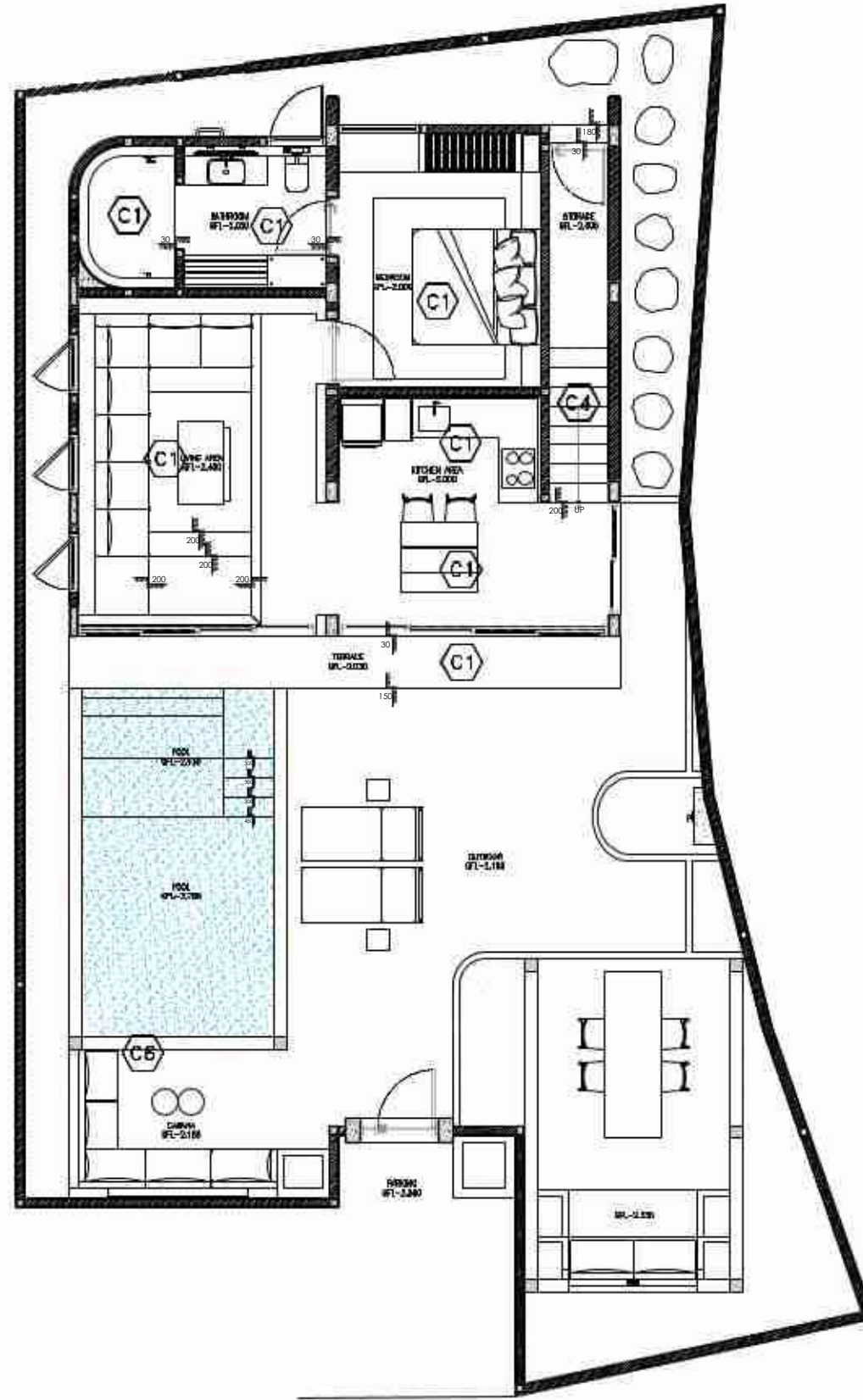

KETERANGAN	
C1	CONCRETE BASE TEXTURE HAZELNUT PAINTING COLOR
C2	MODINO MARBLE TILE
C3	CONCRETE BASE TEXTURE GREY COLOR
C4	CONCRETE BASE TEXTURE PREFER TO MAKE
C5	CONCRETE BASE TEXTURE PREFER TO MAKE
C6	TEAK WOOD FIN BRAK MALIKUT
C7	SPECIAL BRICKS
C8	TERRAZZO SURFACE

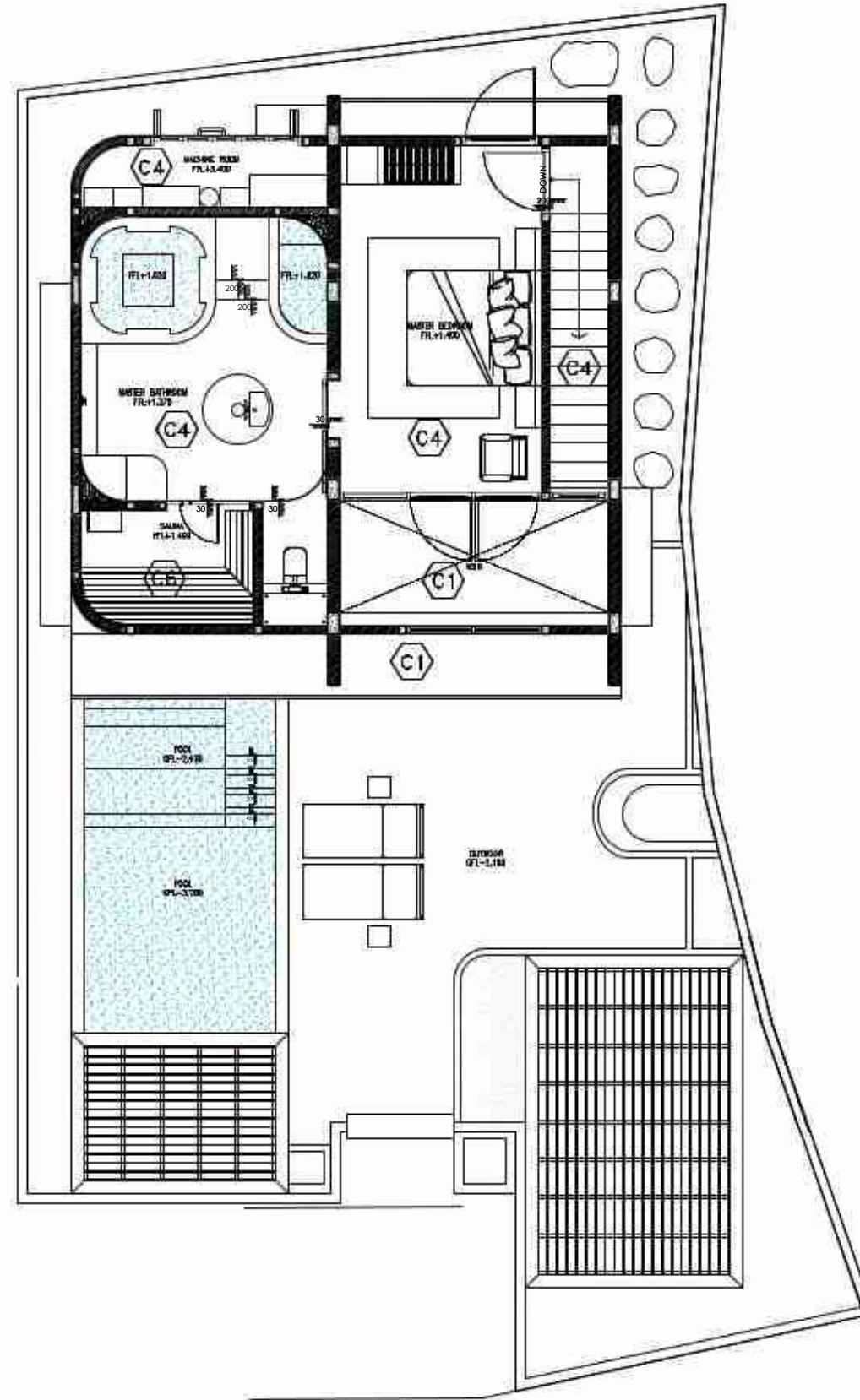

KETERANGAN	
C1	CONCRETE BARE TEXTURE HAZELNUT PAINTING COLOR
C2	MODERN MARBLE TILE
C3	CONCRETE BARE TEXTURE GREY COLOR
C4	CONCRETE BARE TEXTURE PREFER TO MAKE
C5	CONCRETE BARE TEXTURE PREFER TO MAKE
C6	TEAK WOOD FIN ORAK MALIKUT
C7	SPECIAL BRICKS
C8	TERRAZZO SURFACE

MATERIAL SCHEDULE CEILING FIRST FLOOR PLAN VILLA A
Scale 1 : 100

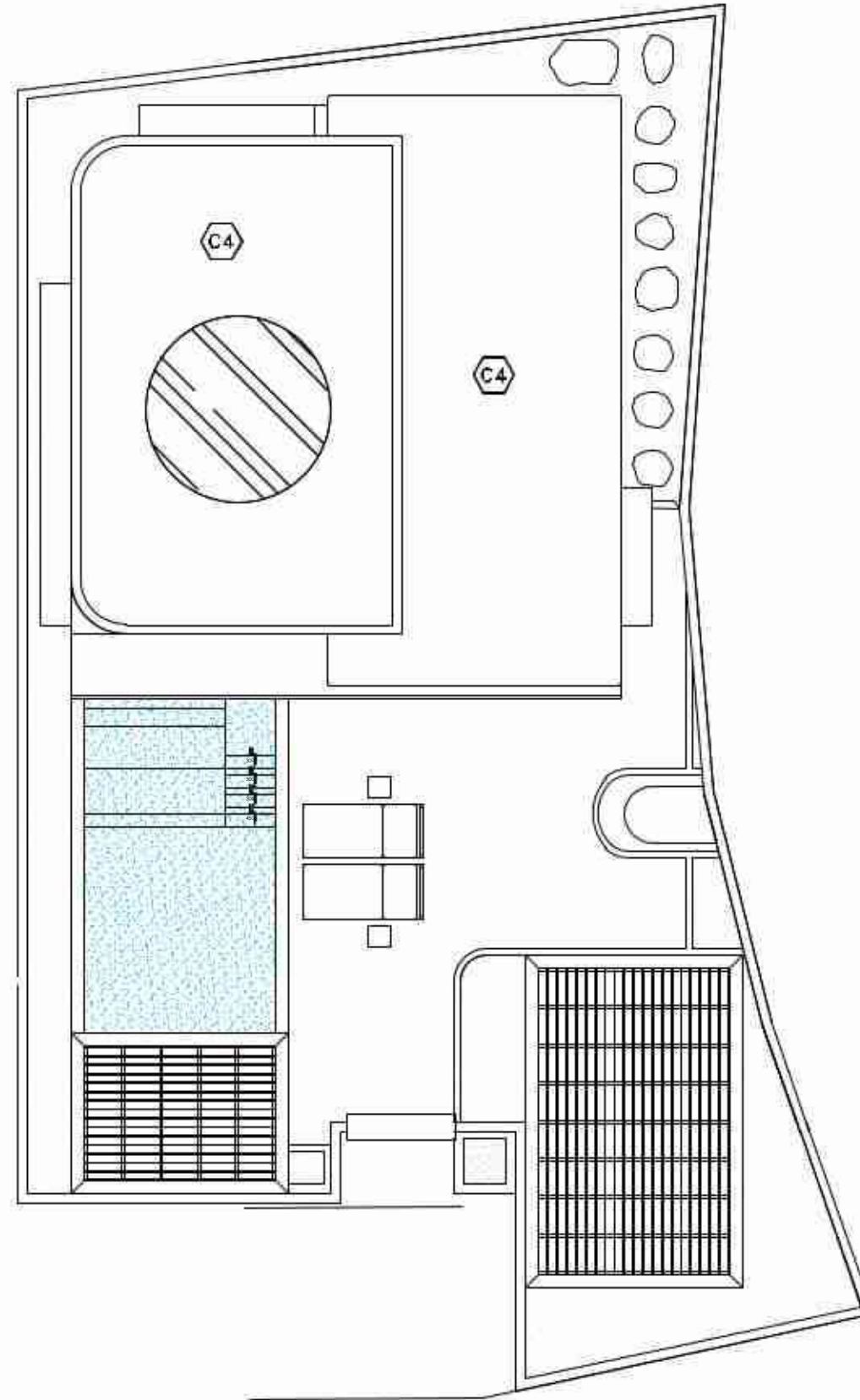

KETERANGAN	
C1	CONCRETE BARE TEXTURE HAZELNUT PAINTING COLOR
C2	MODINO MARBEL TILE
C3	CONCRETE BARE TEXTURE GREY COLOR
C4	CONCRETE BARE TEXTURE PREFER TO MAKE
C5	CONCRETE BARE TEXTURE PREFER TO MAKE
C6	TEAK WOOD FIN ORAK WALIUT
C7	SPECIAL BRICKS
C8	TERTULAN Duplek

MATERIAL SCHEDULE CEILING ROOF TOP PLAN VILLA A
Scale 1 : 100

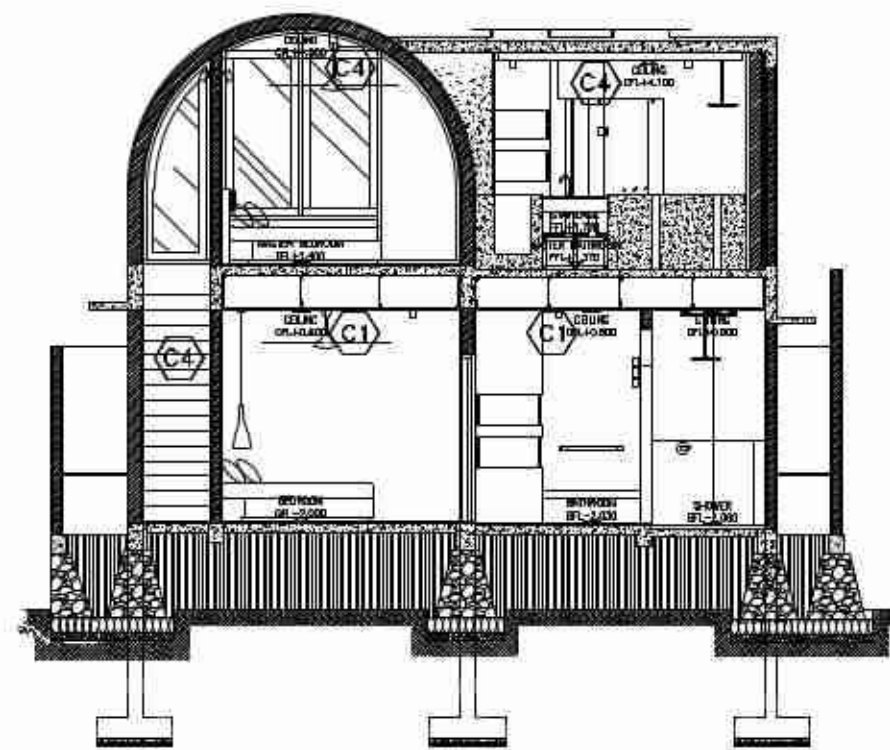
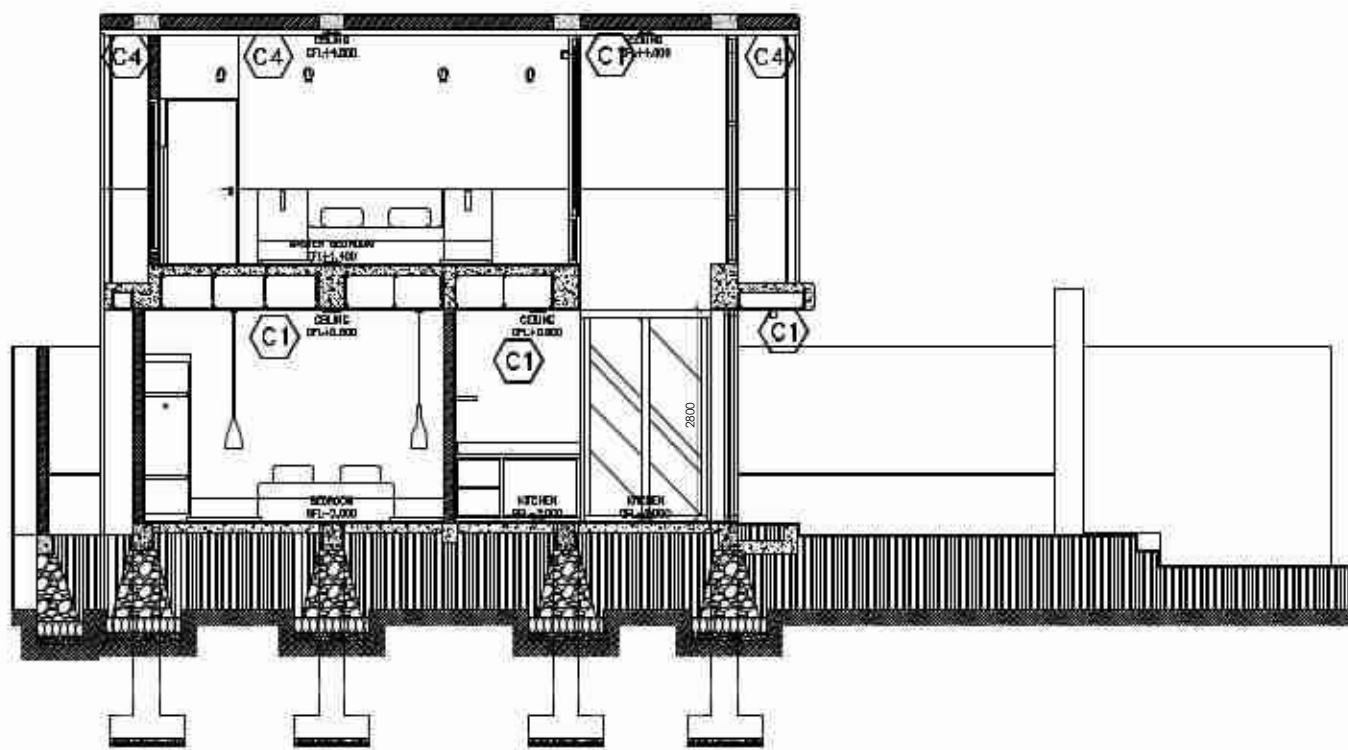
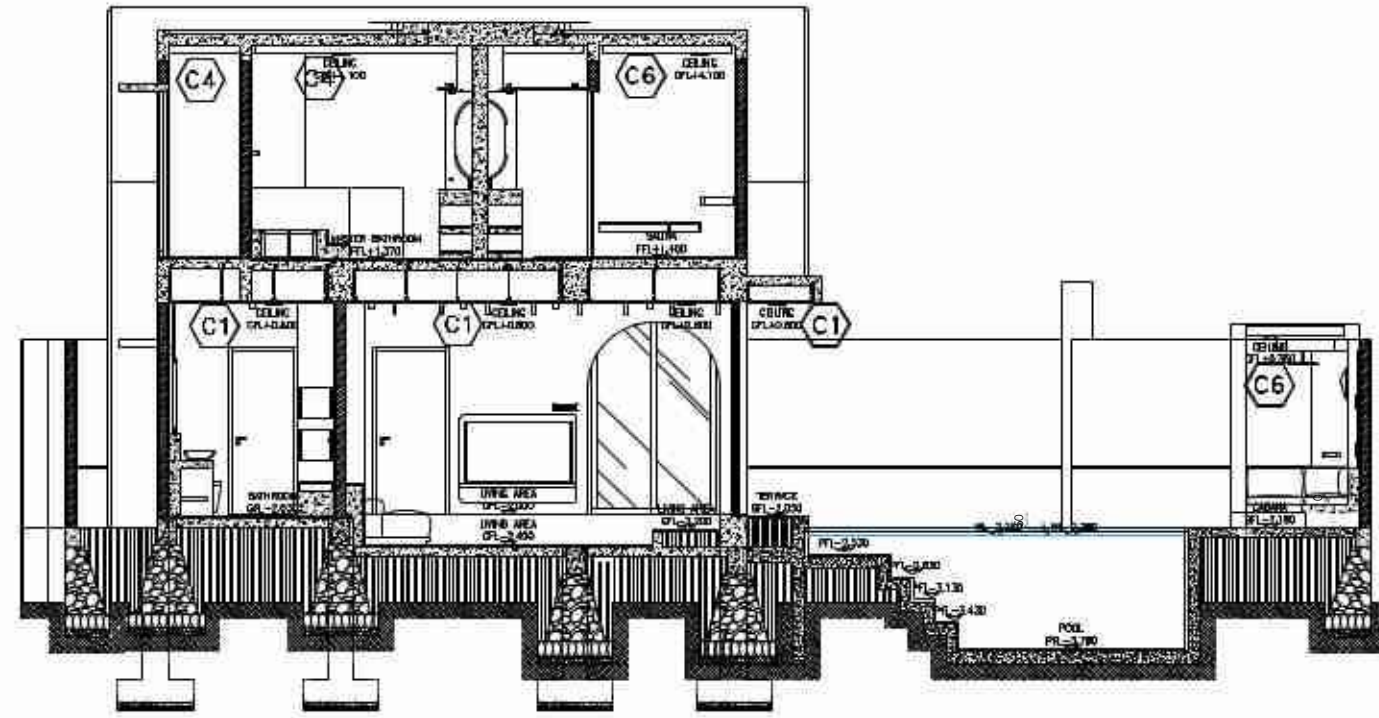
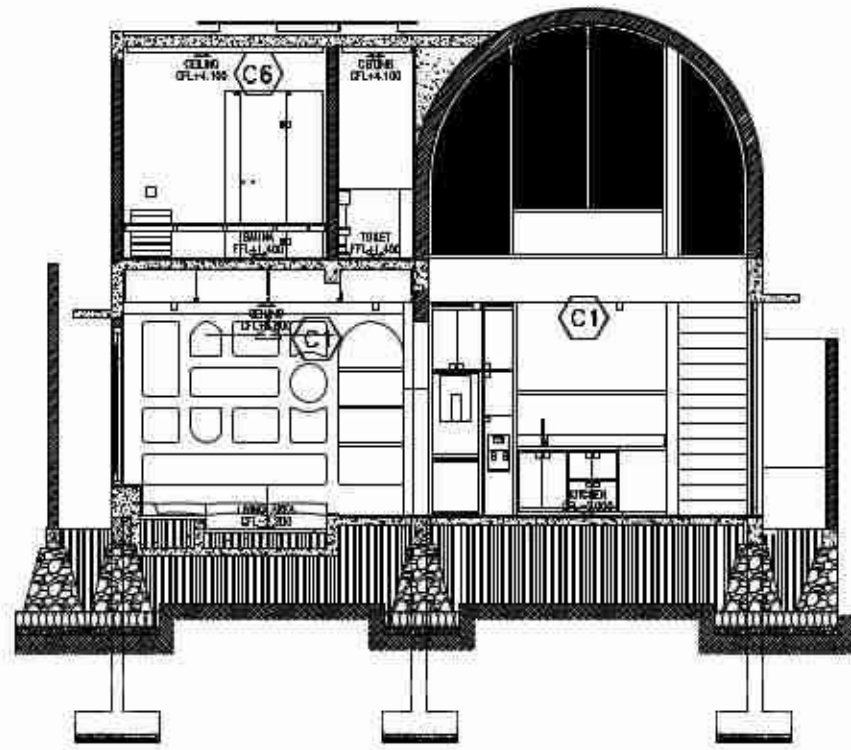

KETERANGAN	
(C1)	CONCRETE BARE TEXTURE HAZARDAT PANTONE COLOR
(C2)	MIXING MARBEL TILE
(C3)	CONCRETE BARE TEXTURE GREY GILOR
(C4)	CONCRETE BARE TEXTURE PREFER TO IMAGE
(C5)	CONCRETE BARE TEXTURE PREFER TO IMAGE
(C6)	TEAK WOOD FIN DARK WAKAT
(C7)	SPECIAL BRICKS
(C8)	TERRAZZO SURFACE

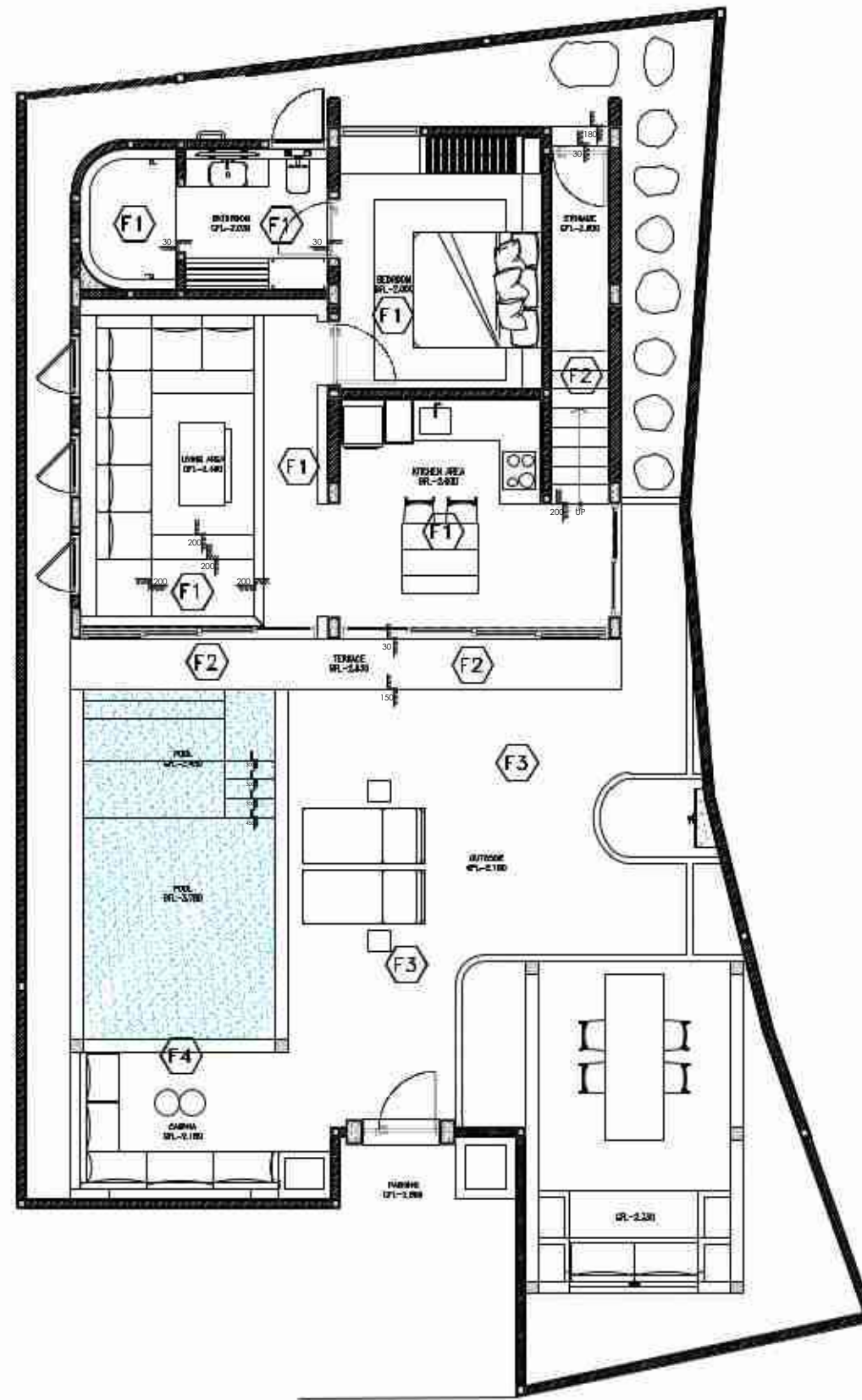

KETERANGAN	
F1	WALNUT STONE TILE
F2	SPECIAL BRICKS
F3	PORFIDO DRAINING CEMENTSTONE
F4	CONCRETE BARE TEXTURE GREY COLOR
F5	TEAK BAKED FINISH WALNUT

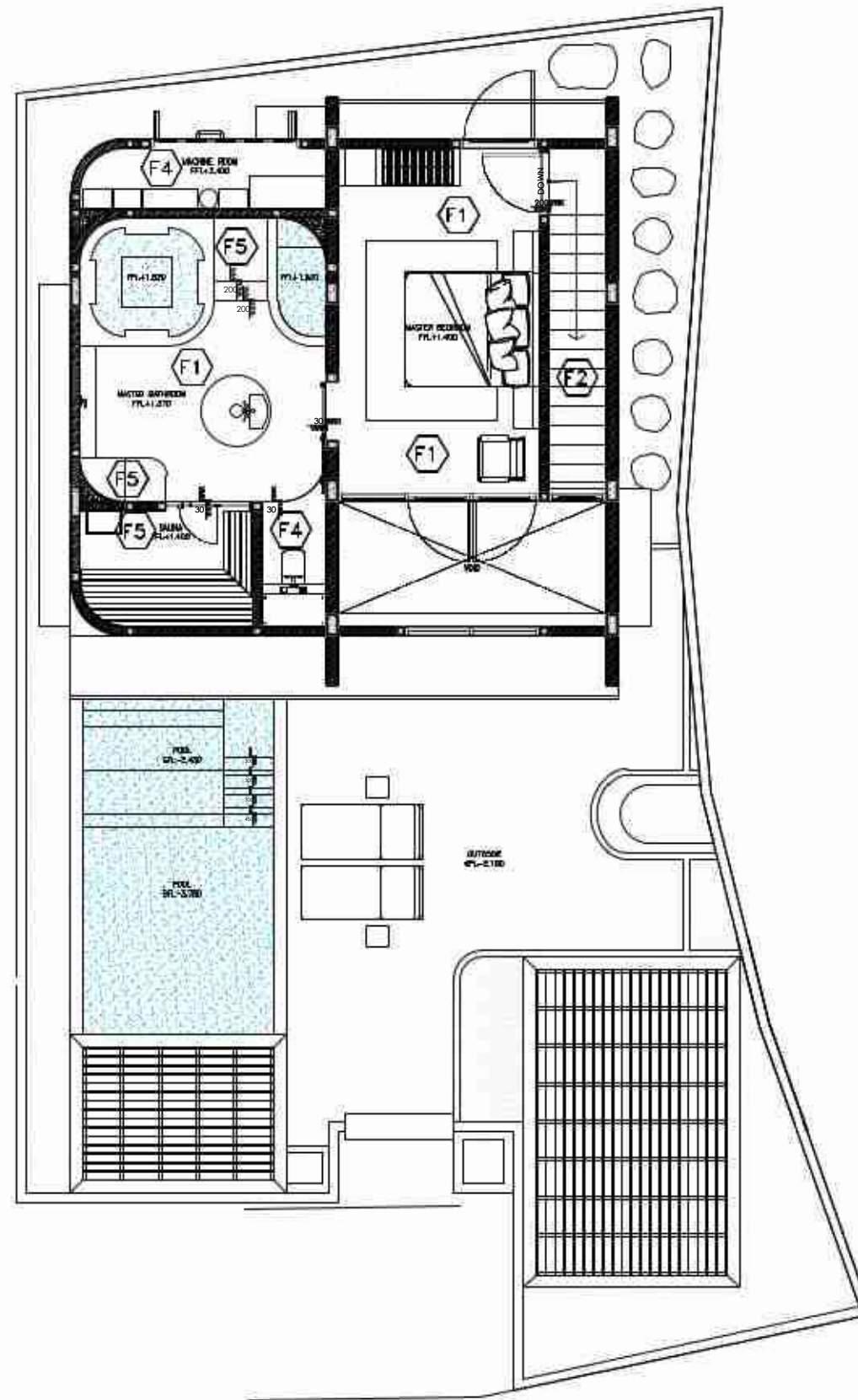

KETERANGAN	
F1	MOODURA STONE TILE
F2	SPECIAL BRICKS
F3	PORTICO DAVINCI CEMENTSTONE
F4	CONCRETE BARE TEXTURE GREY COLOR
F5	TEAK BOARD FINISH WALNUT

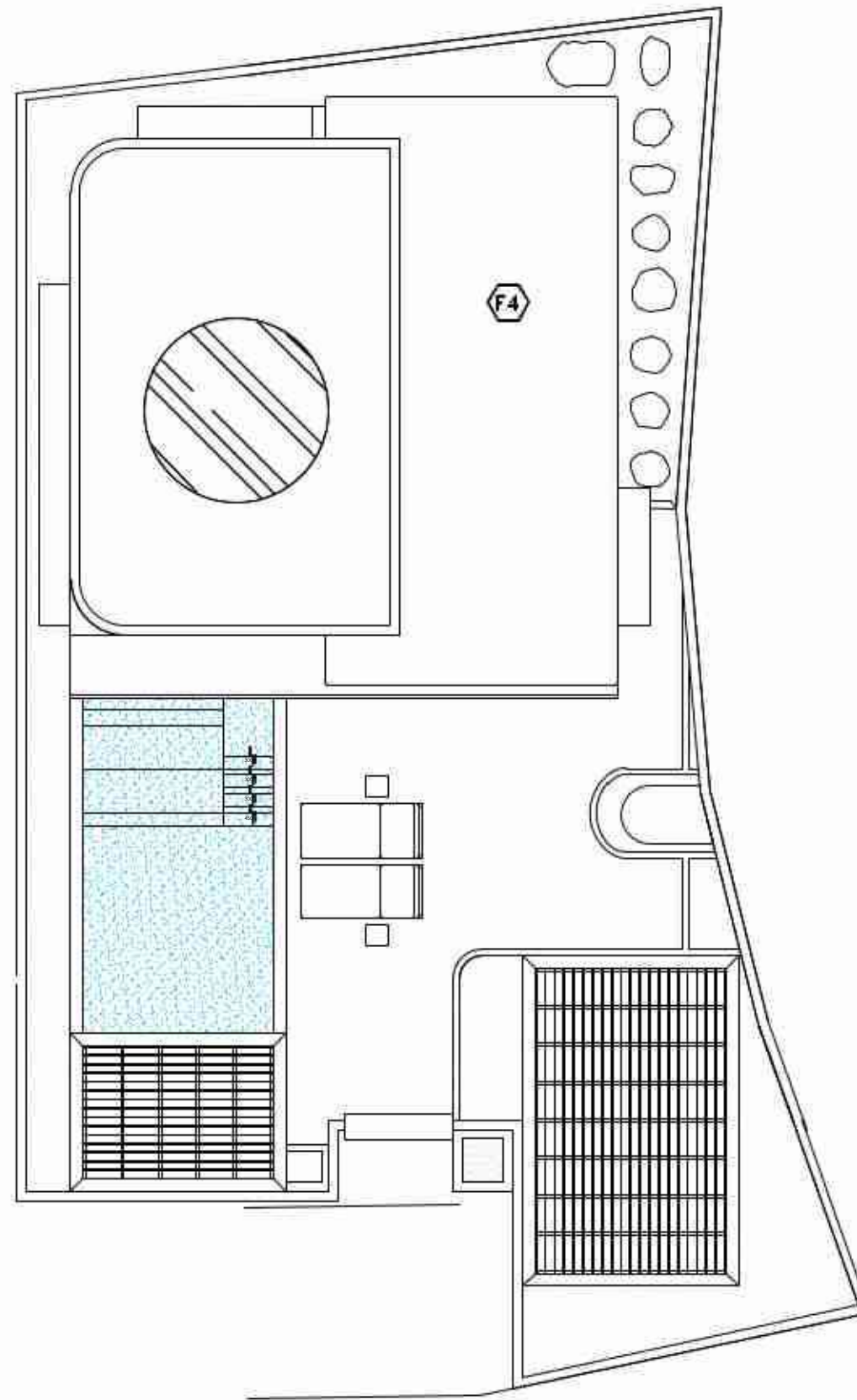

KETERANGAN	
F1	VICENTINI STONE TILE
F2	SPECIAL BRICKS
F3	PORTICO DAVINCI CARRLESTONE
F4	CONCRETE BASE TEXTURE GREY DOLDR
F5	TEAK BOARD FIN 100MM WALKUT

MATERIAL SCHEDULE ROOF TOP VILLA A
Scale 1 : 100

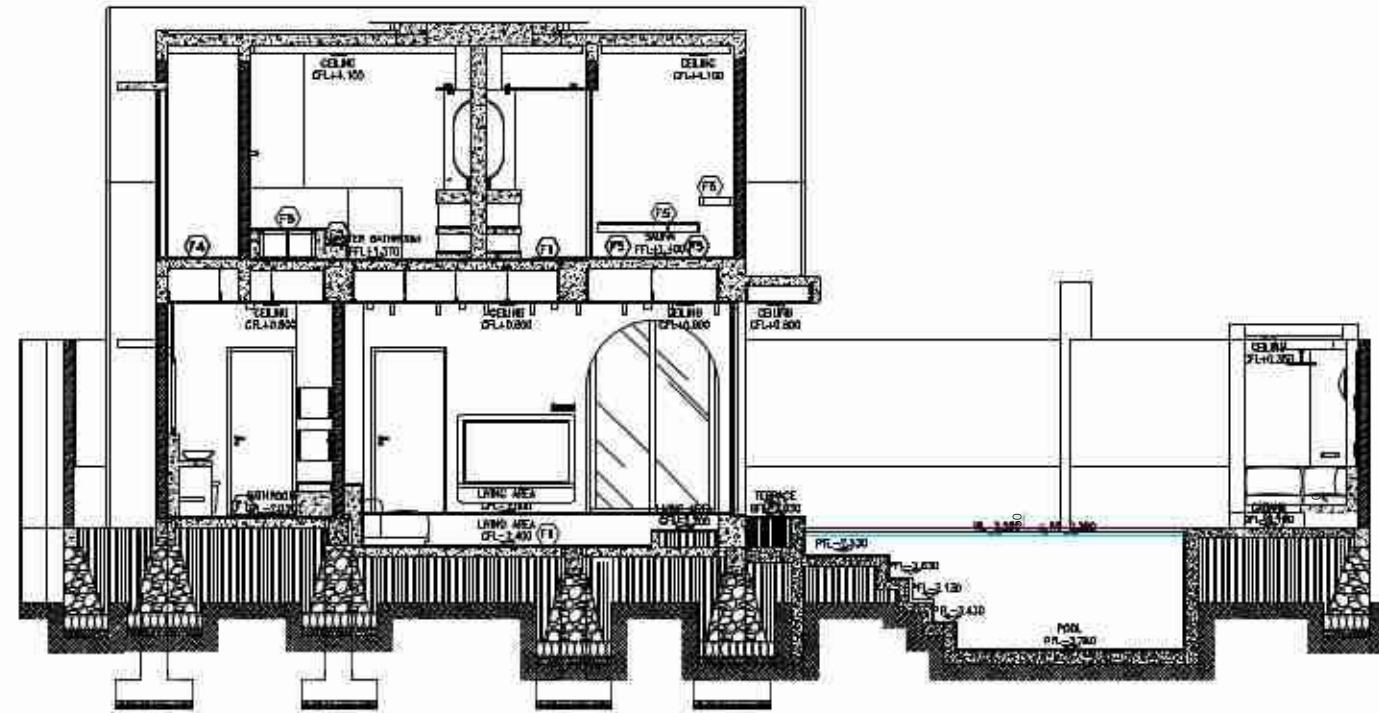
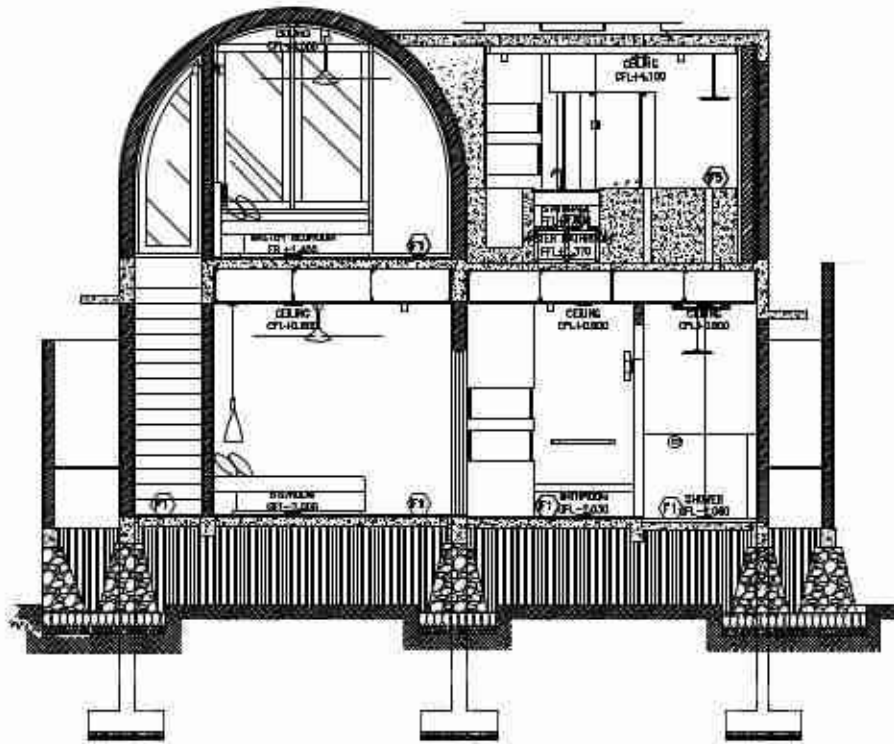
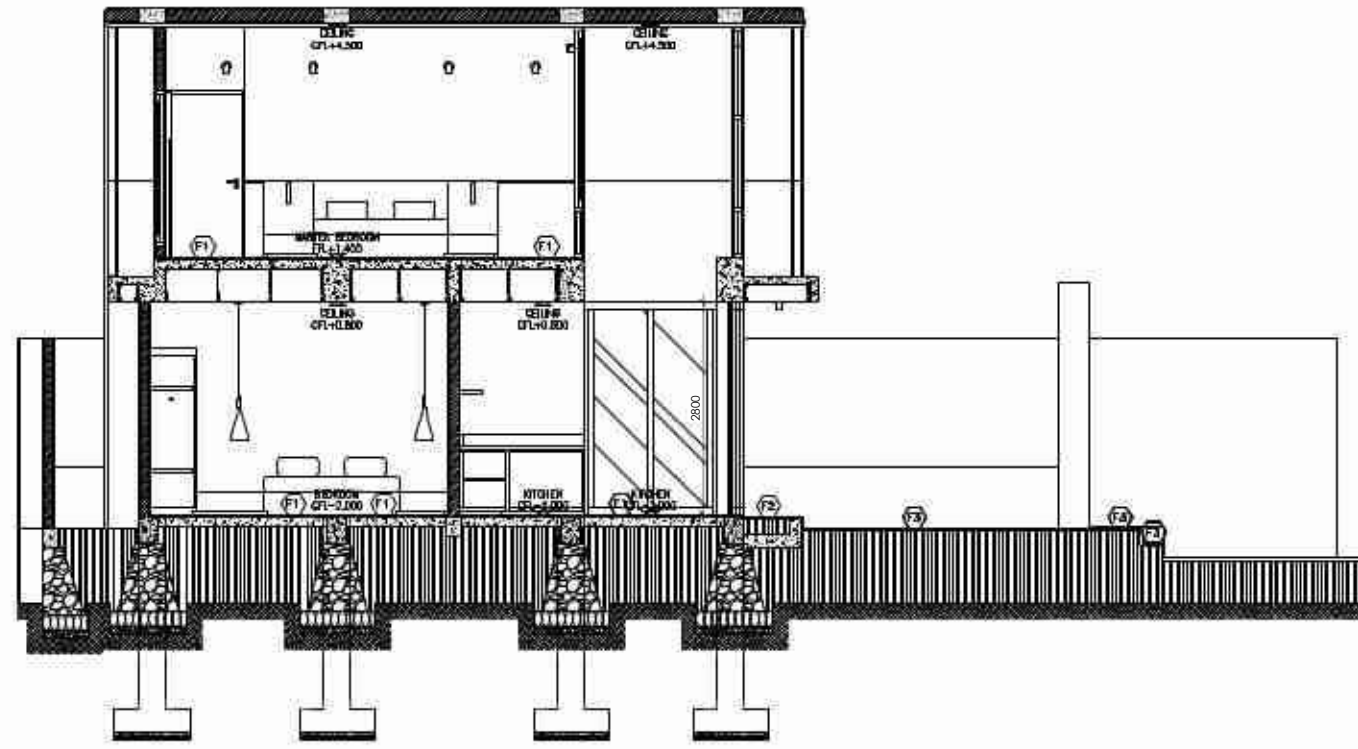
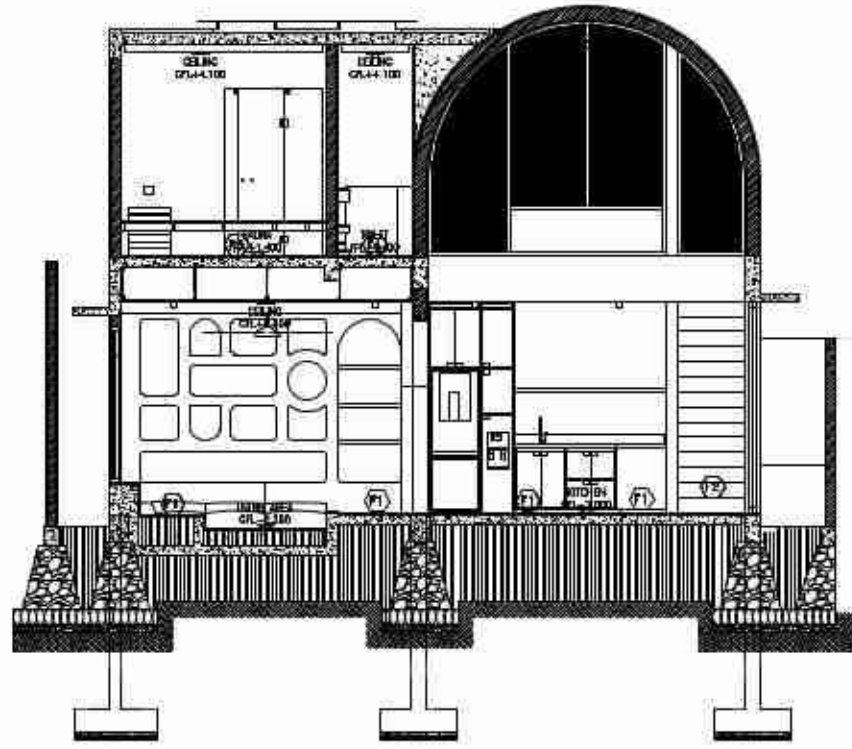

KETERANGAN	
(F1)	VICENZA STONE TILE
(F2)	SPECIAL BRICKS
(F3)	PERFIDO PAVING COBBLESTONE
(F4)	CONCRETE BARE TEXTURE GREY COLOR
(F5)	TEAK WOOD FINISH WALKWAY

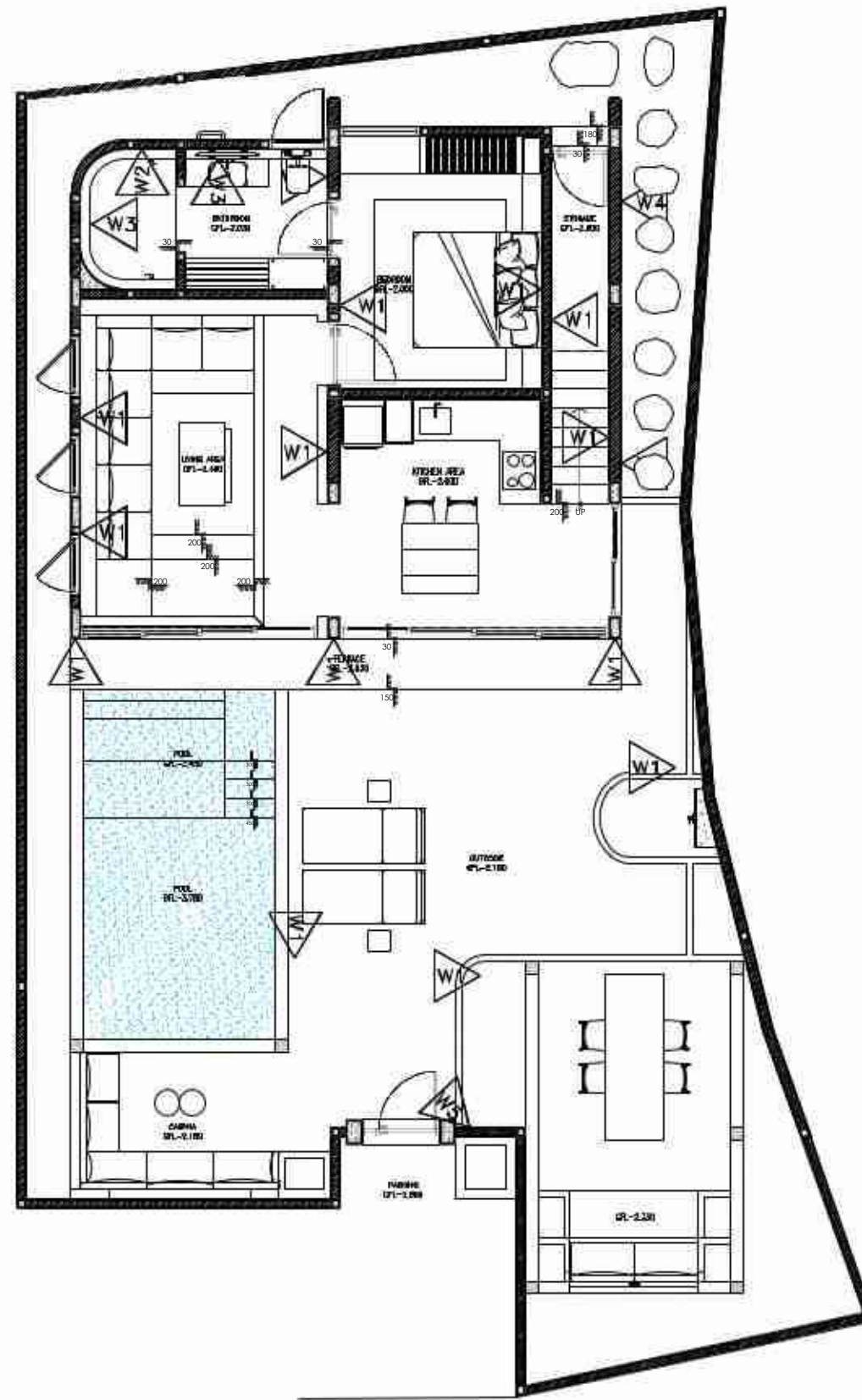

KETERANGAN	
	CONCRETE BARE TEXTURE HAZELNUT PANTONE COLOR
	MODERN AMBER TILE
	CONCRETE BARE TEXTURE GREY COLOR
	CONCRETE BARE TEXTURE PREFER TO MARBLE
	CONCRETE BARE TEXTURE PREFER TO MARBLE
	TEAK WOOD 100 MM OAK WALNUT
	SPECIAL BRICK

MATERIAL SCHEDULE WALL GROUND FLOOR VILLA A
Scale 1 : 100

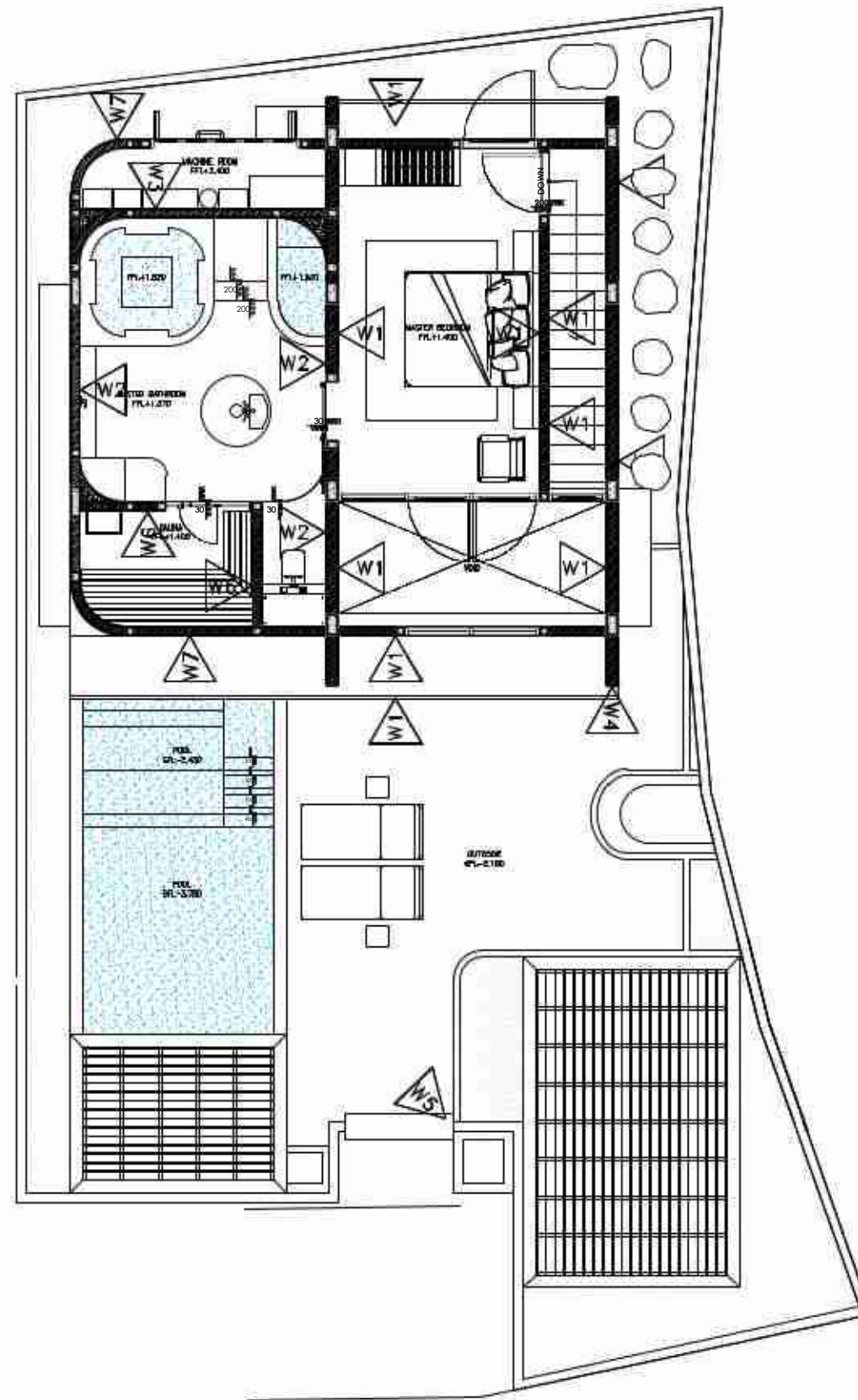

KETERANGAN	
	CONCRETE BARE TEXTURE HAZELNUT PANTONE COLOR
	MOSAIK MARBEL TILE
	CONCRETE BARE TEXTURE GREY COLOR
	CONCRETE BARE TEXTURE PREFER TO MAKE
	CONCRETE BARE TEXTURE PREFER TO MAKE
	TEAK WOOD FIN ORAK WALNUT
	SPECIAL FINISH

MATERIAL SCHEDULE WALL FIRST FLOOR VILLA A
Scale 1 : 100

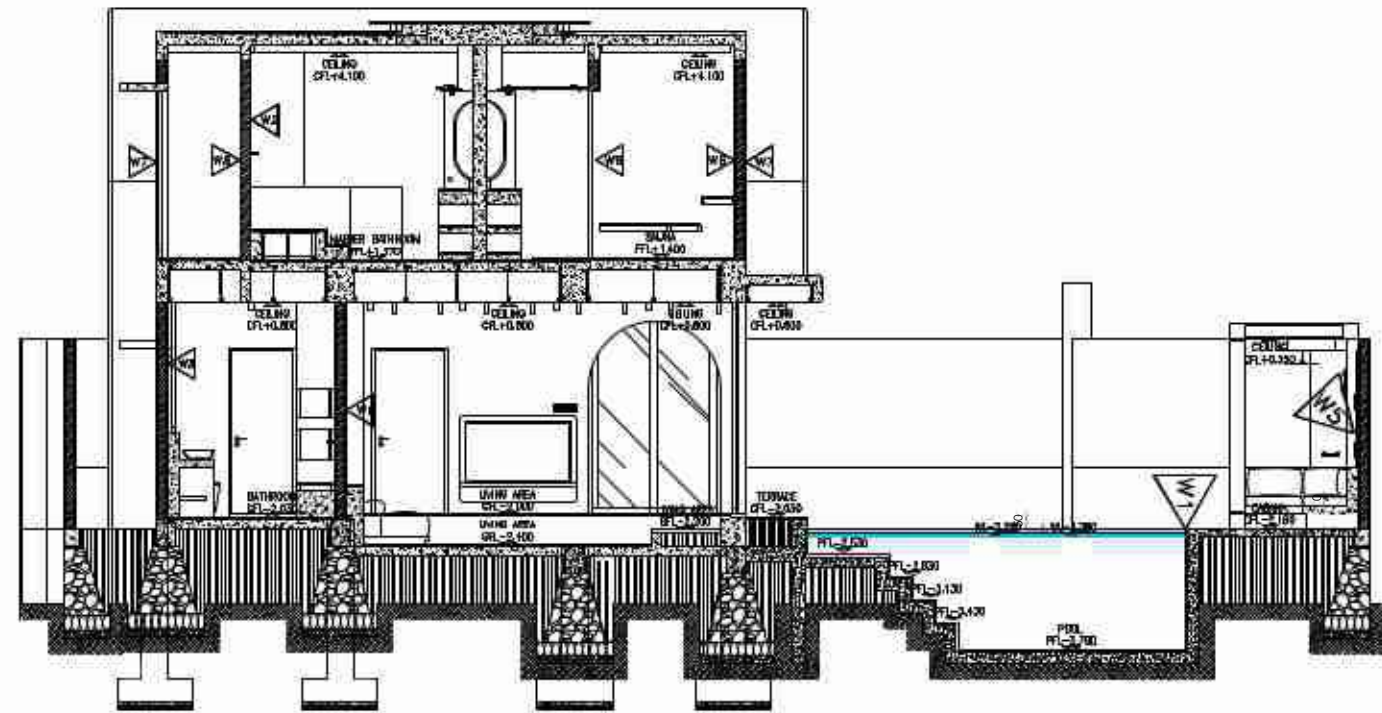
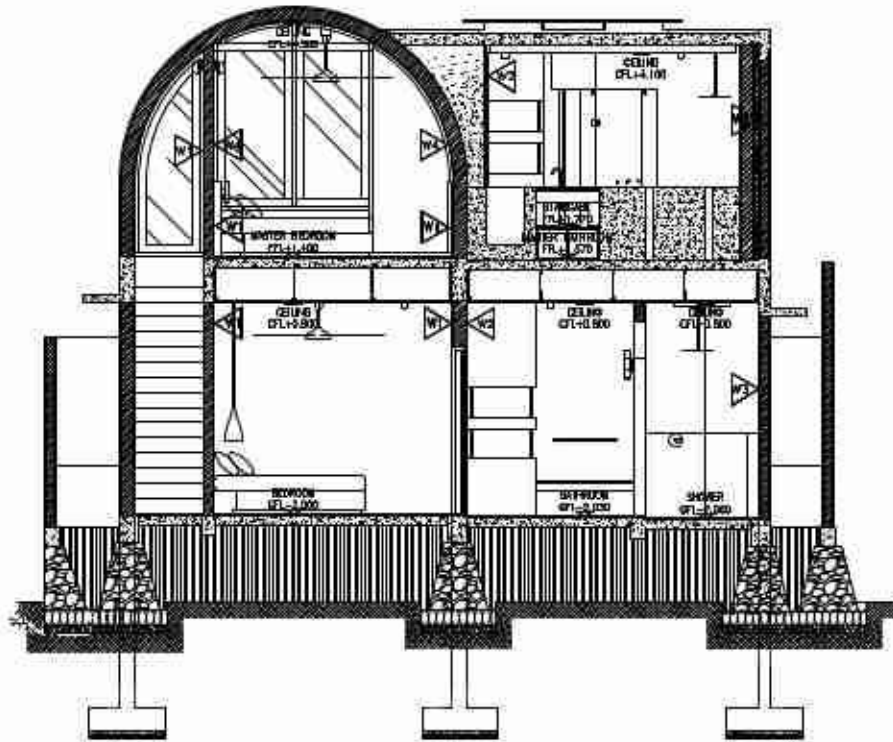
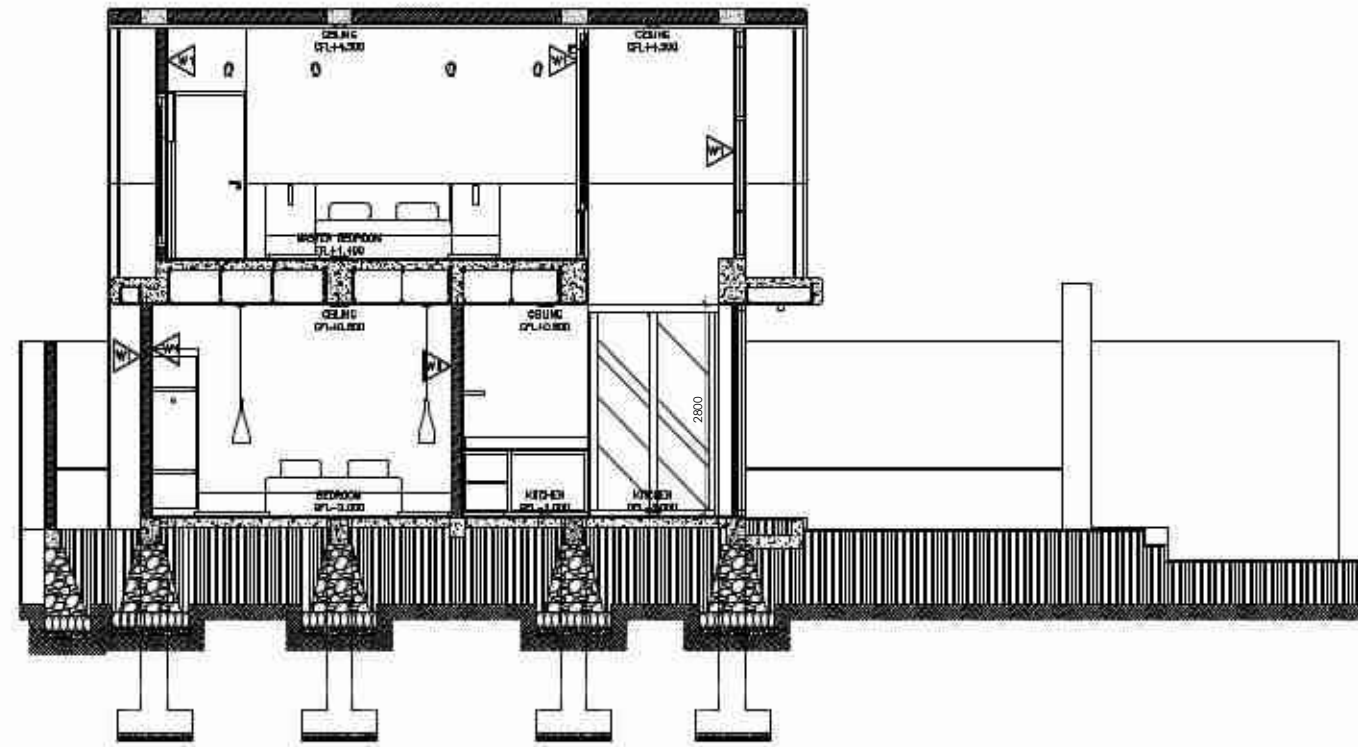
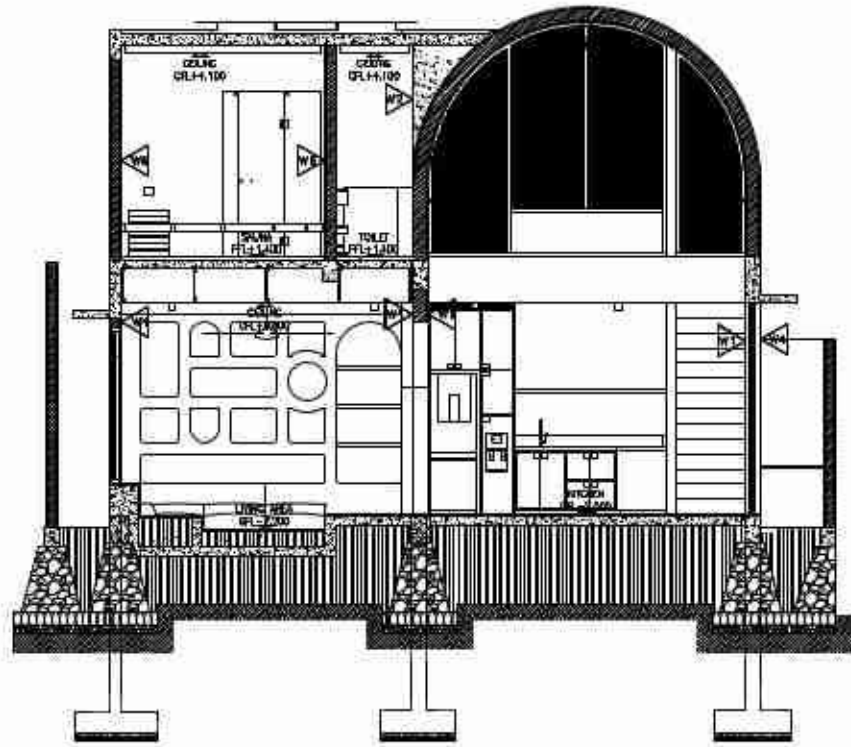

KETERANGAN	
	CONCRETE BASE TEXTURE HAZELNUT PARTITION COLOR
	MOSAIC MARBLE TILE
	CONCRETE BASE TEXTURE GREY COLOR
	CONCRETE BASE TEXTURE PREFER TO IMAGE
	CONCRETE BASE TEXTURE PREFER TO IMAGE
	TEAK WOOD PIN DARK NUHANT
	SPECIAL BRICKS

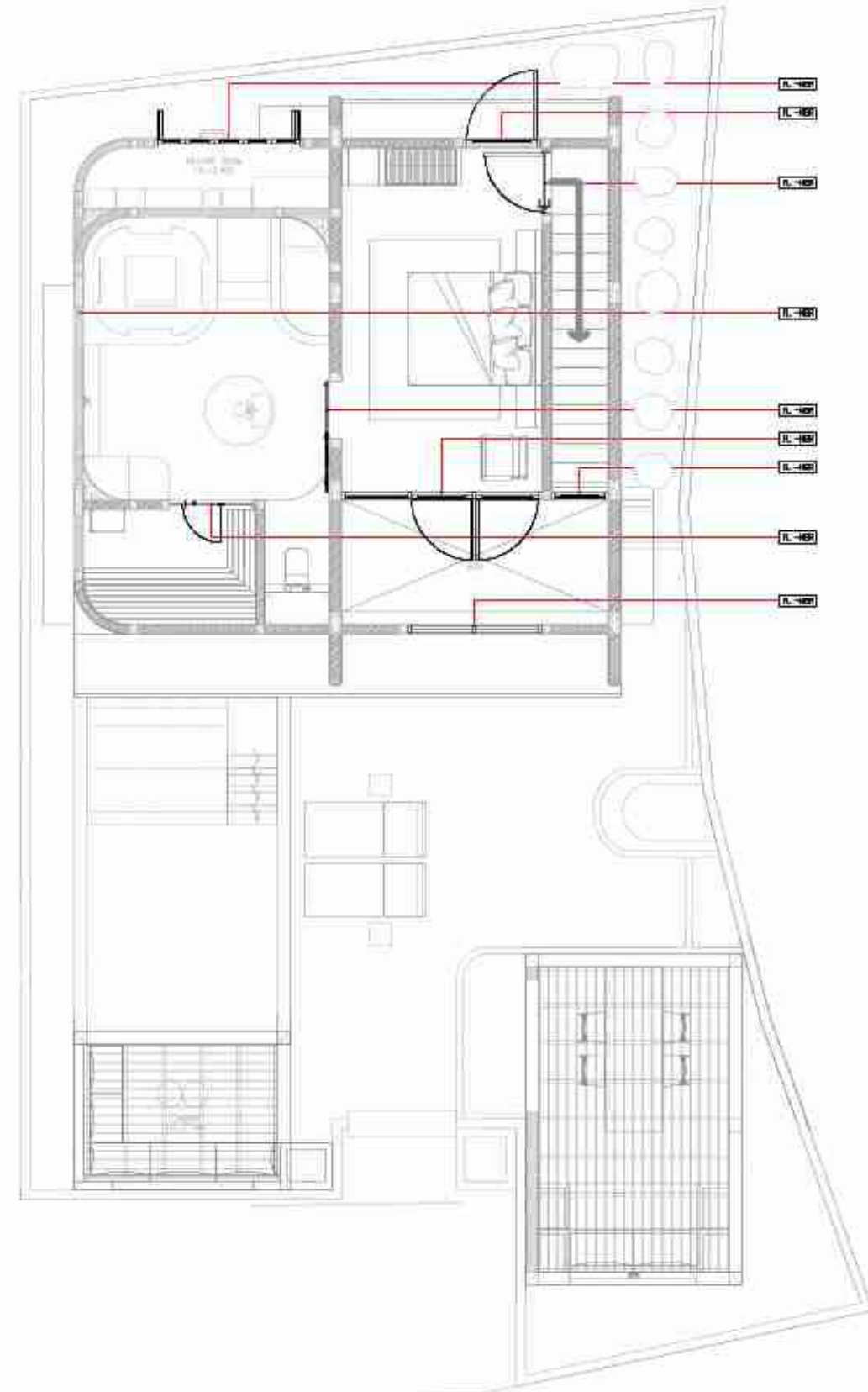
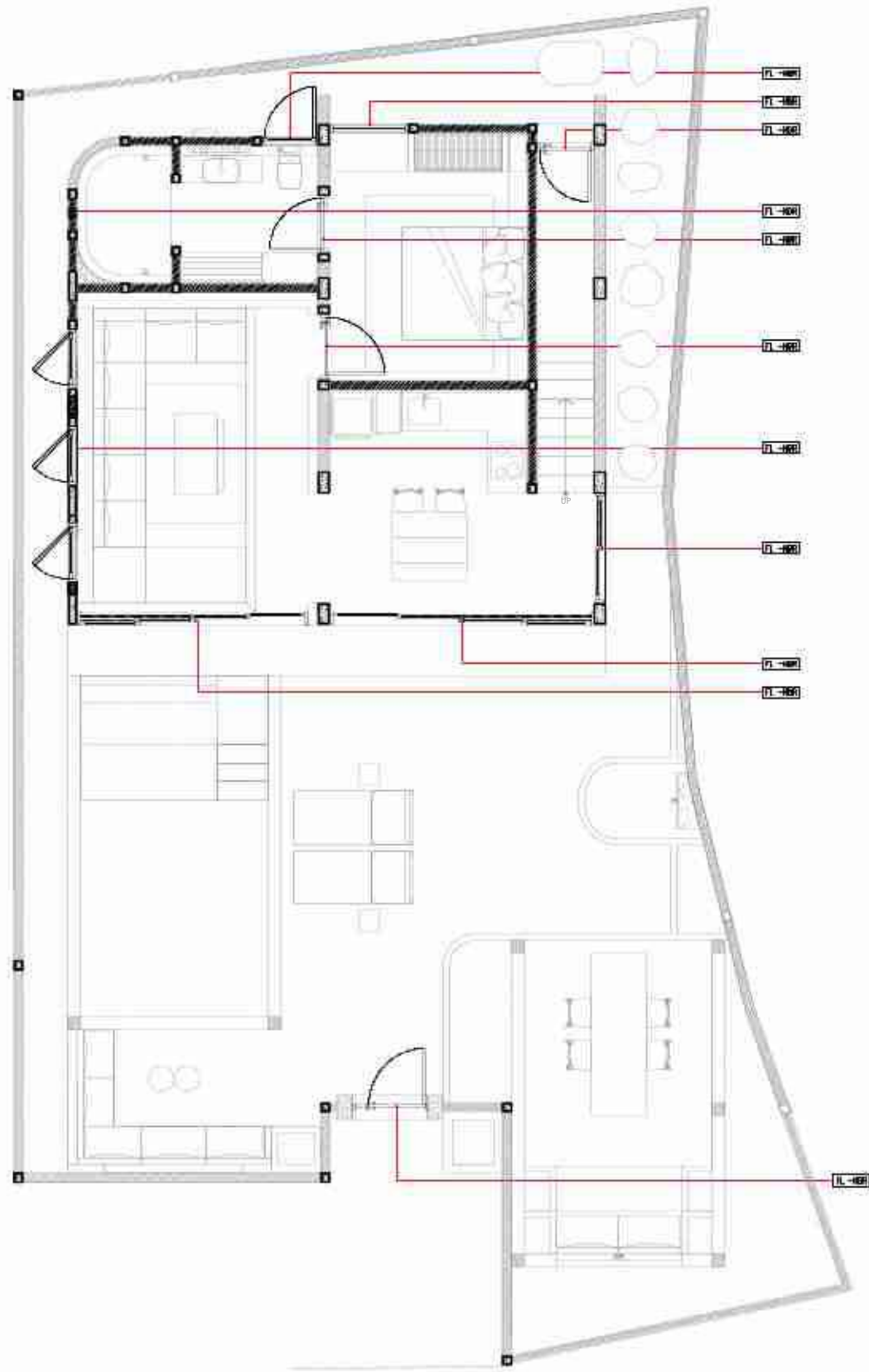

DOOR AND WINDOW PLAN VILLA A
Scale 1 : 100

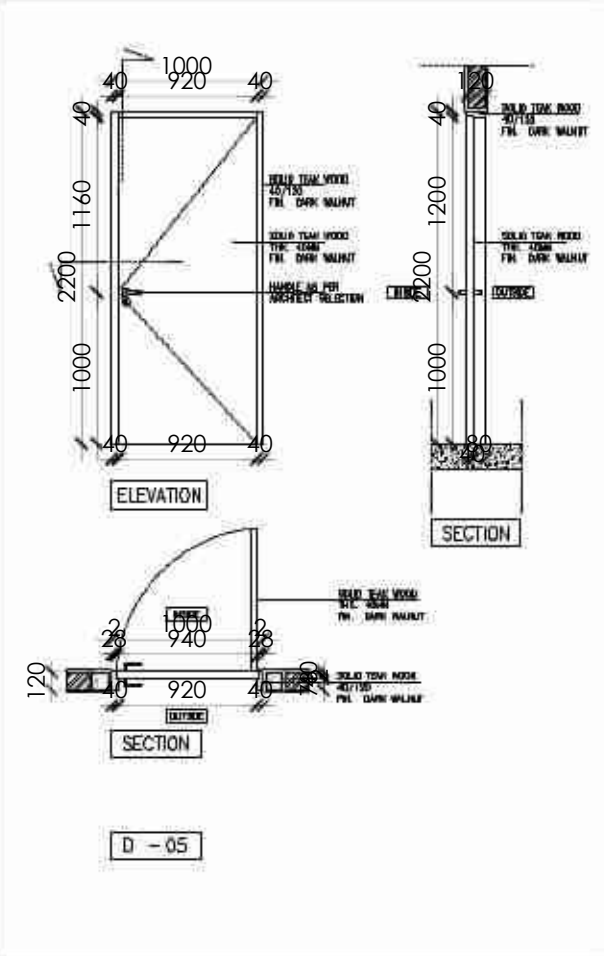
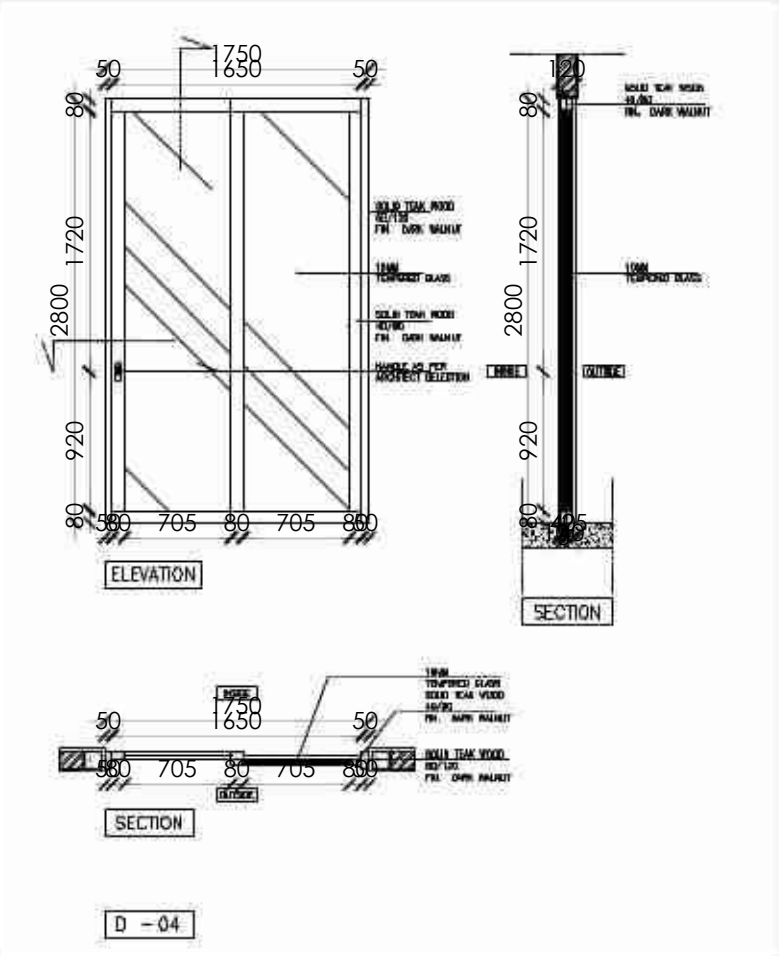
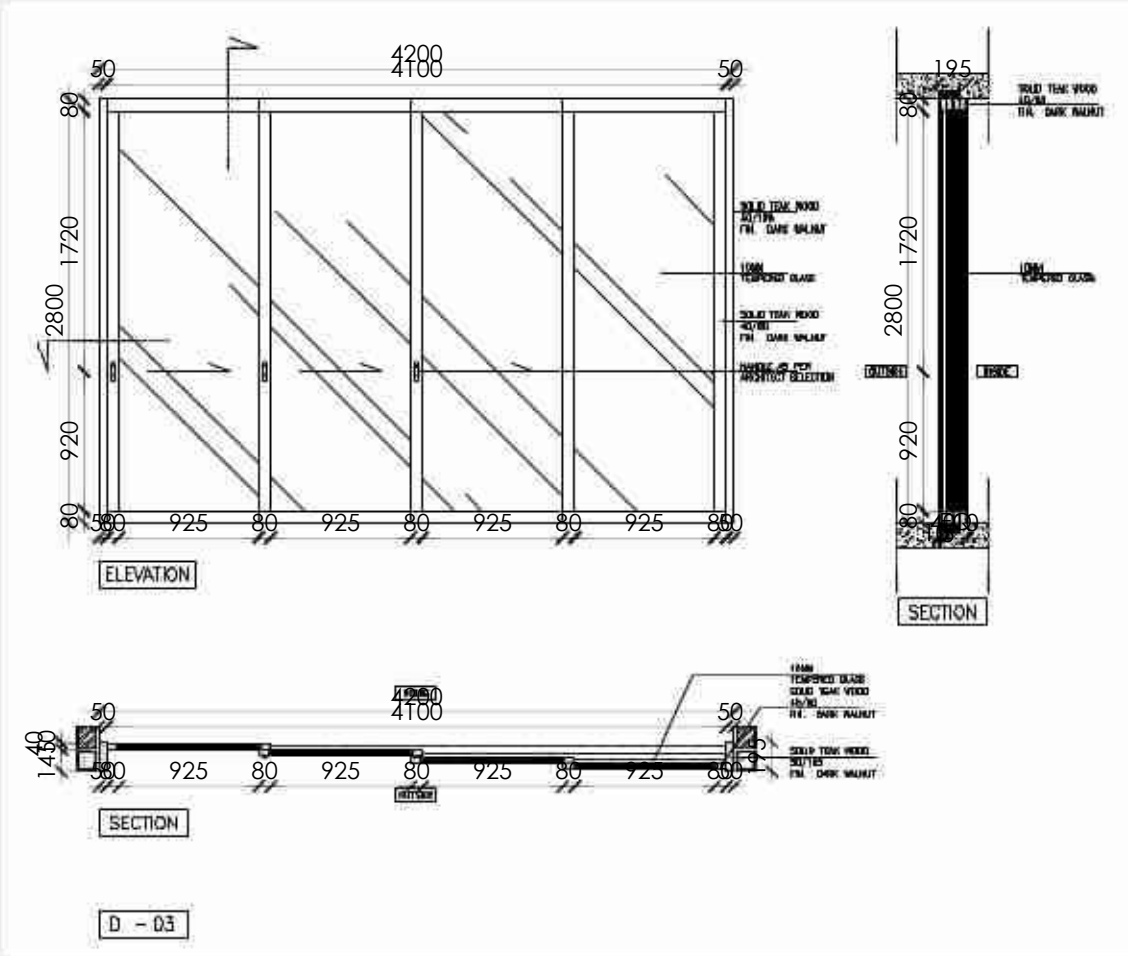
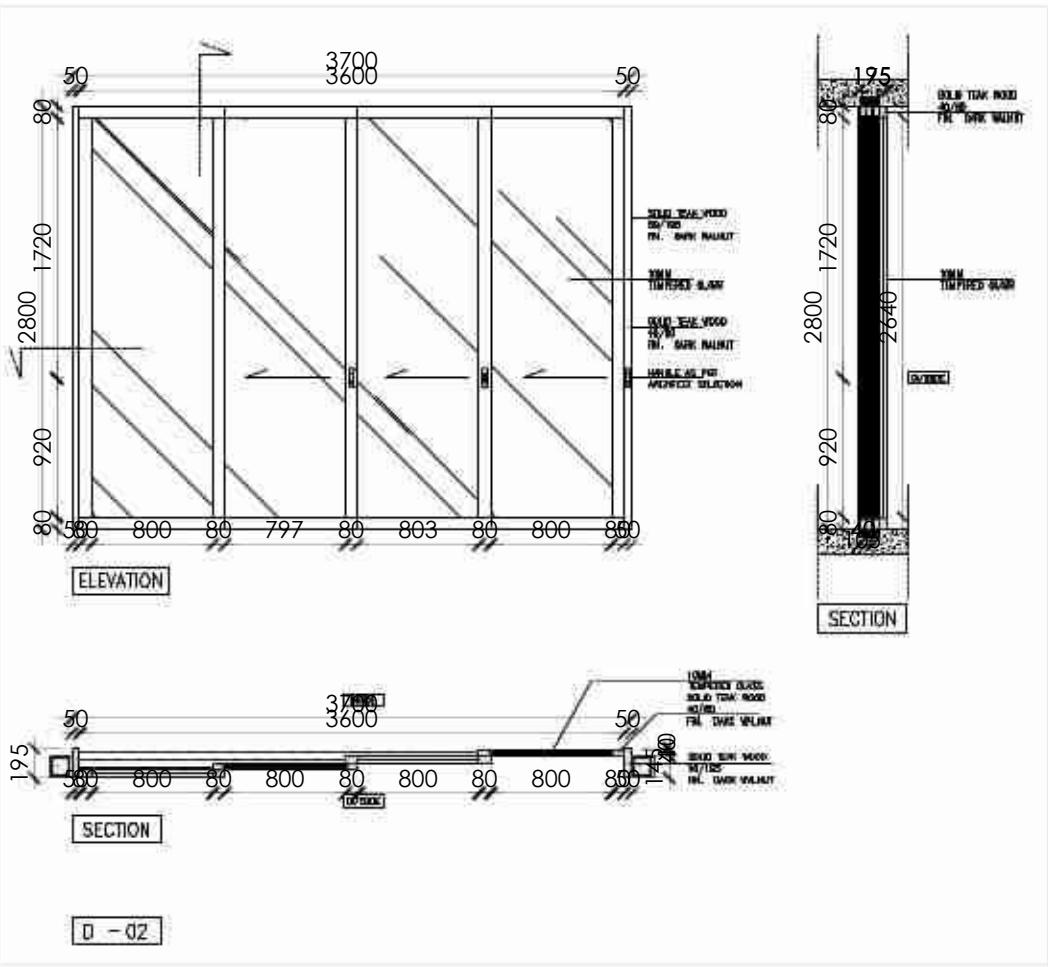
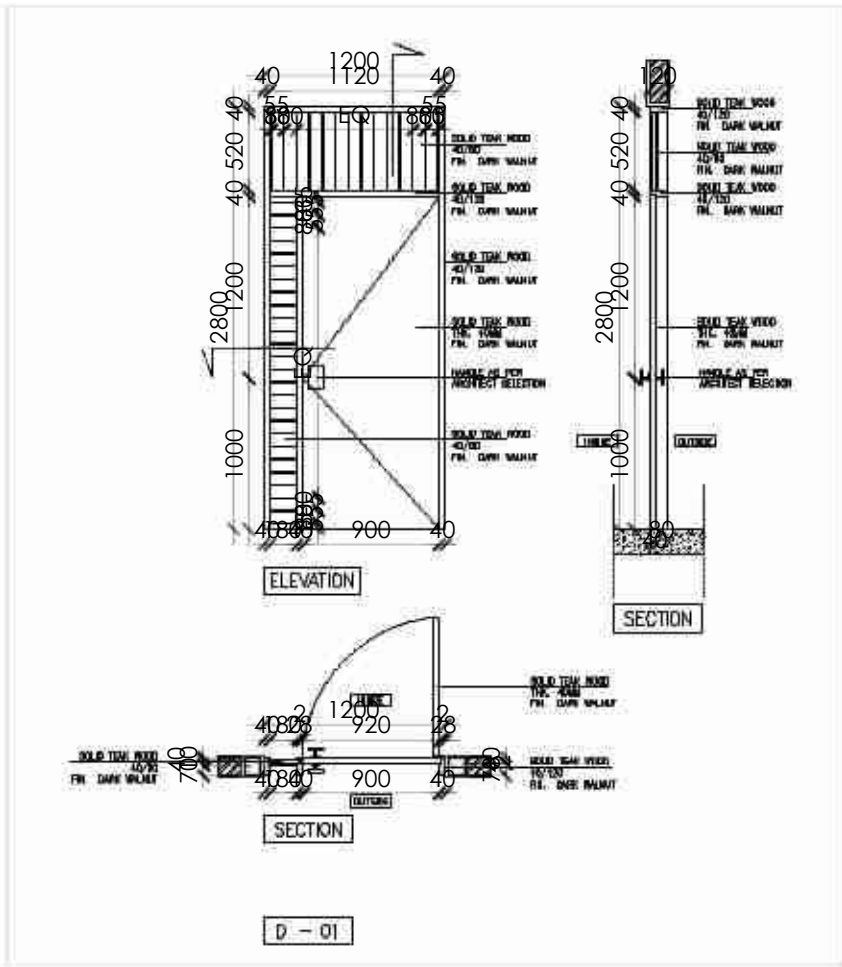

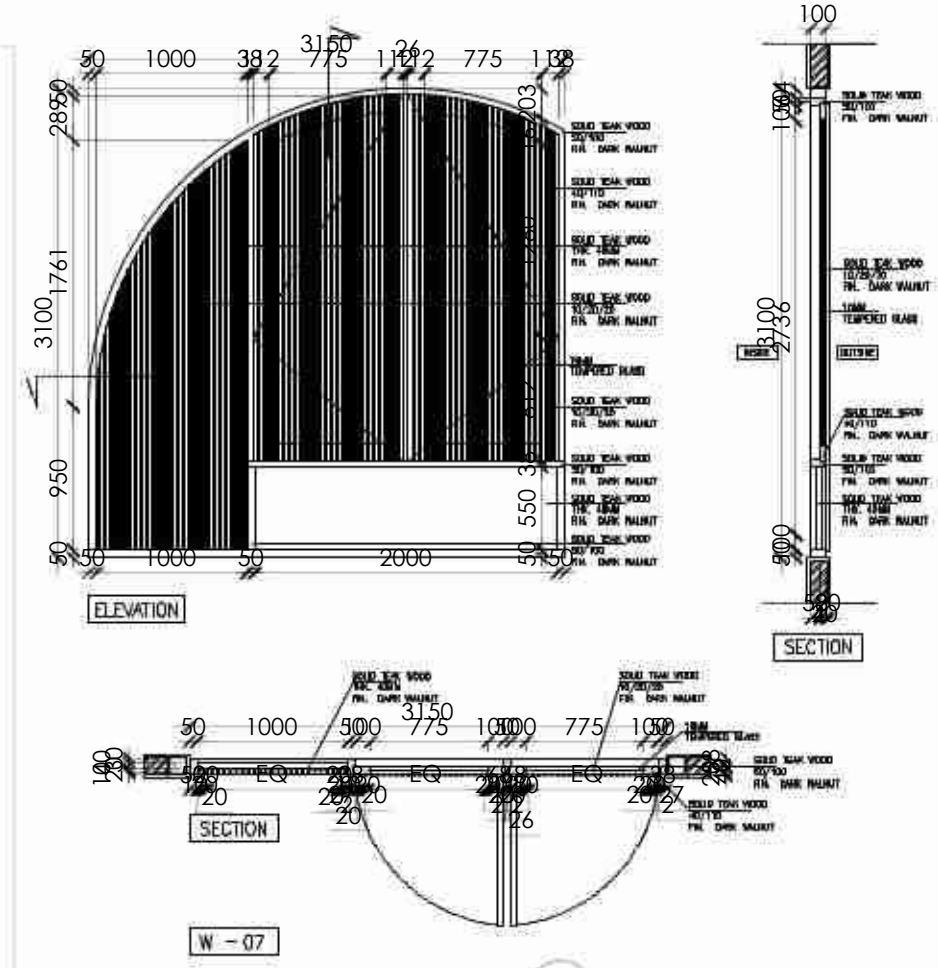
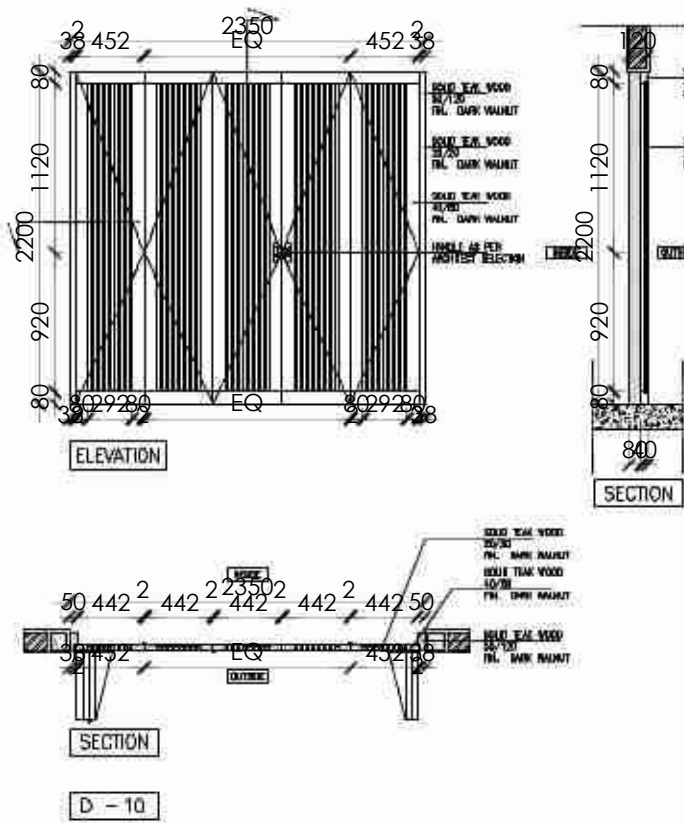
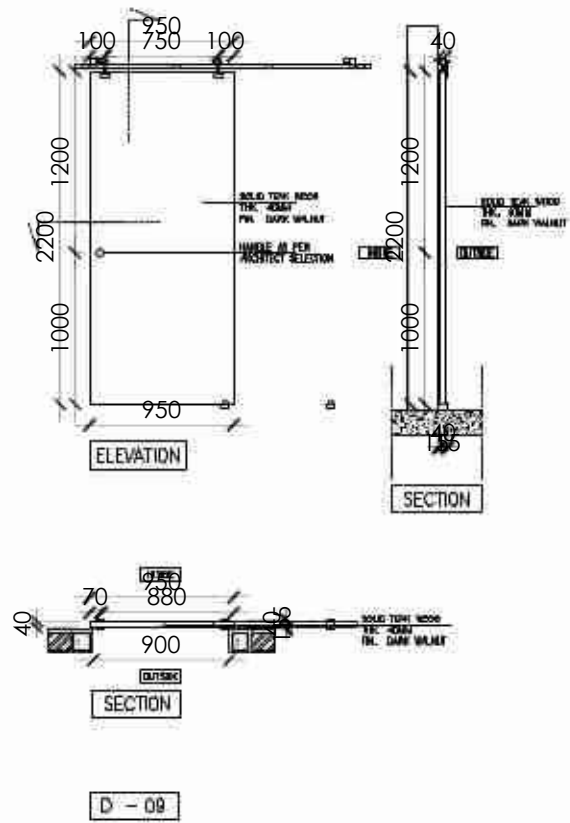
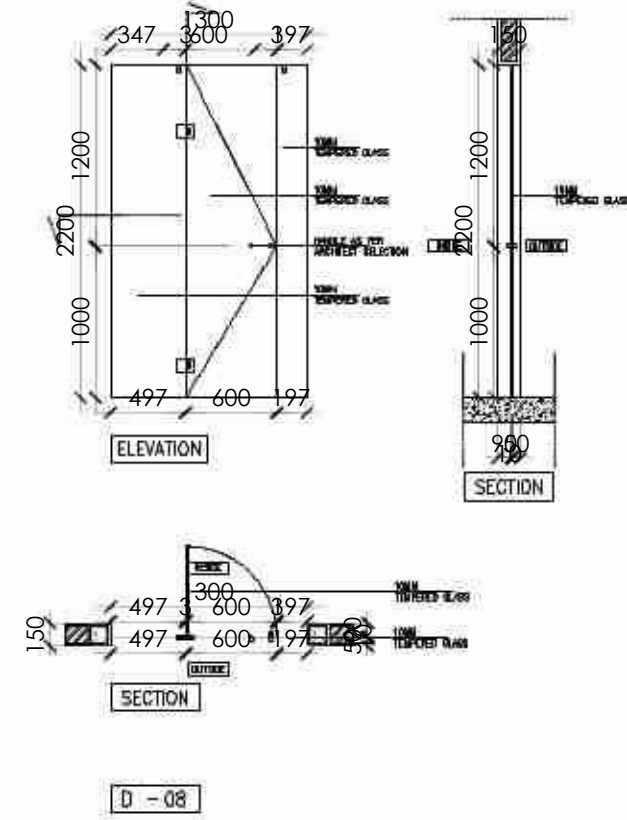
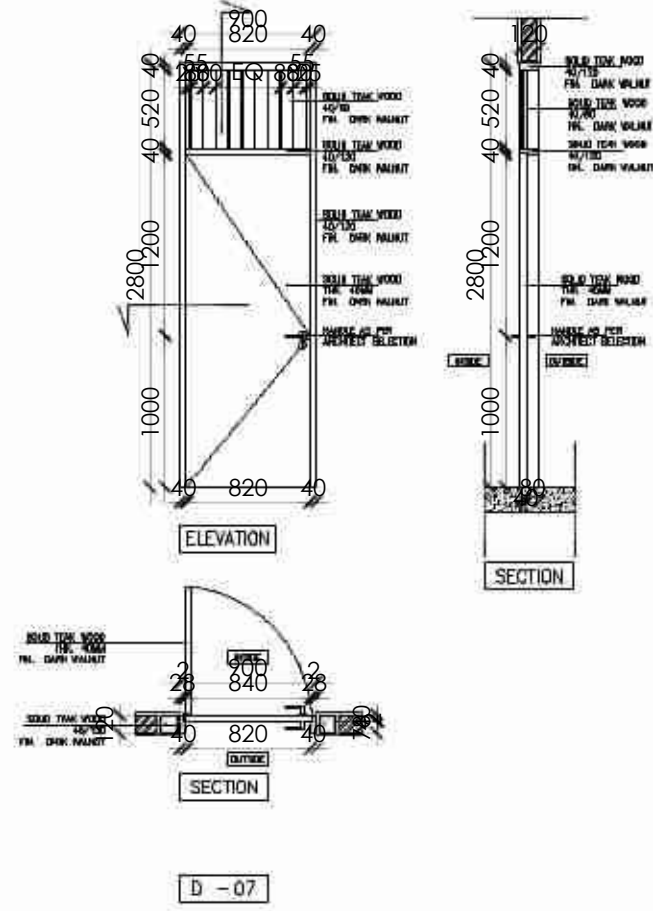
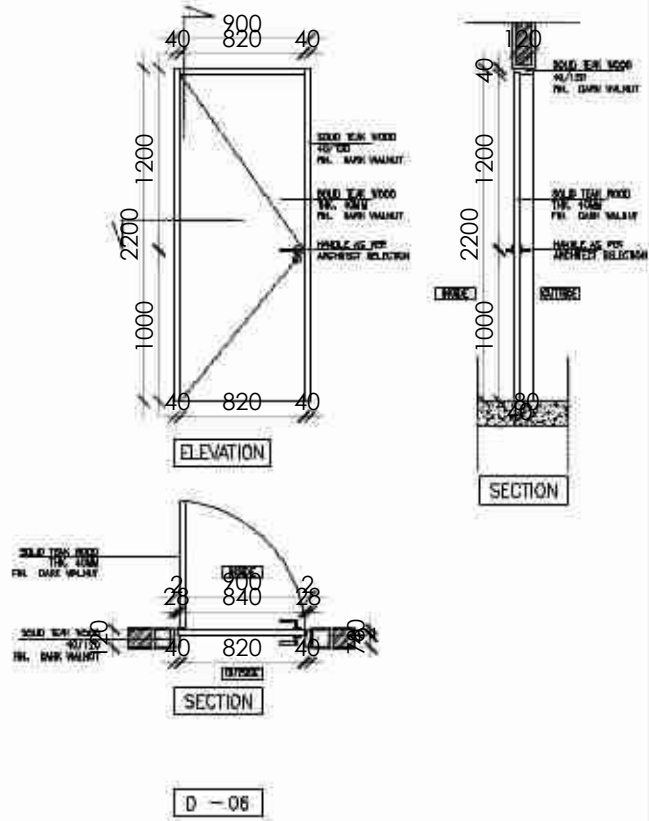

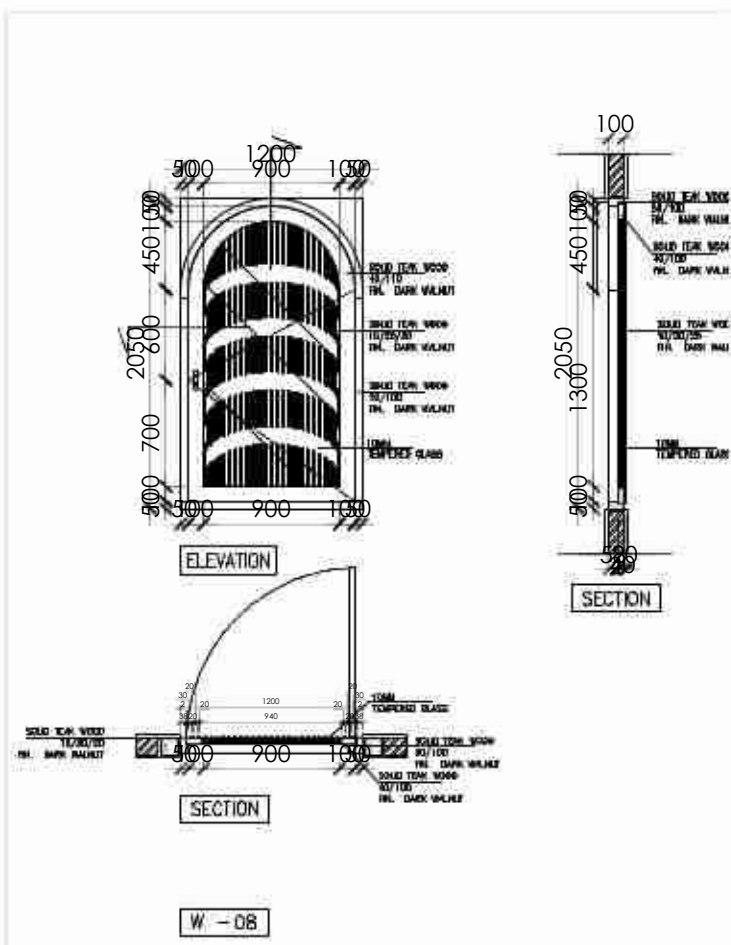
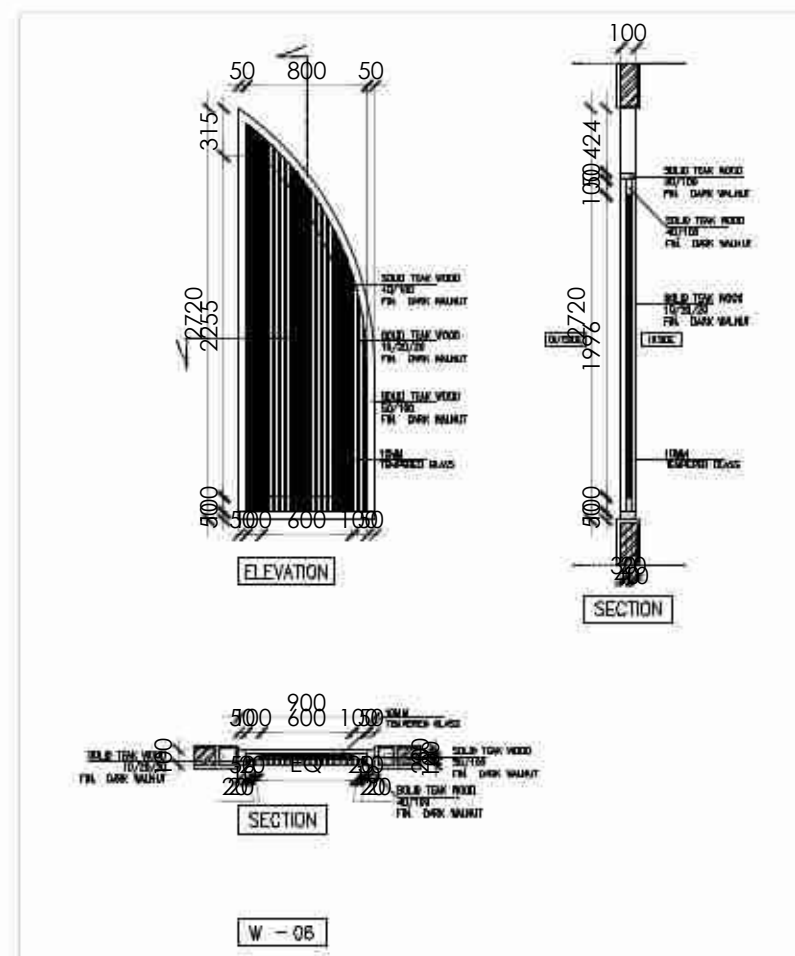
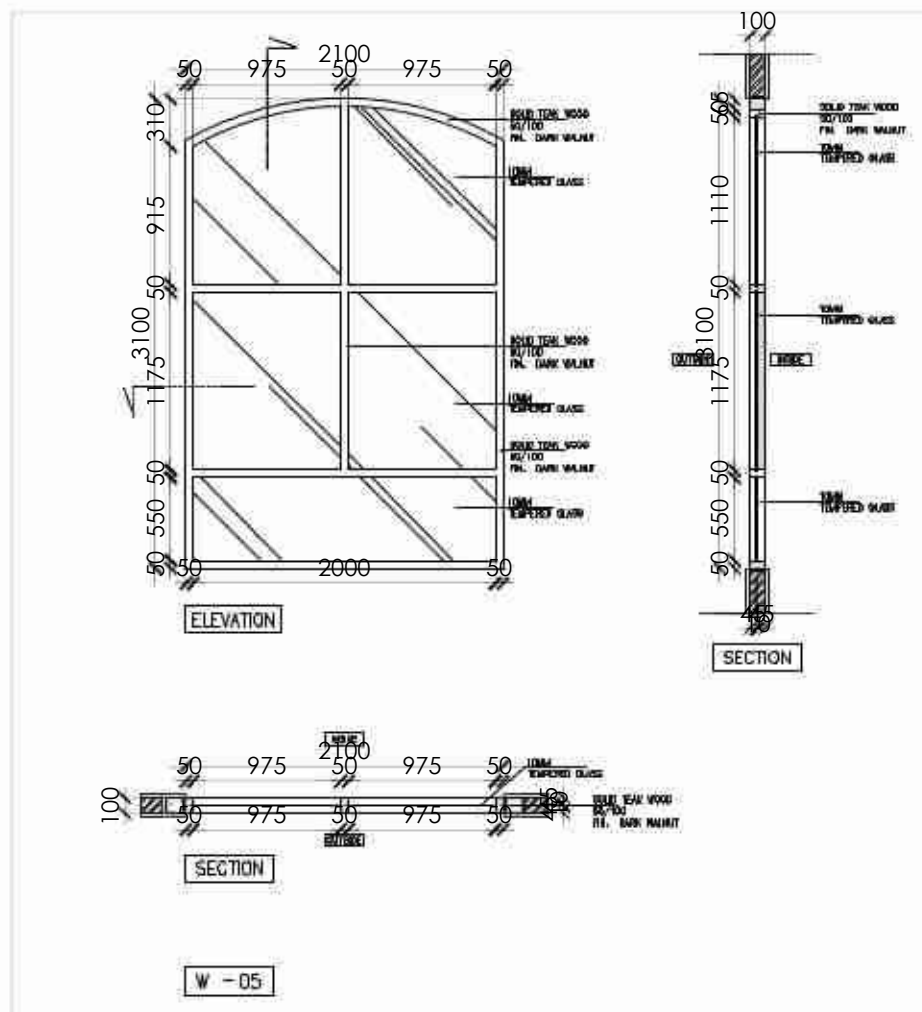
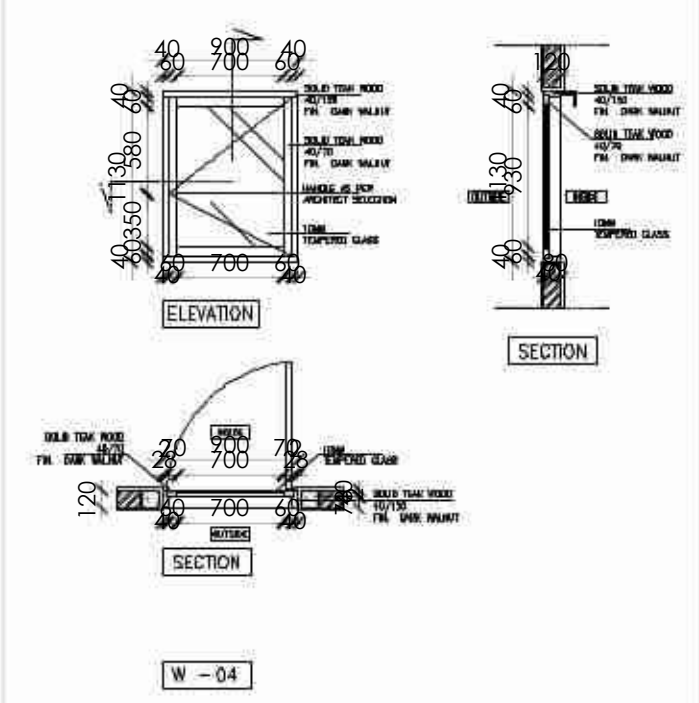
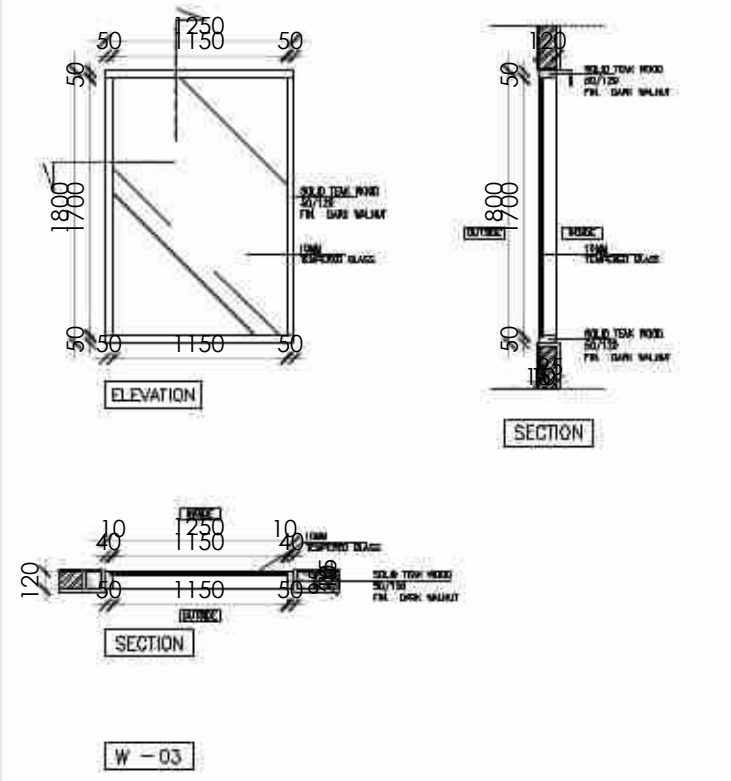
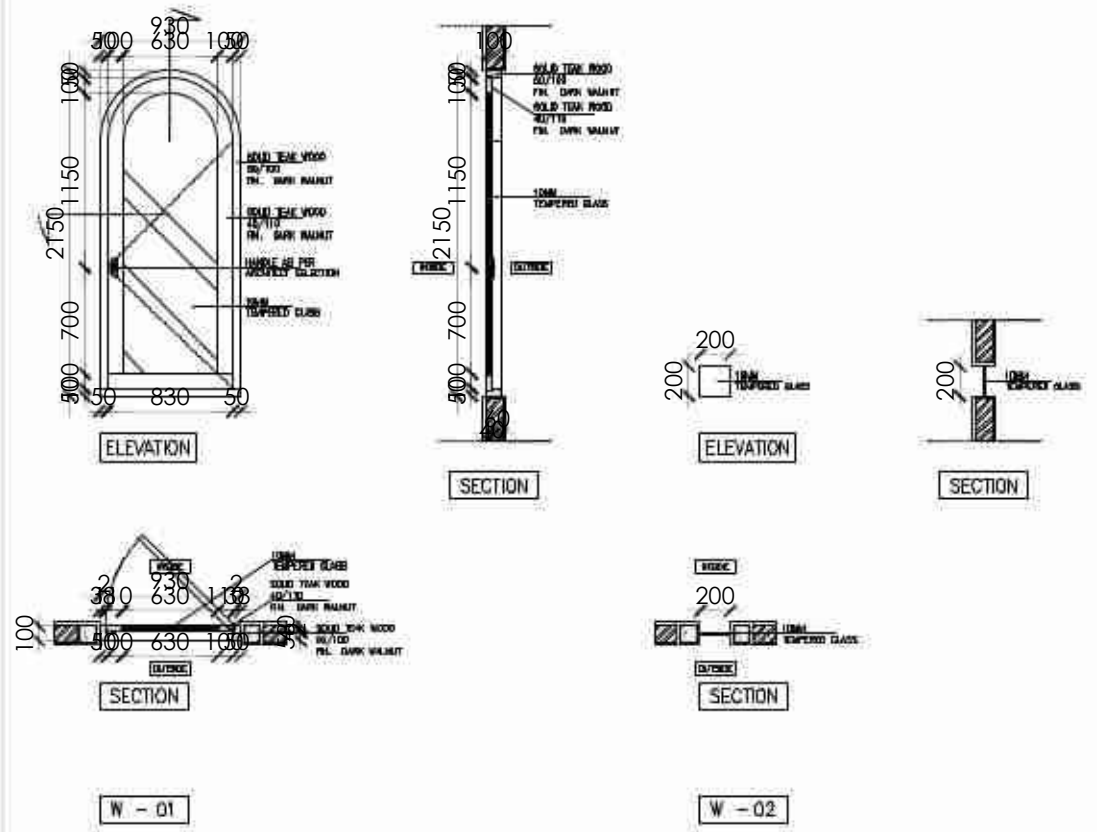

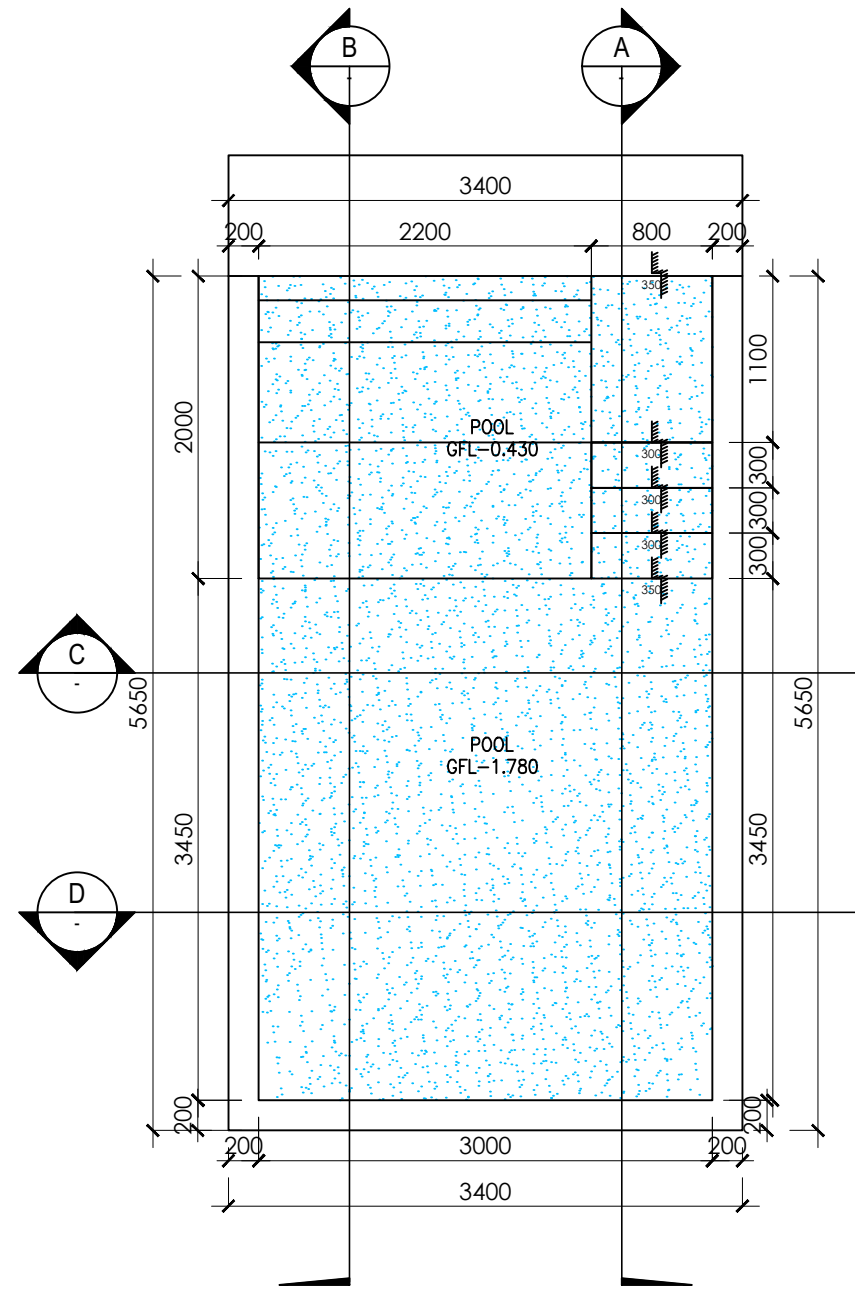

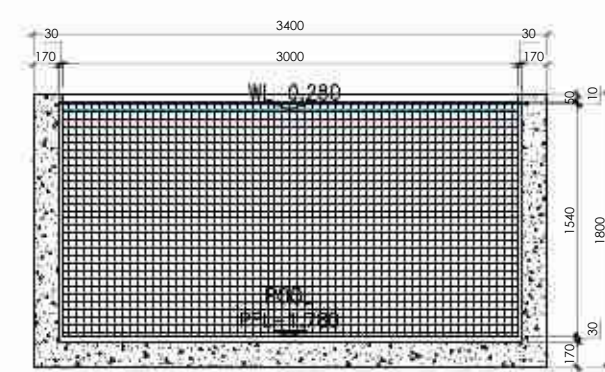
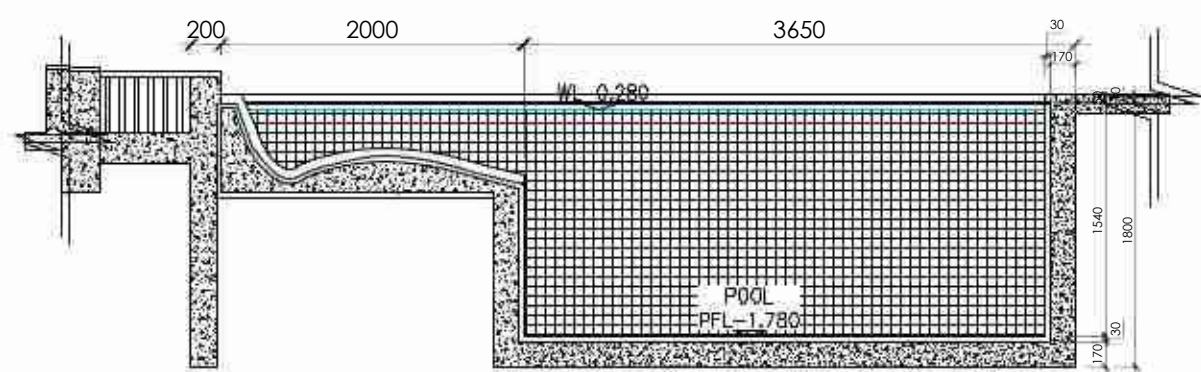
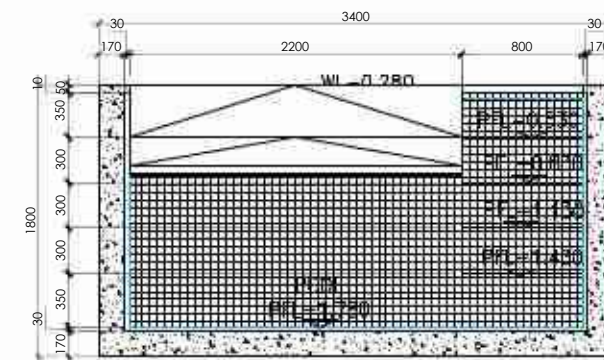

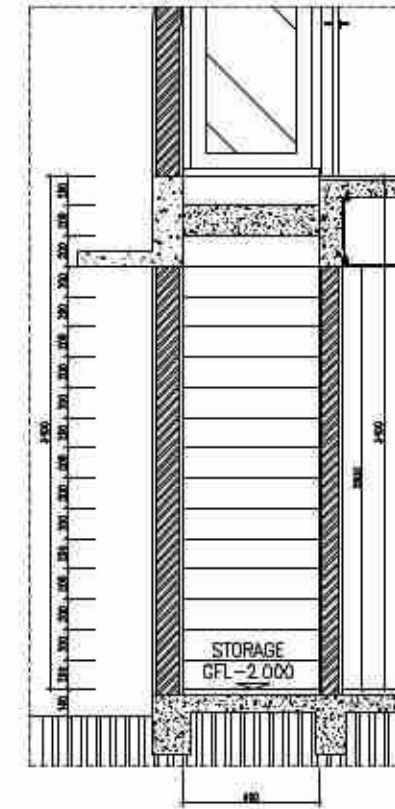
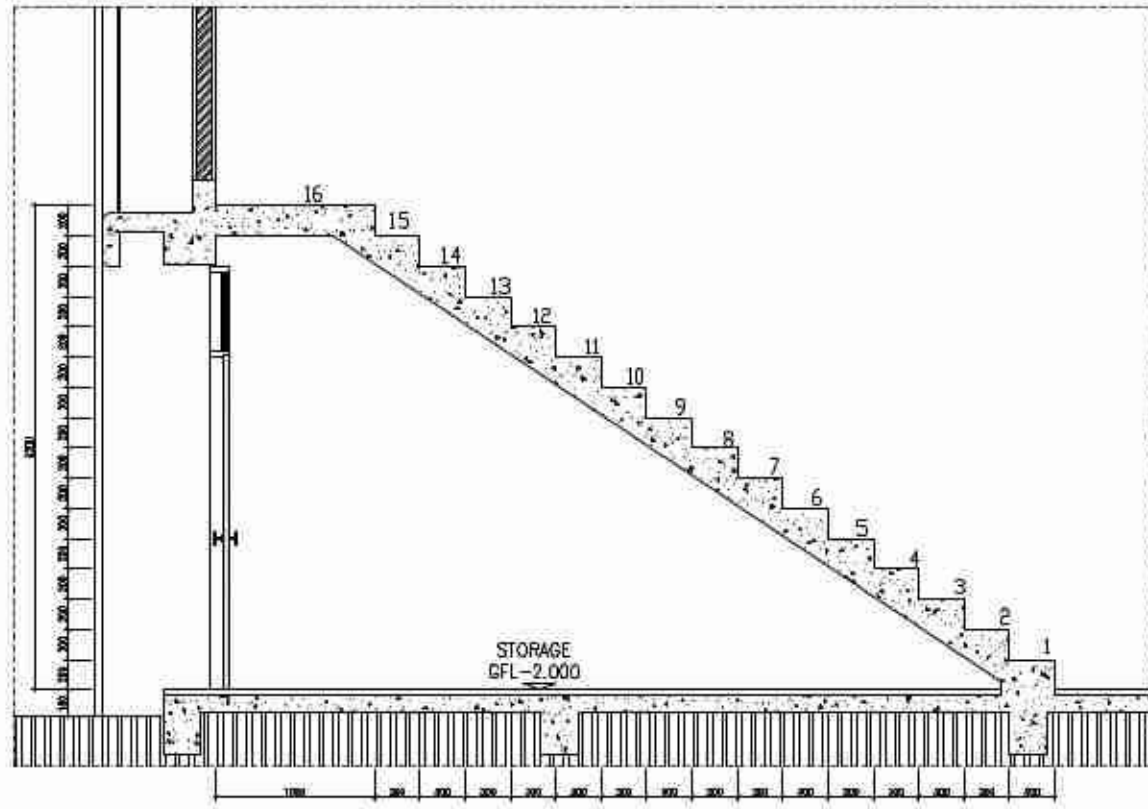
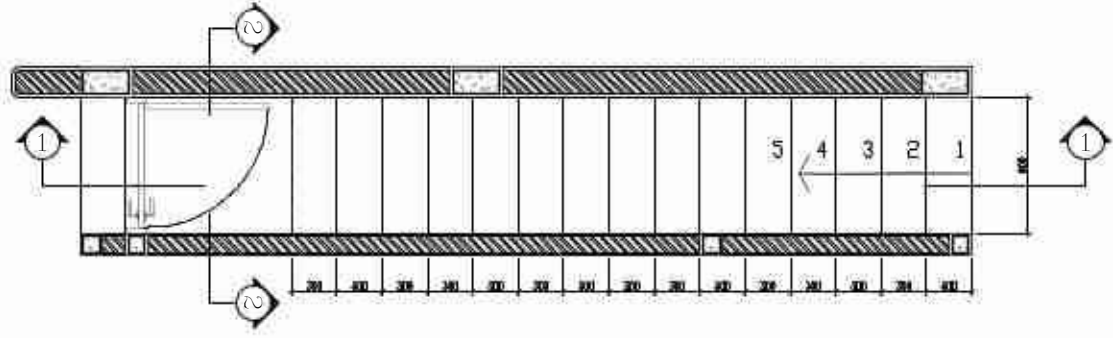
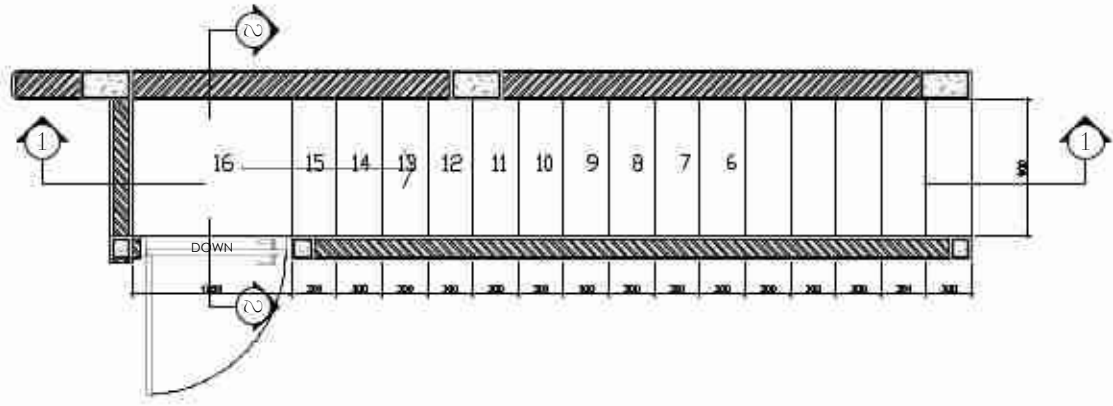

STAIR PLAN, SECTION AND DETAIL VILLA A
Scale 1 : 50

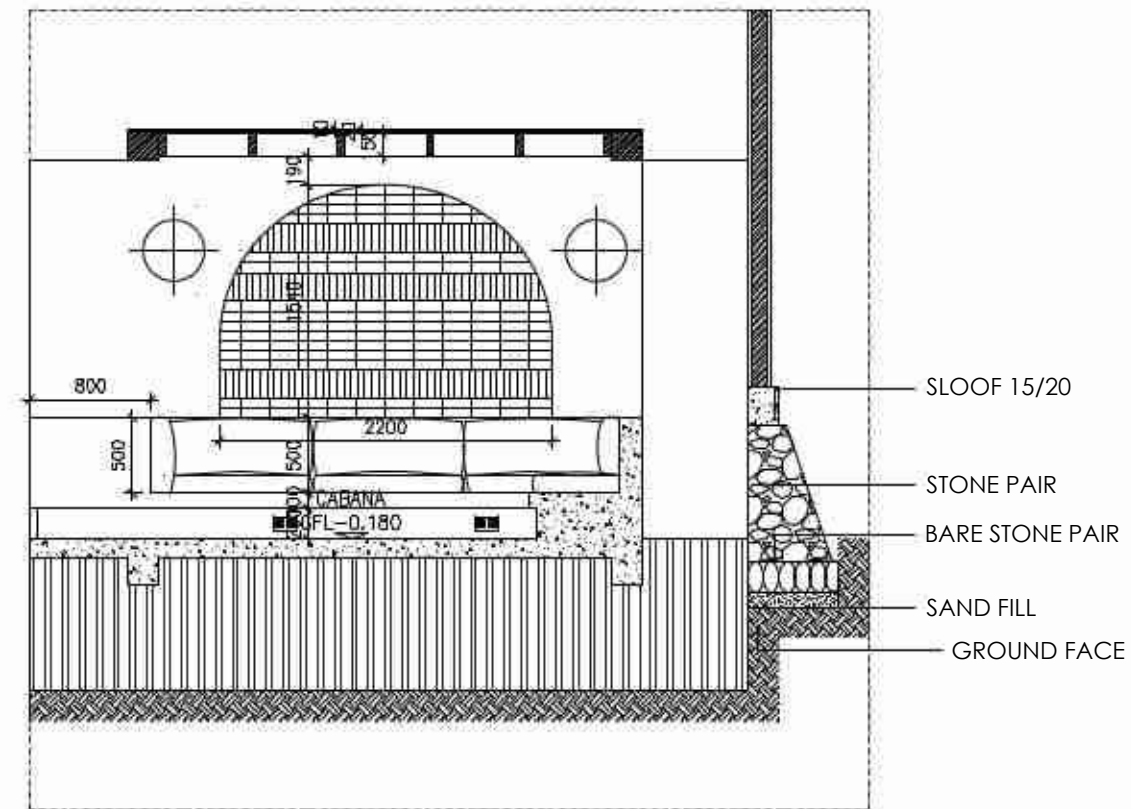
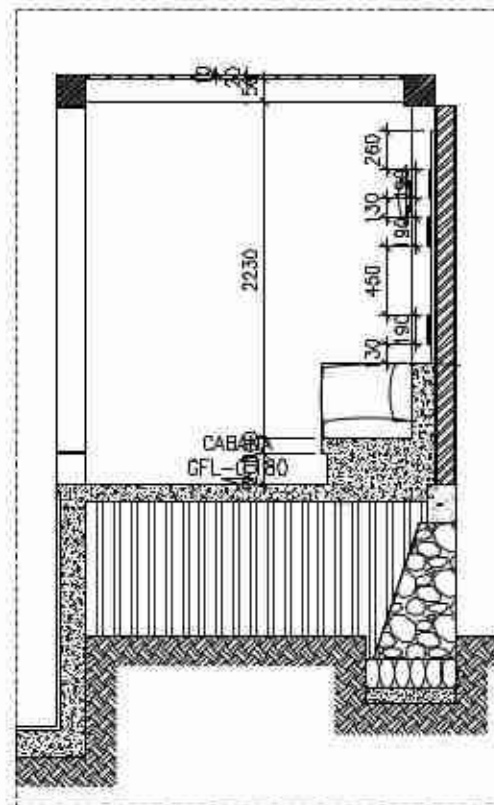
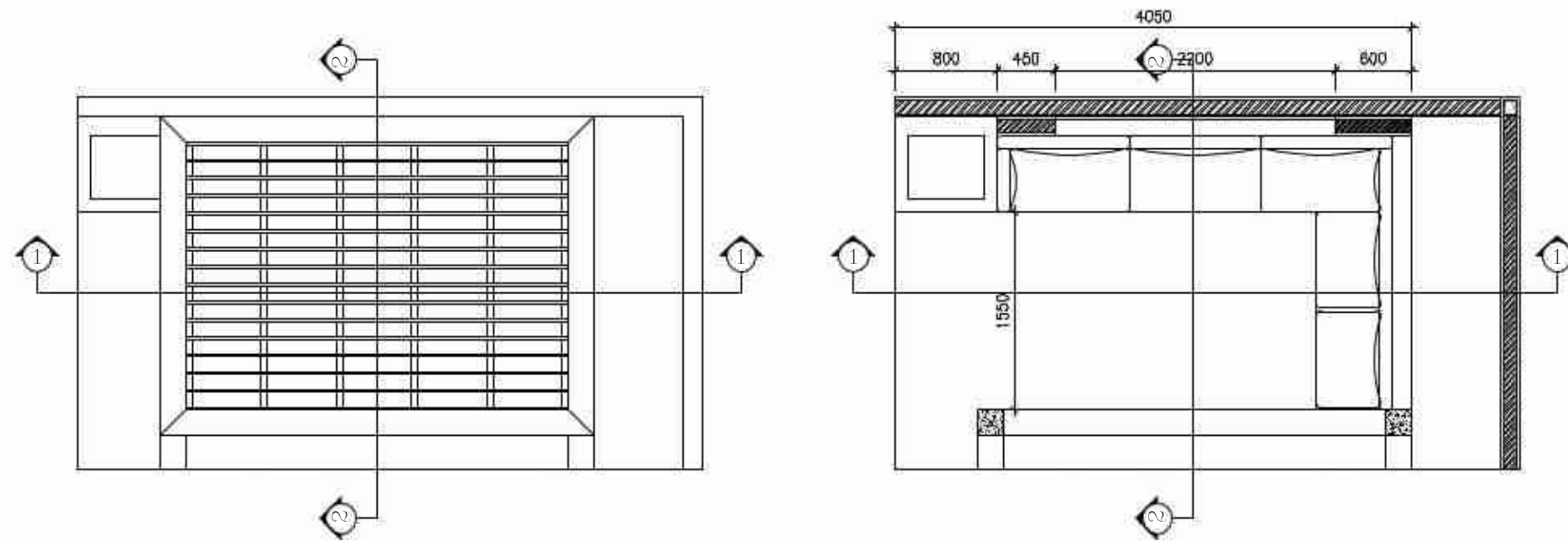

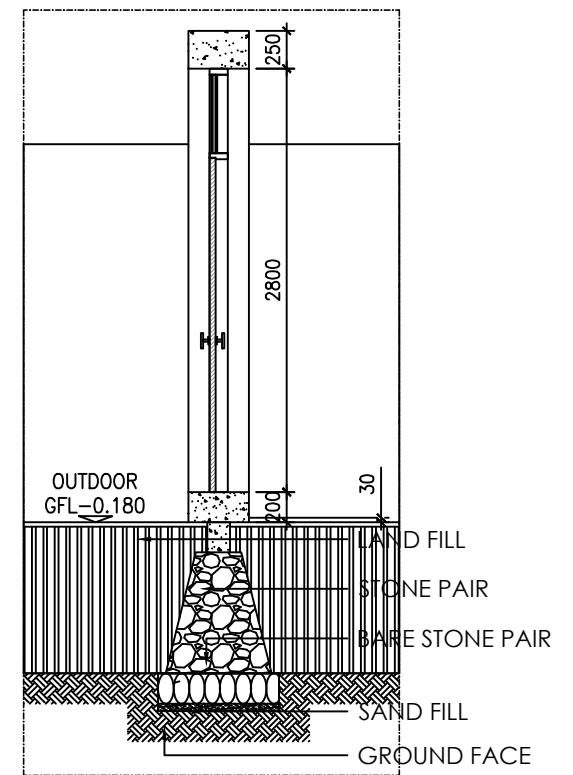
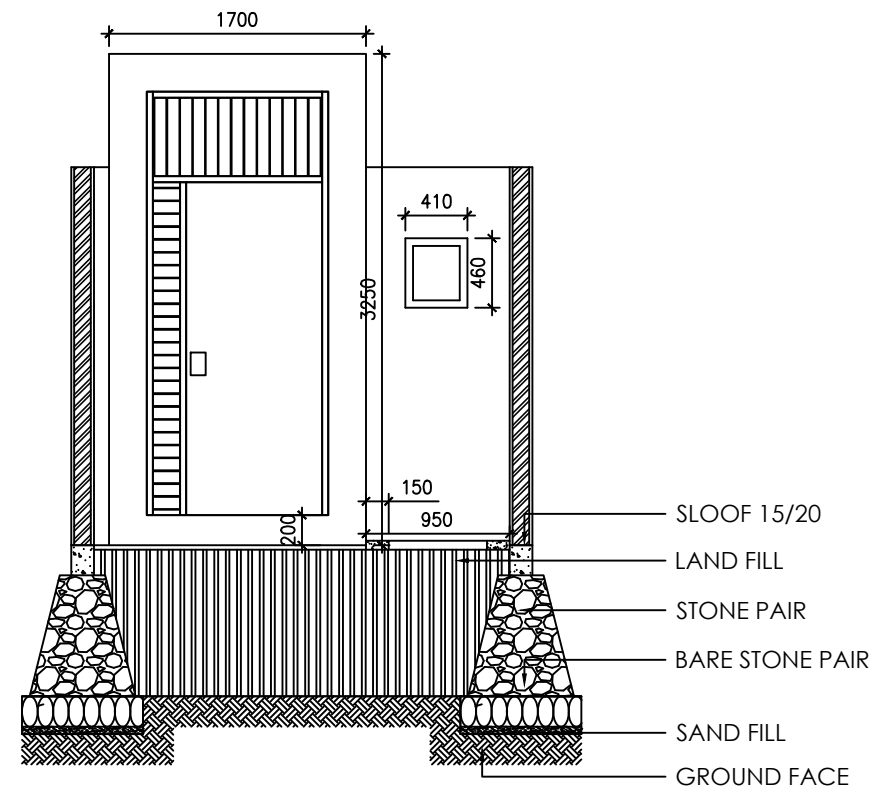
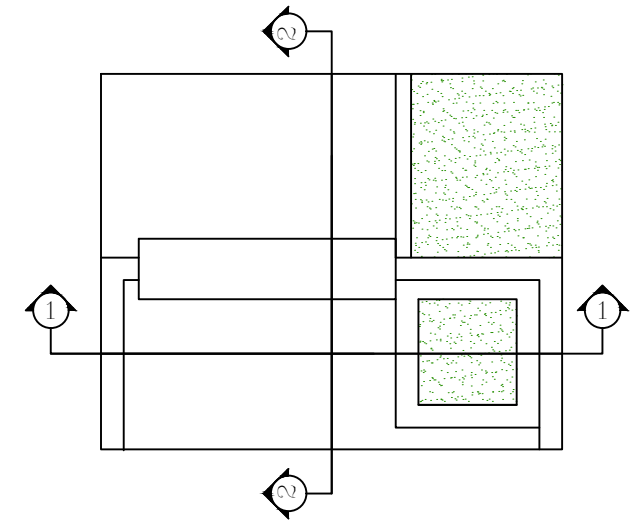
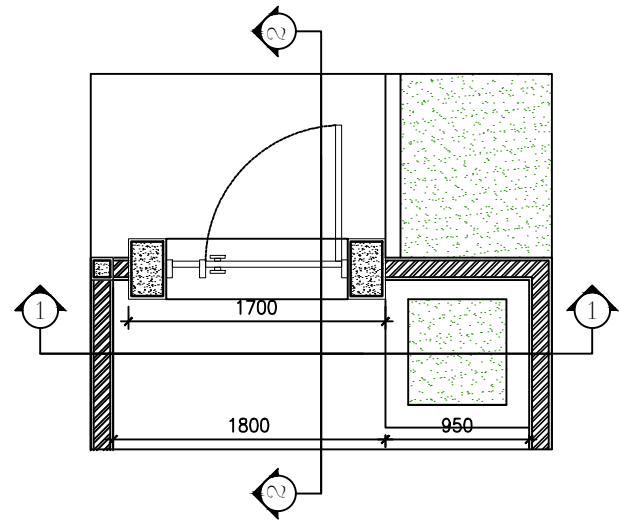

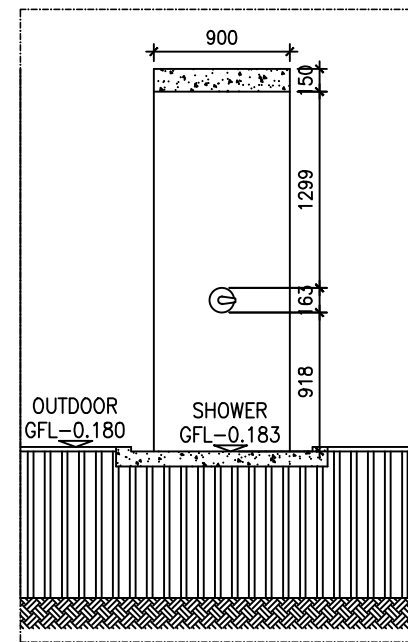
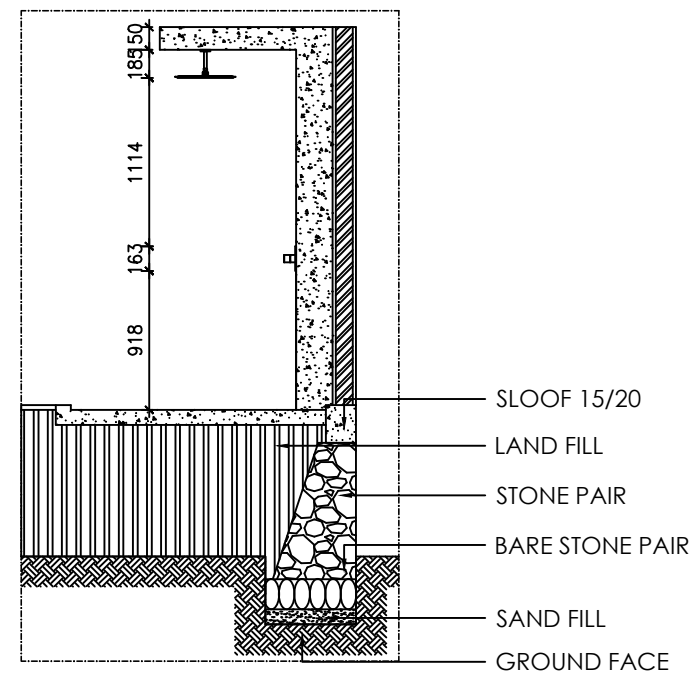
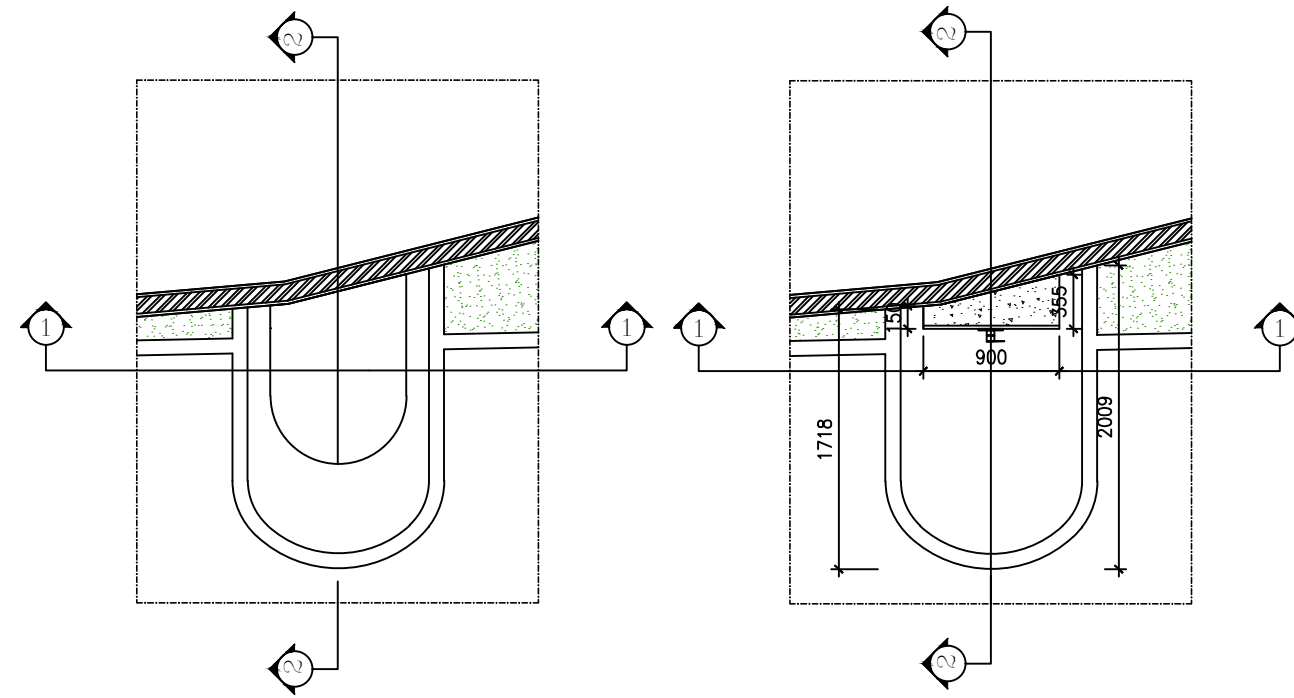

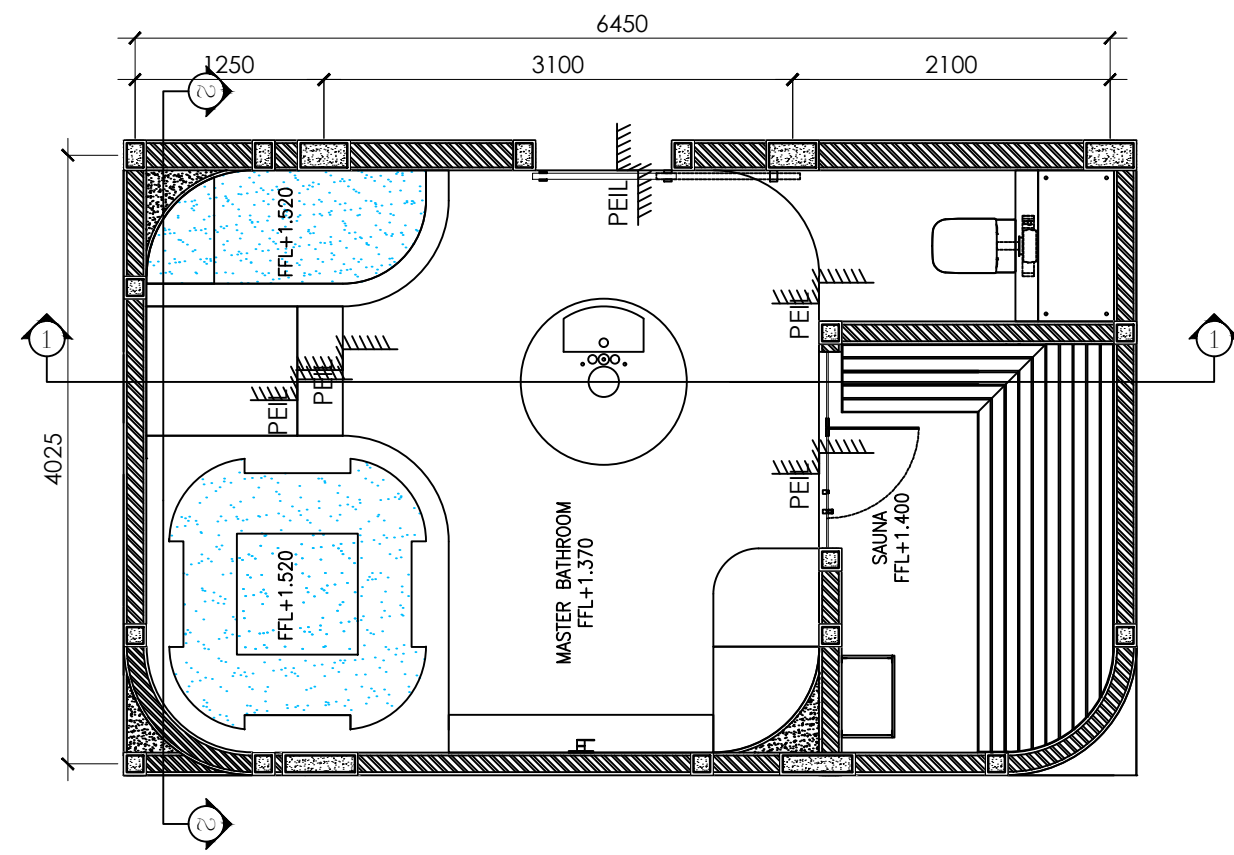
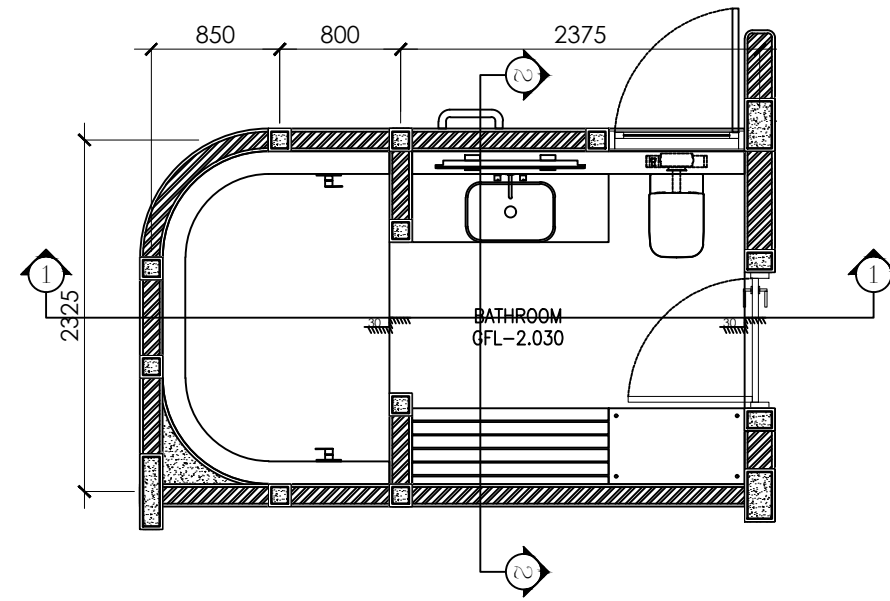

BATHROOM PLAN VILLA A
Scale 1 : 50

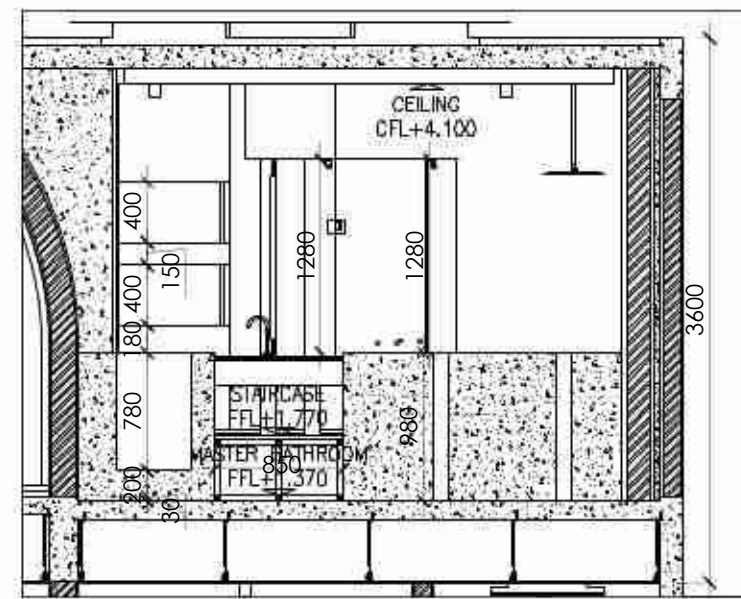
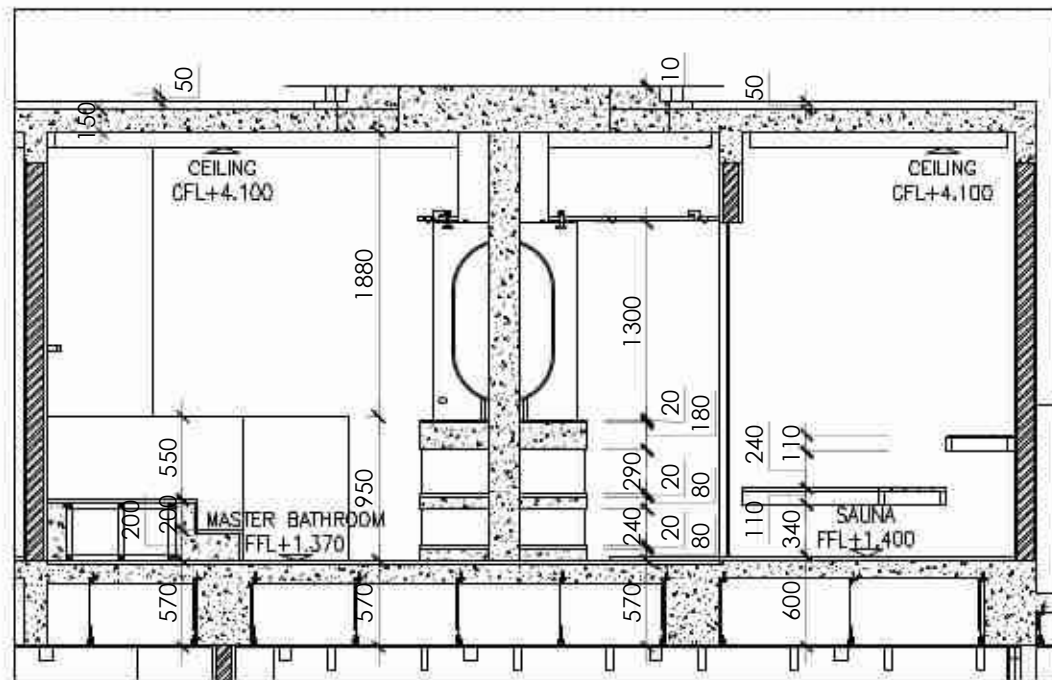
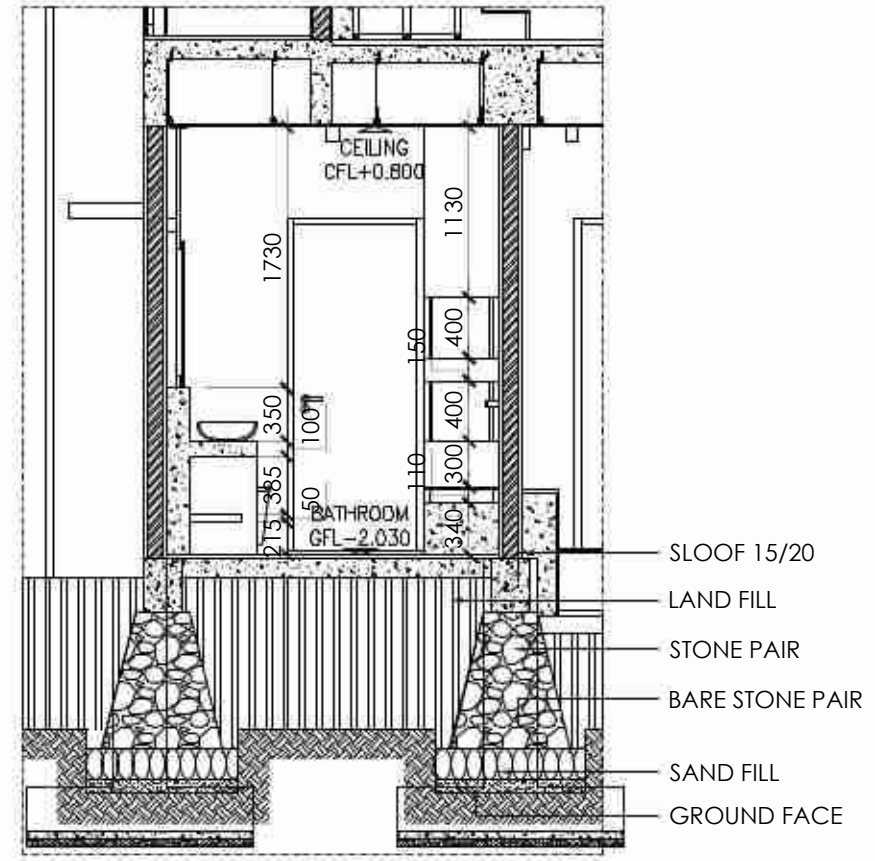
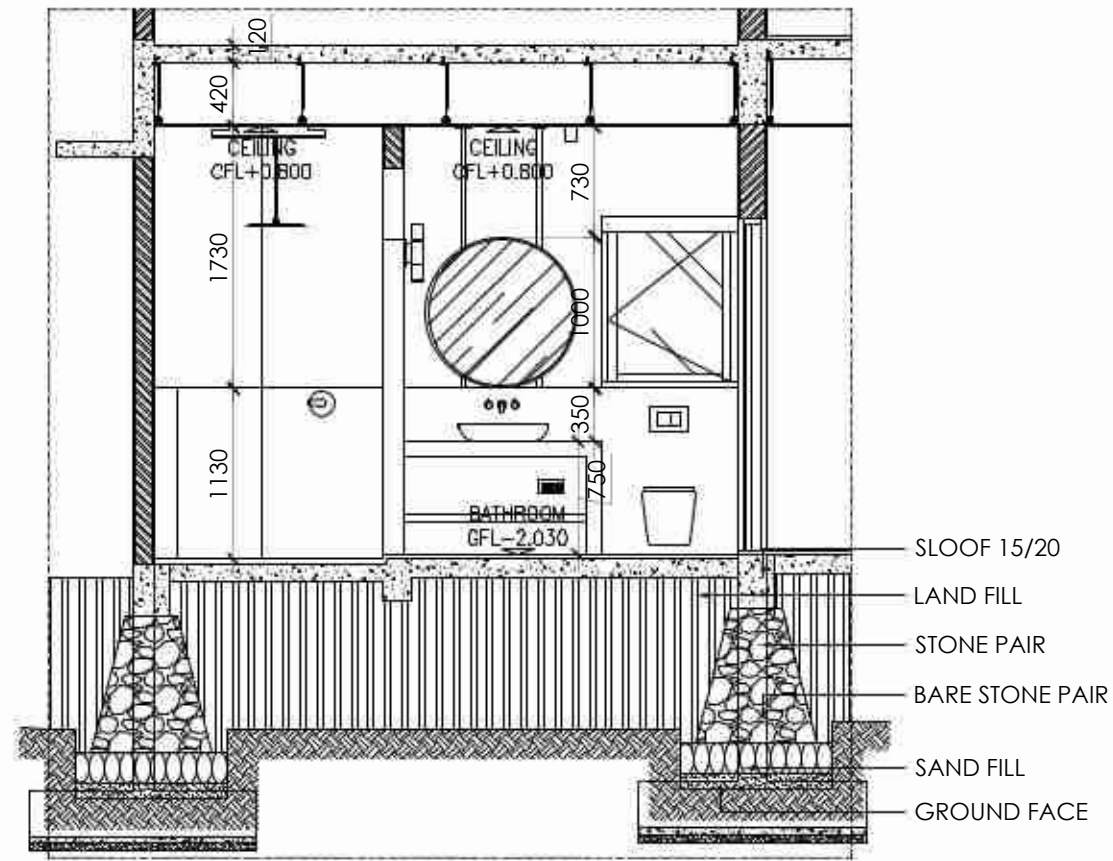

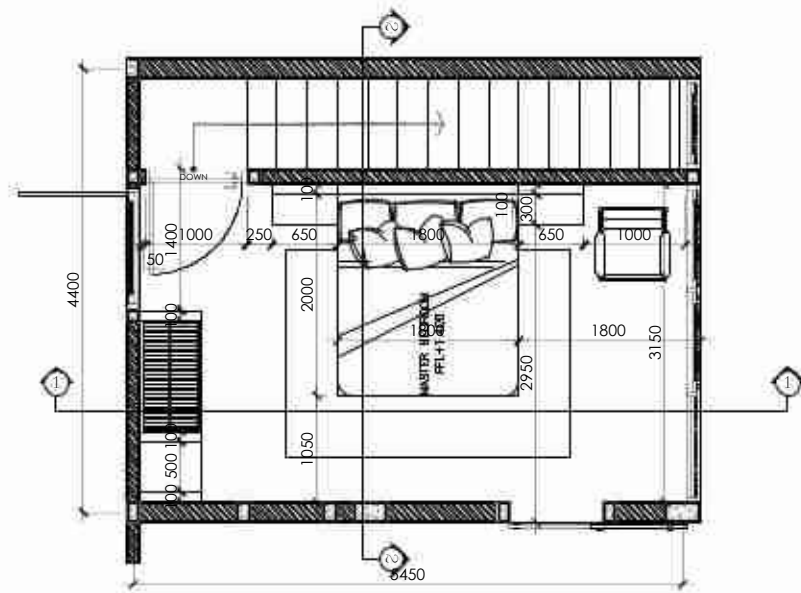
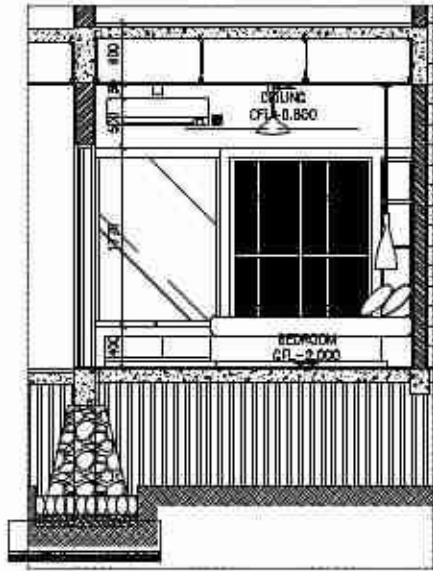
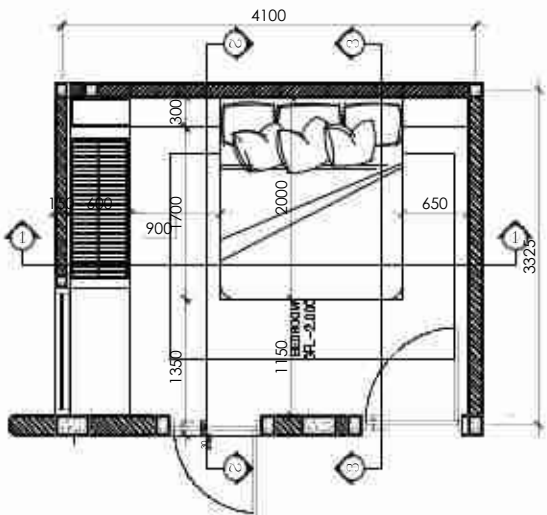
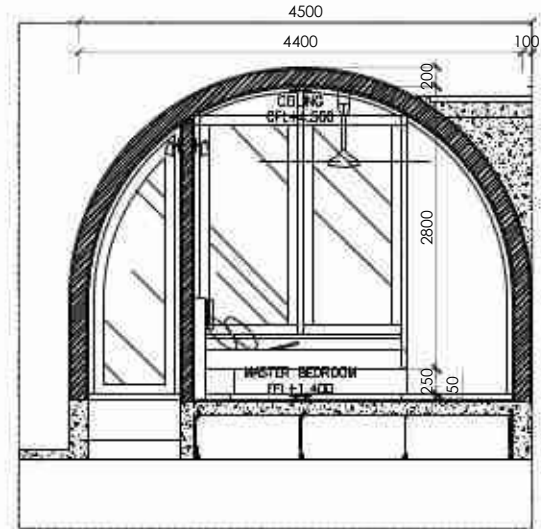
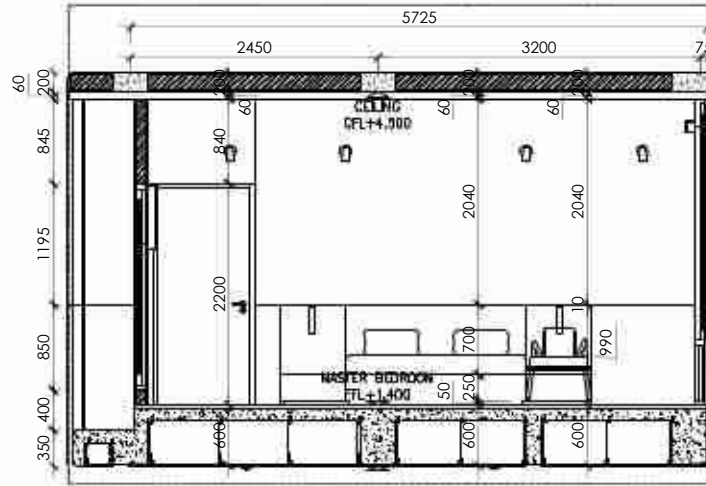
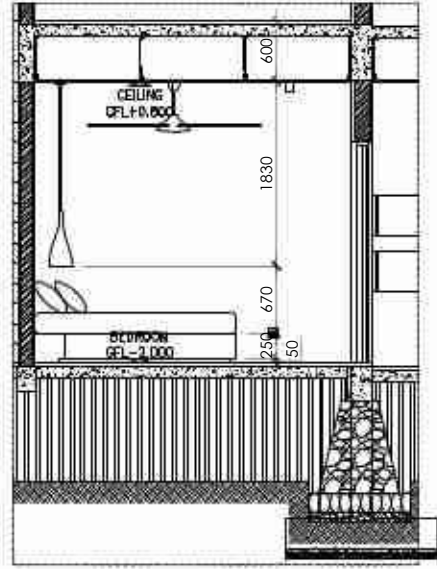
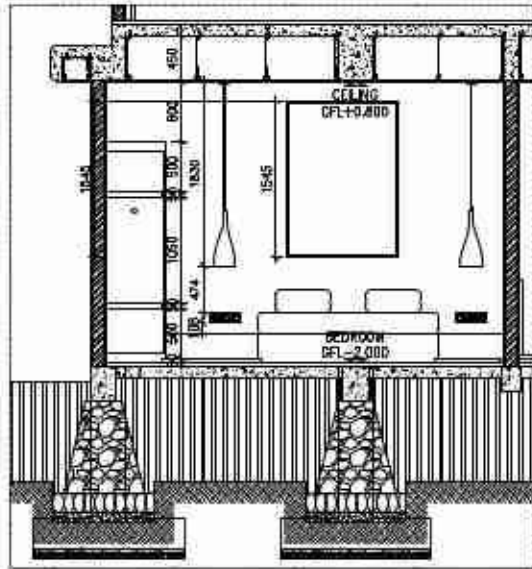

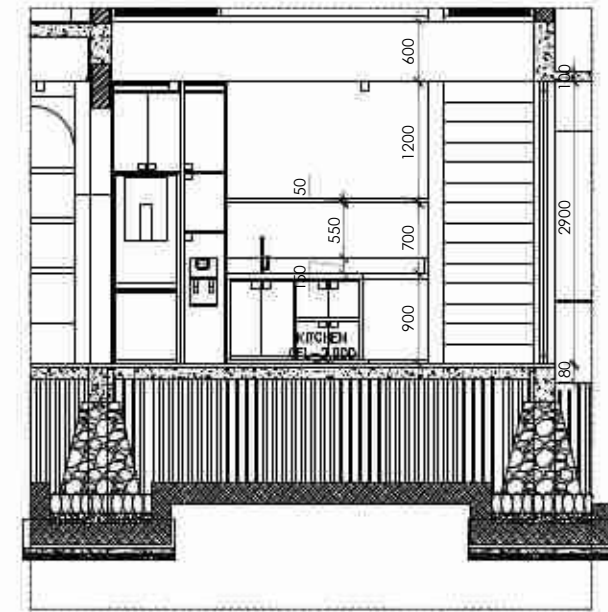
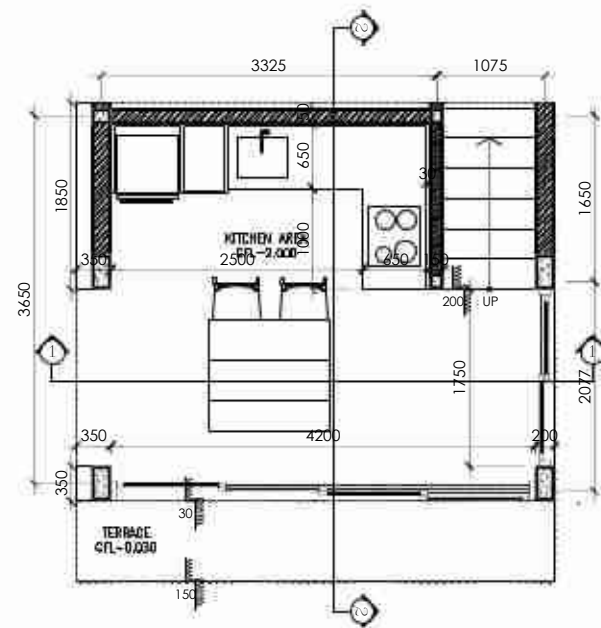
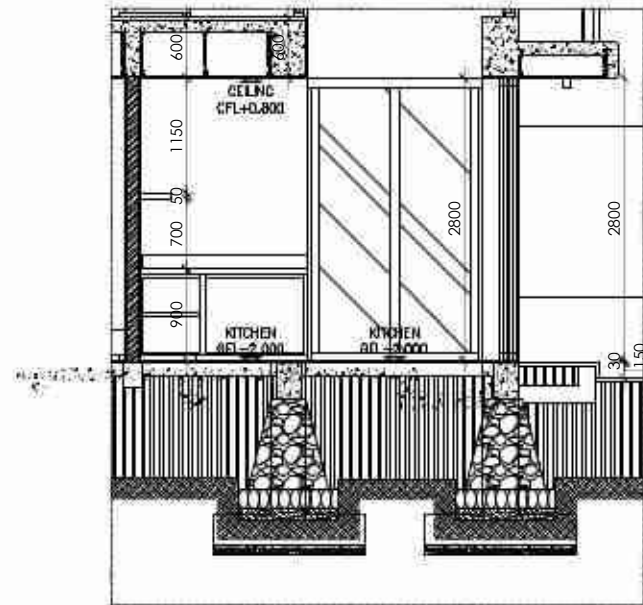

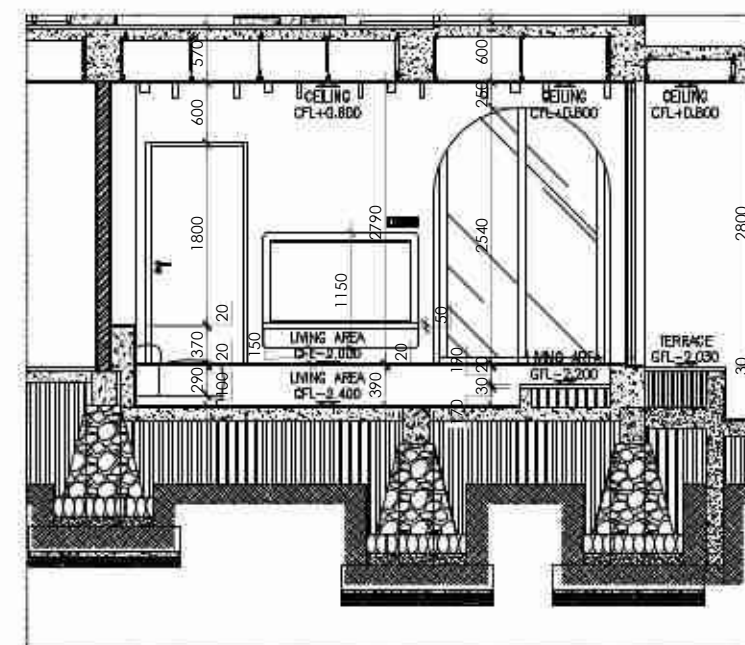
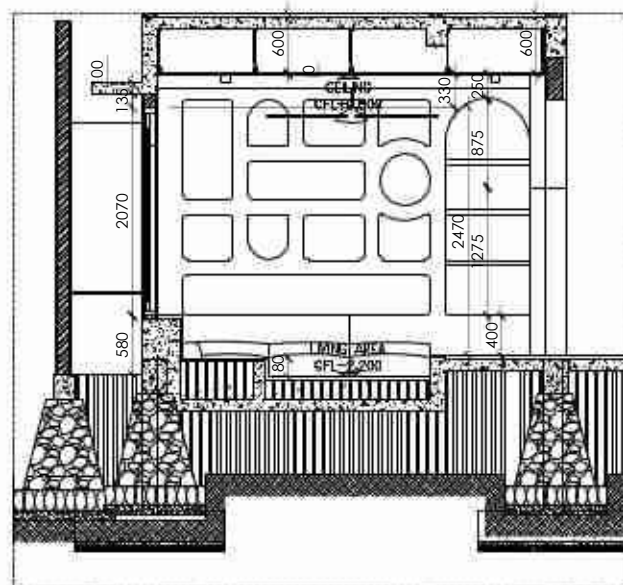
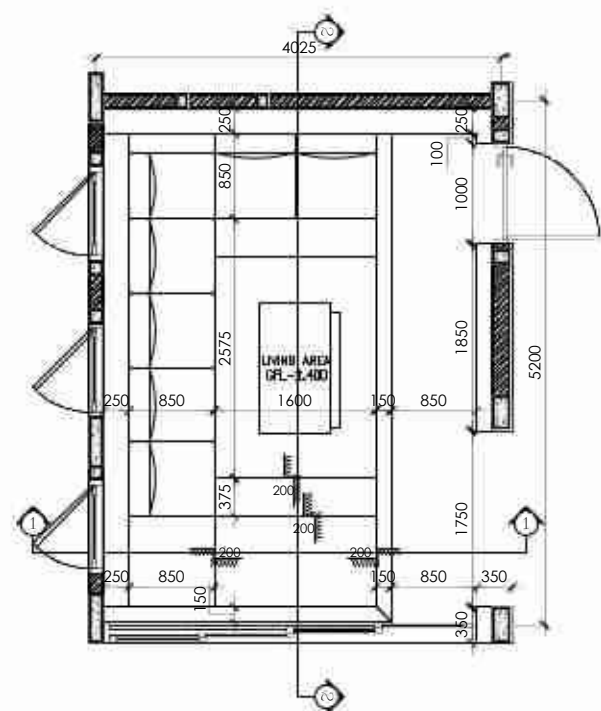

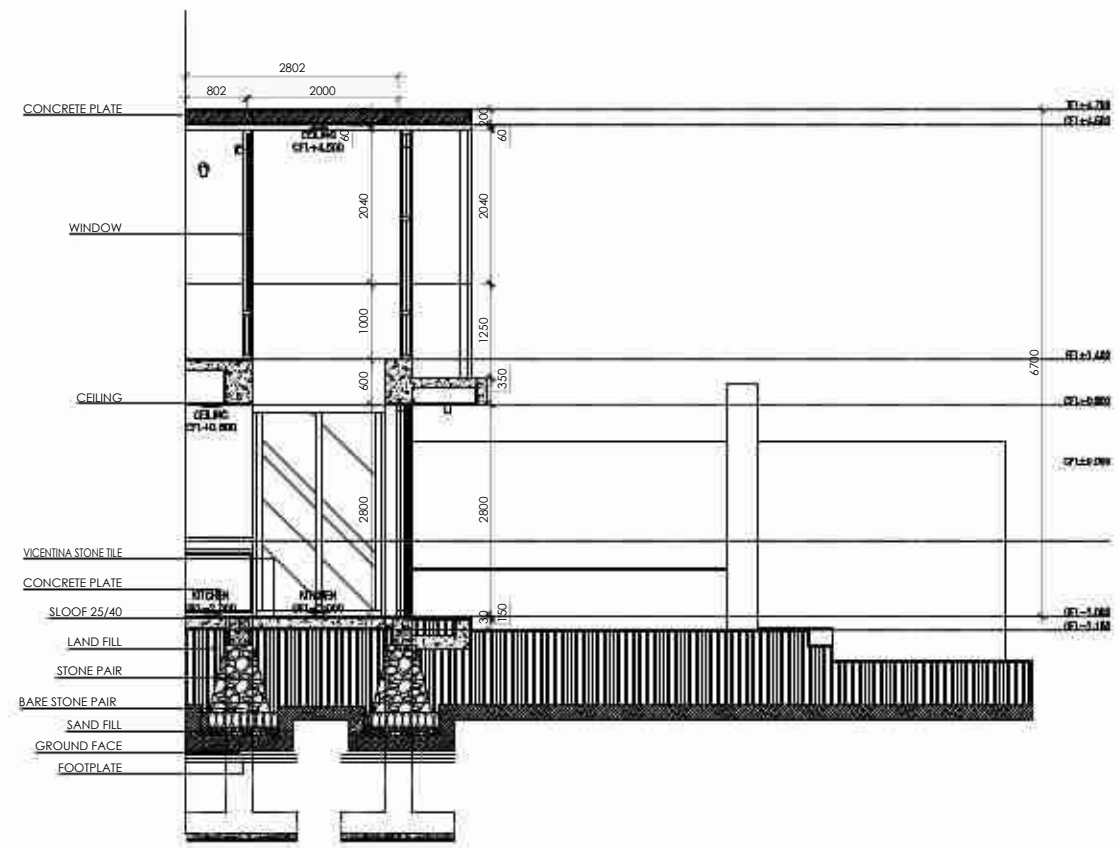
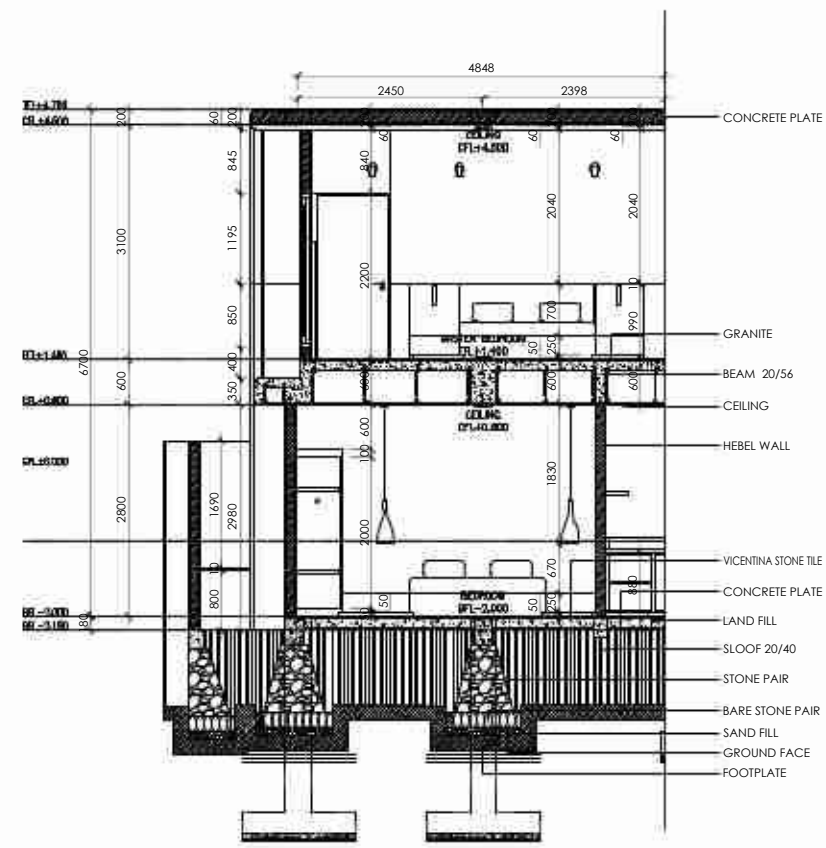
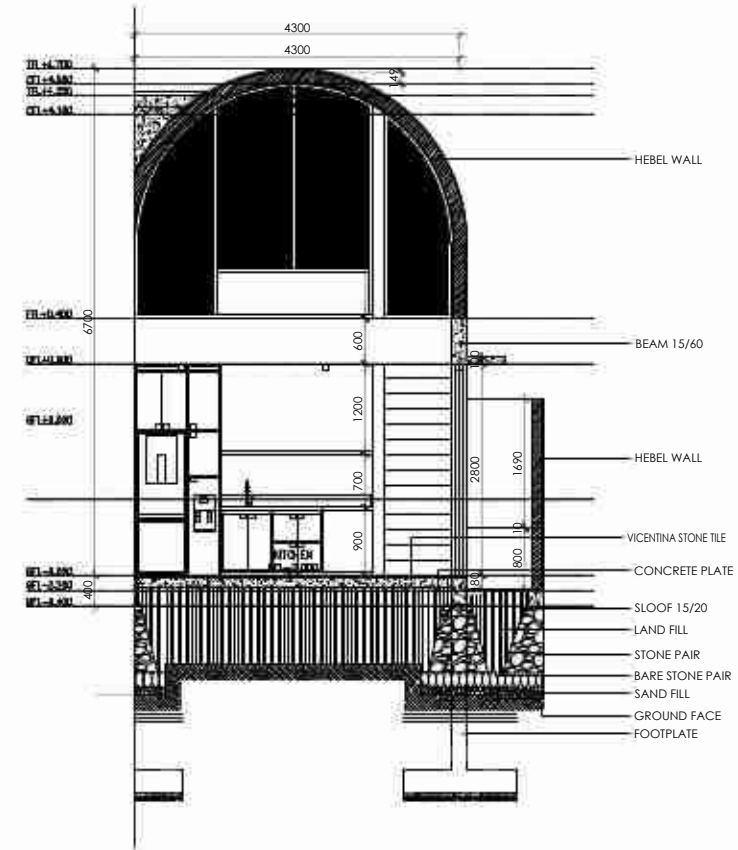
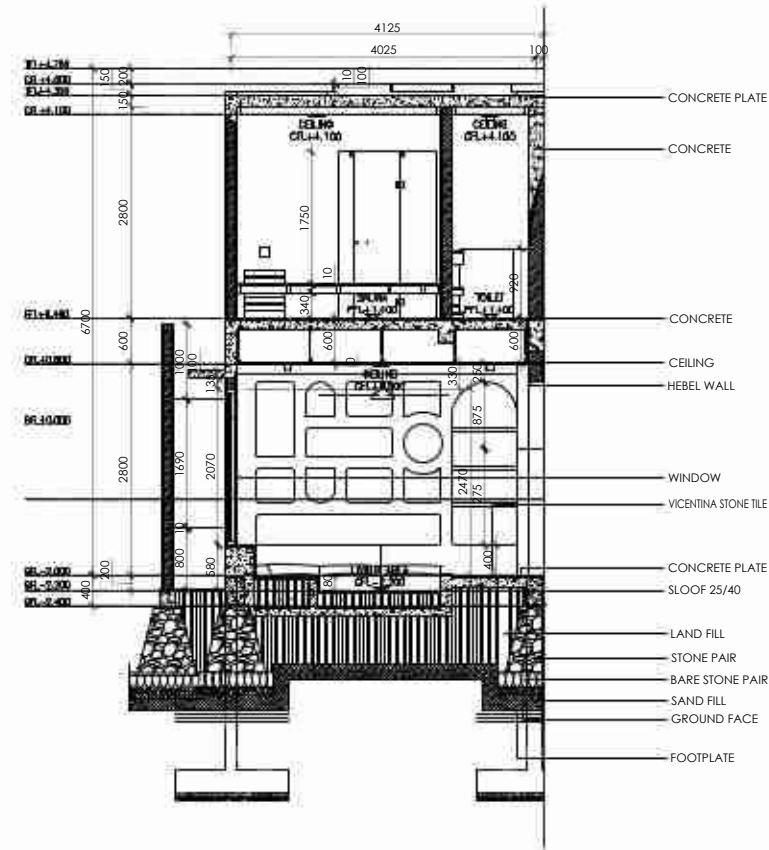

BLOW UP SECTION 1 VILLA A
Scale 1 : 100

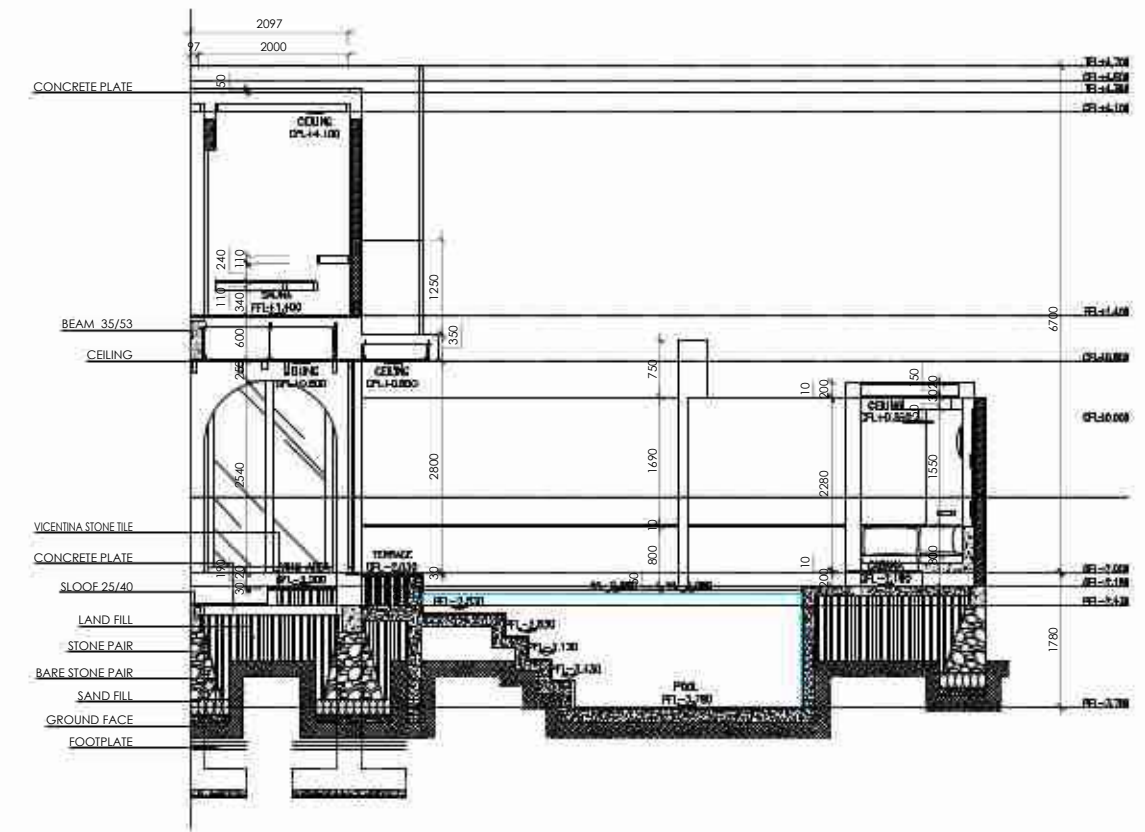
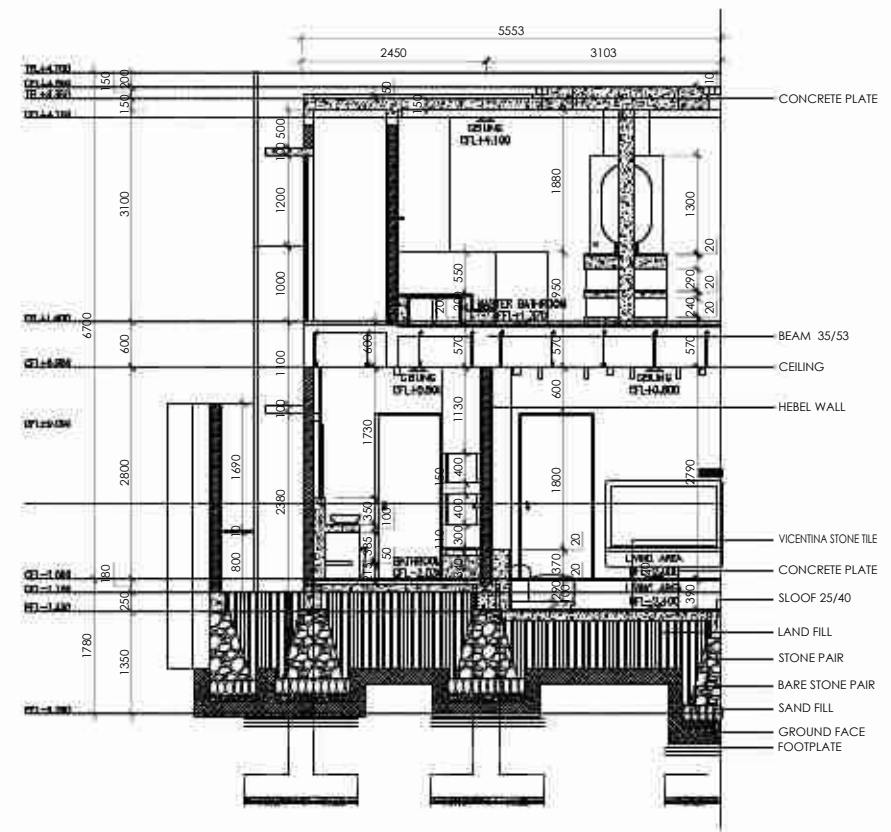
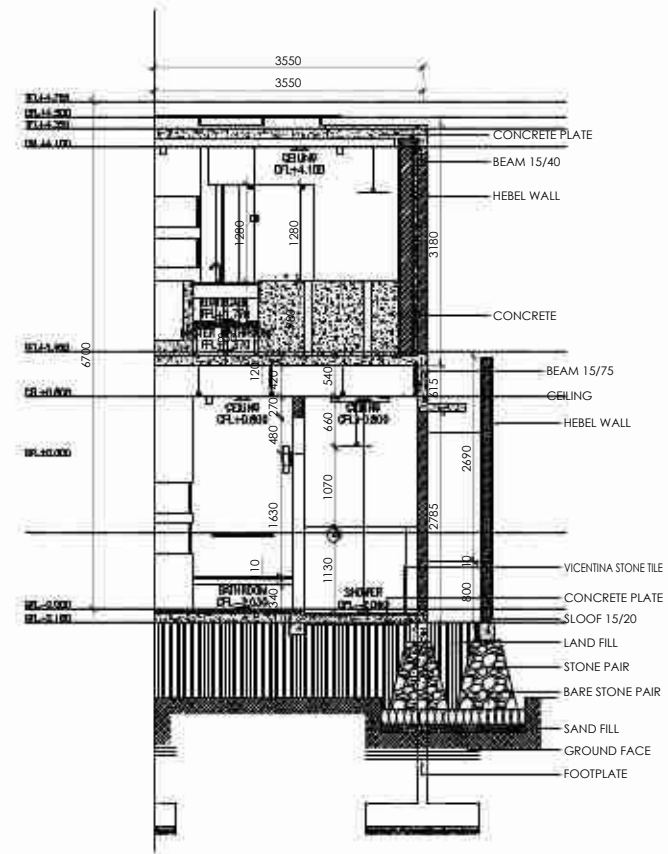
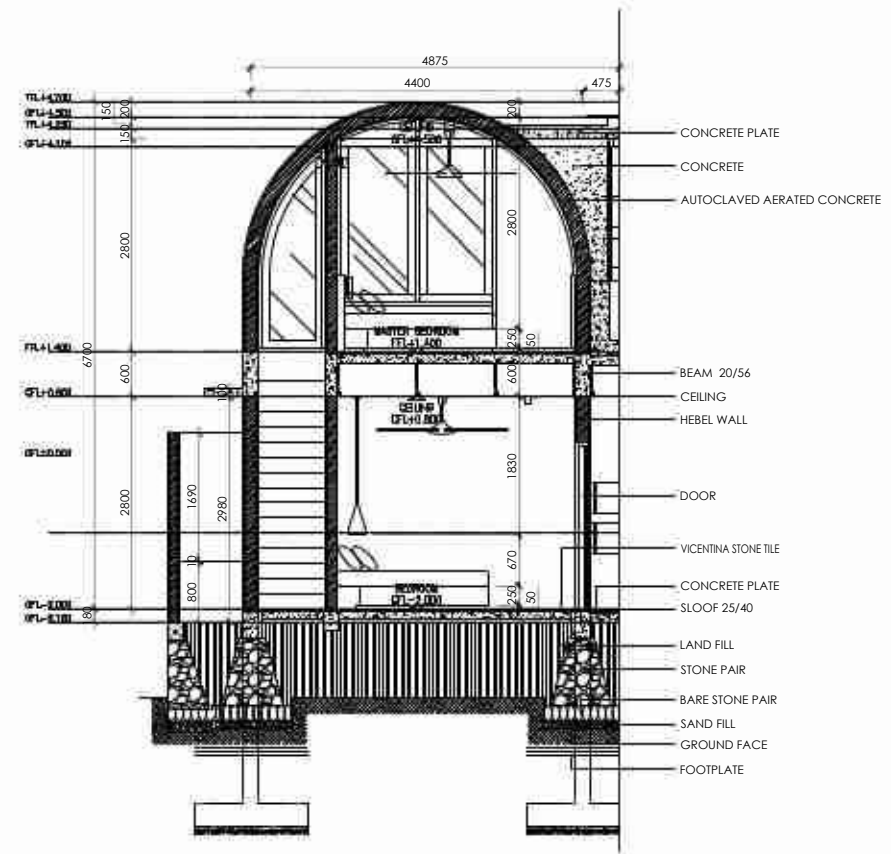

BLOW UP SECTION 2 VILLA A
Scale 1 : 100

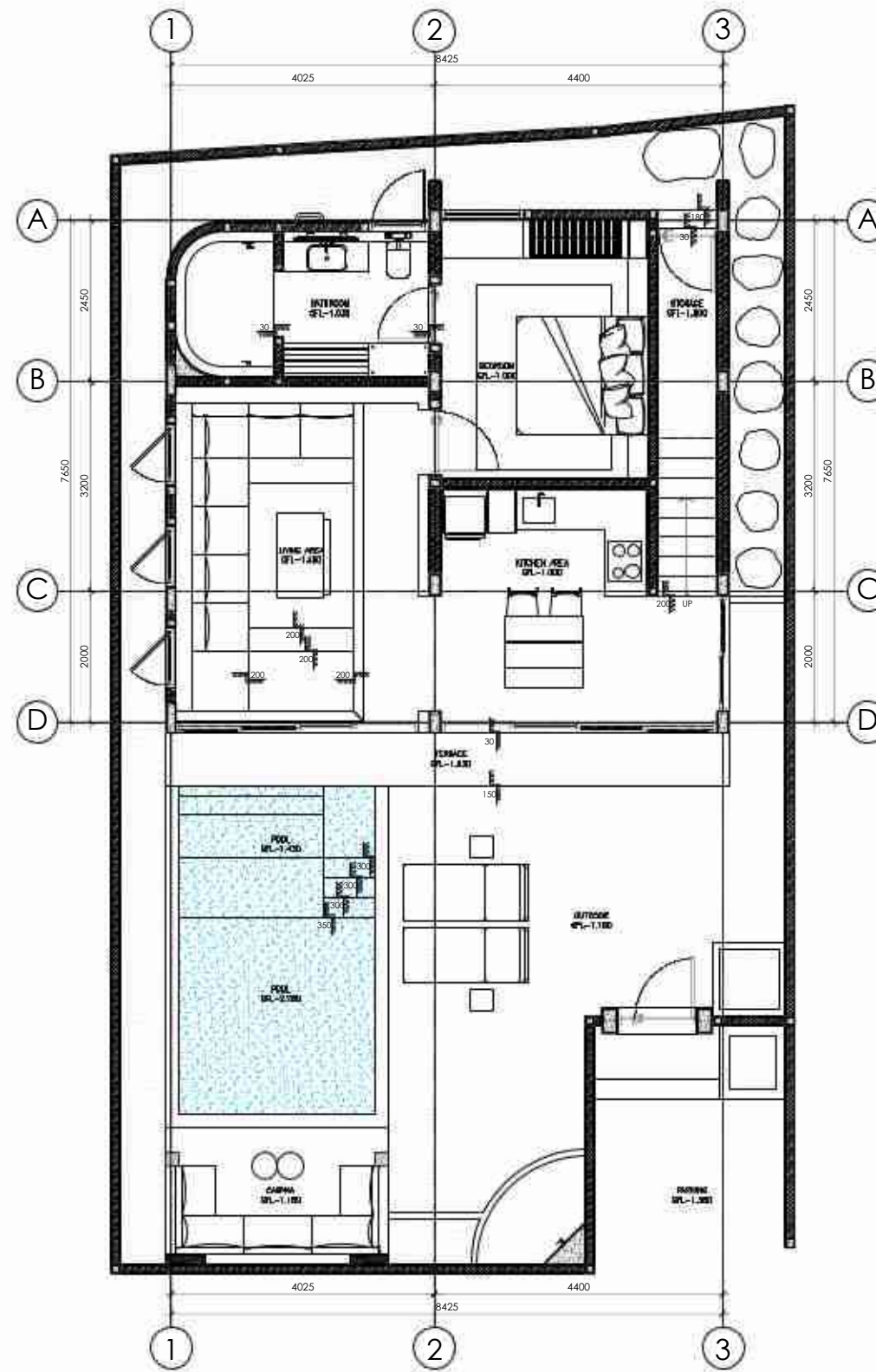

GROUND FLOOR PLAN VILLA B
Scale 1 : 100

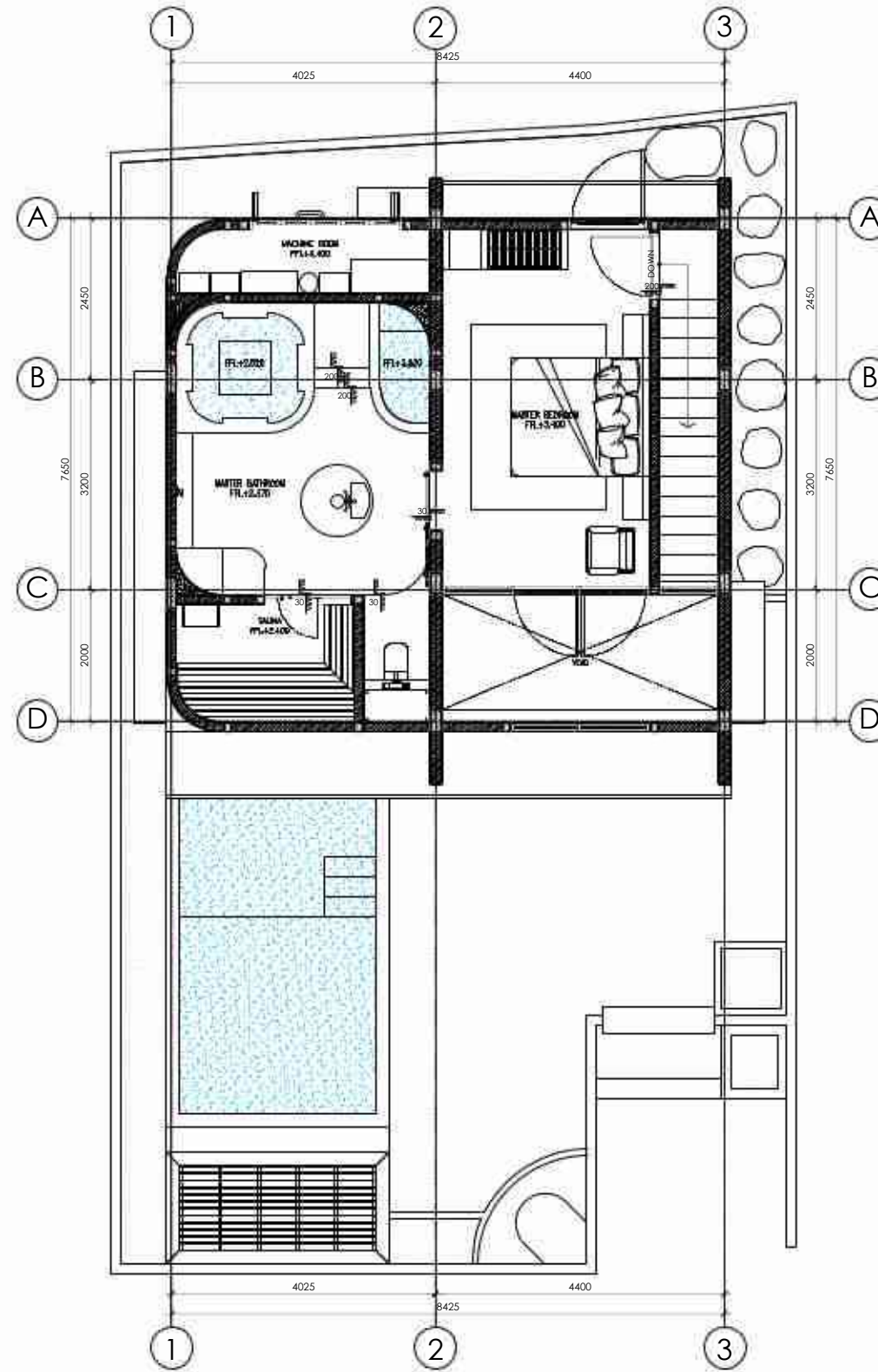

FIRST FLOOR PLAN VILLA B
Scale 1 : 100

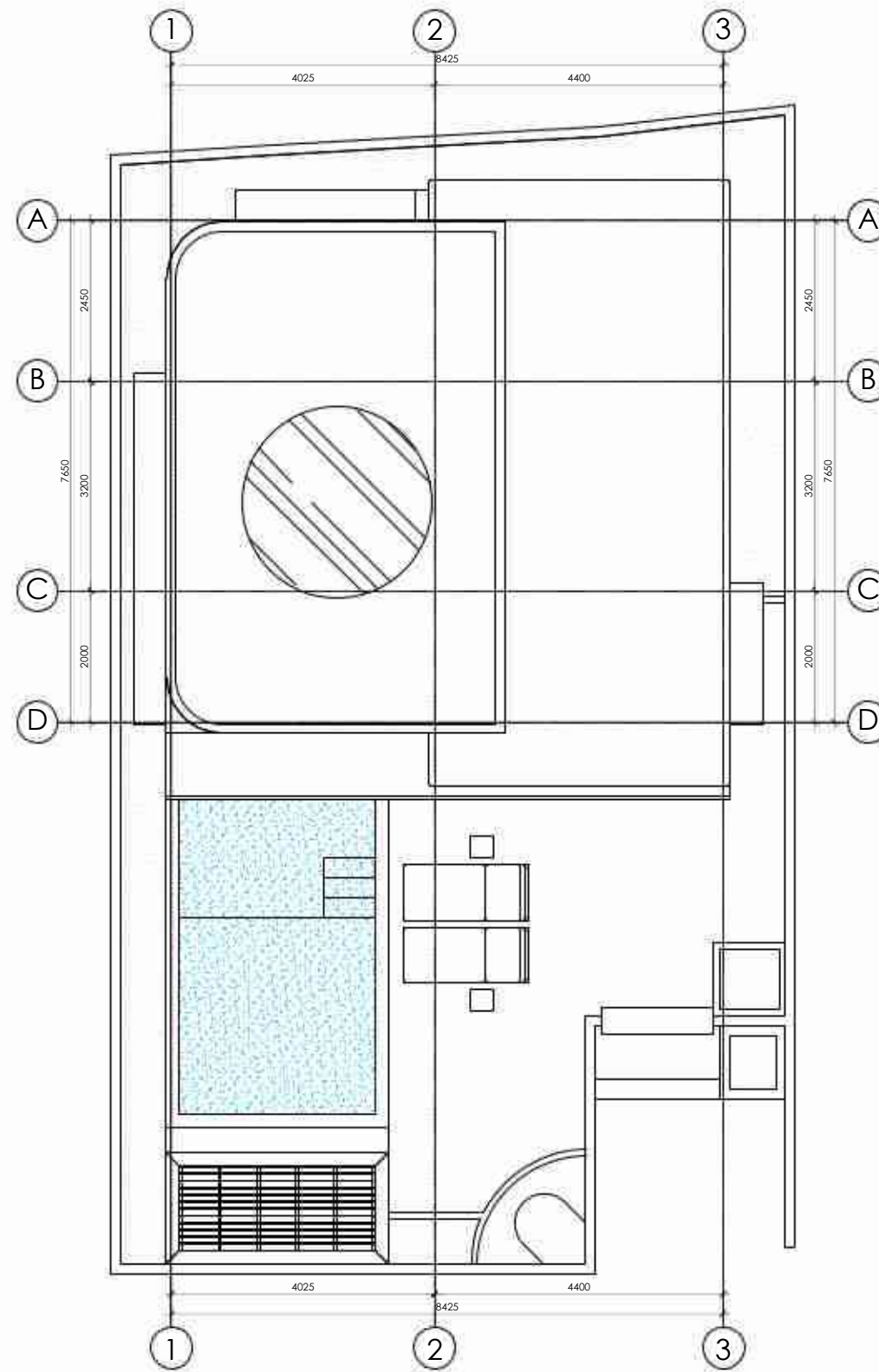

ROOF TOP PLAN VILLA B
Scale 1 : 100

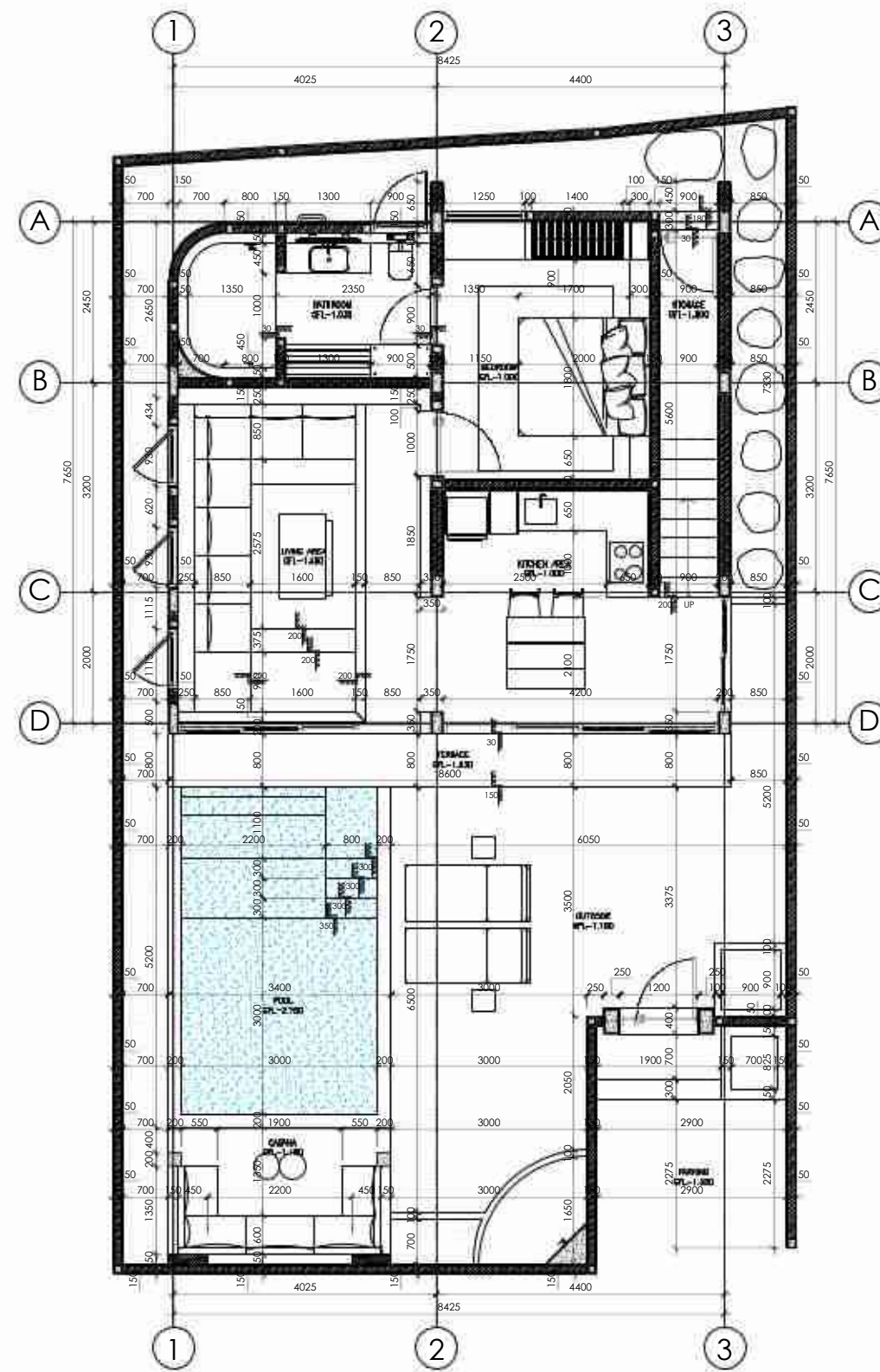

GROUND FLOOR DIMENSION PLAN VILLA B
Scale 1 : 100

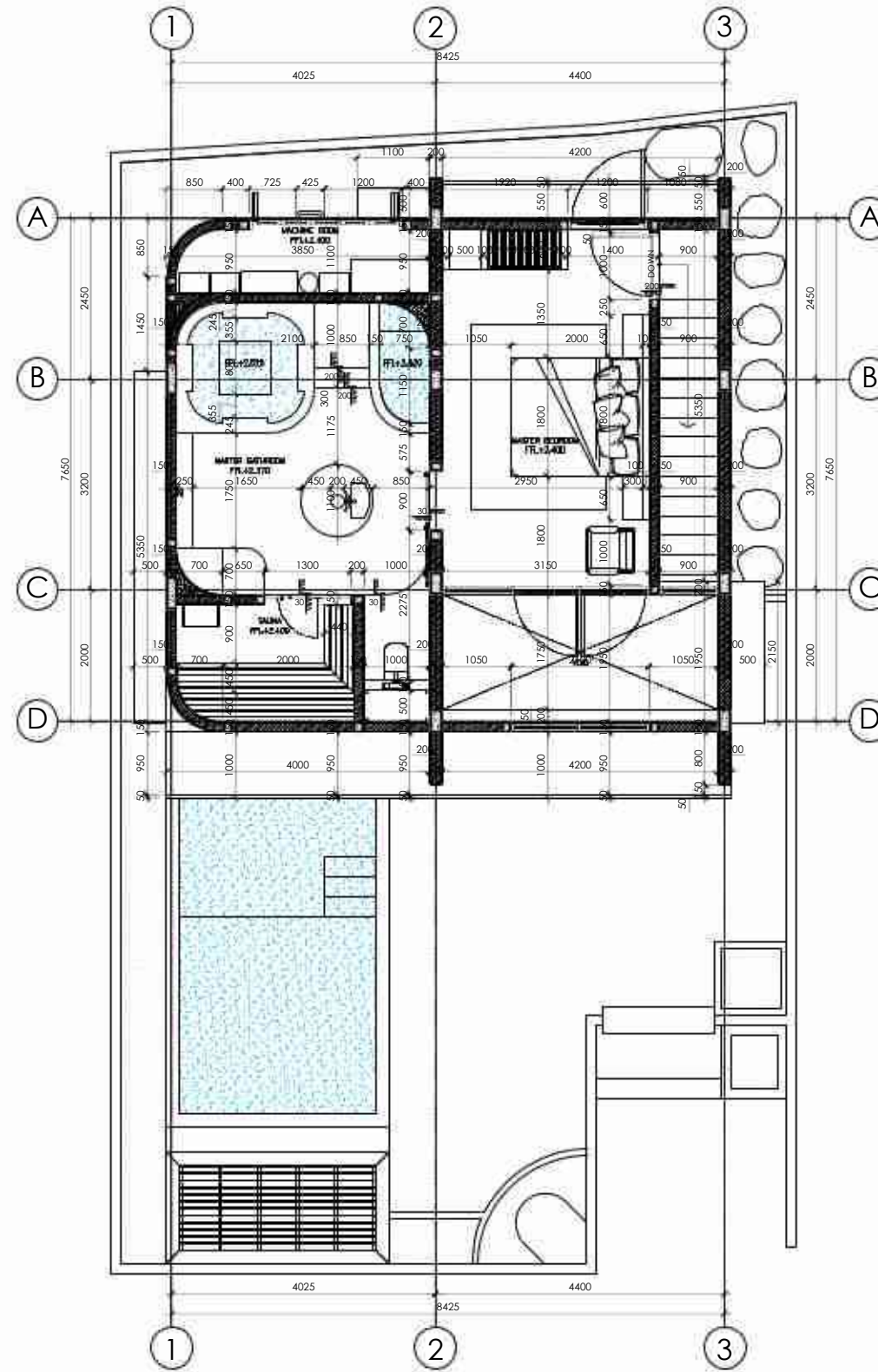

FIRST FLOOR DIMENSION PLAN VILLA B
Scale 1 : 100

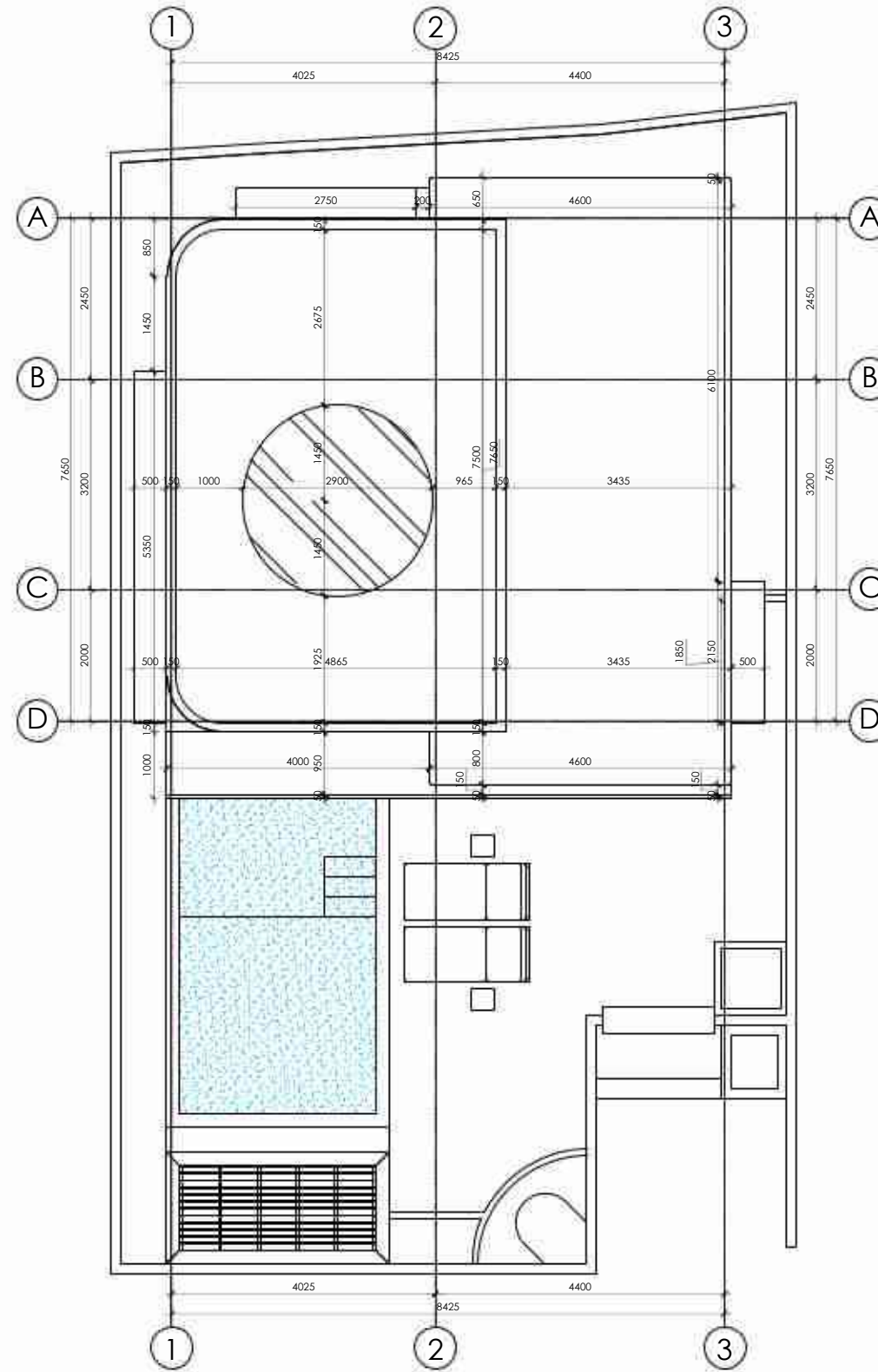

ROOF TOP DIMENSION PLAN VILLA B
Scale 1 : 100

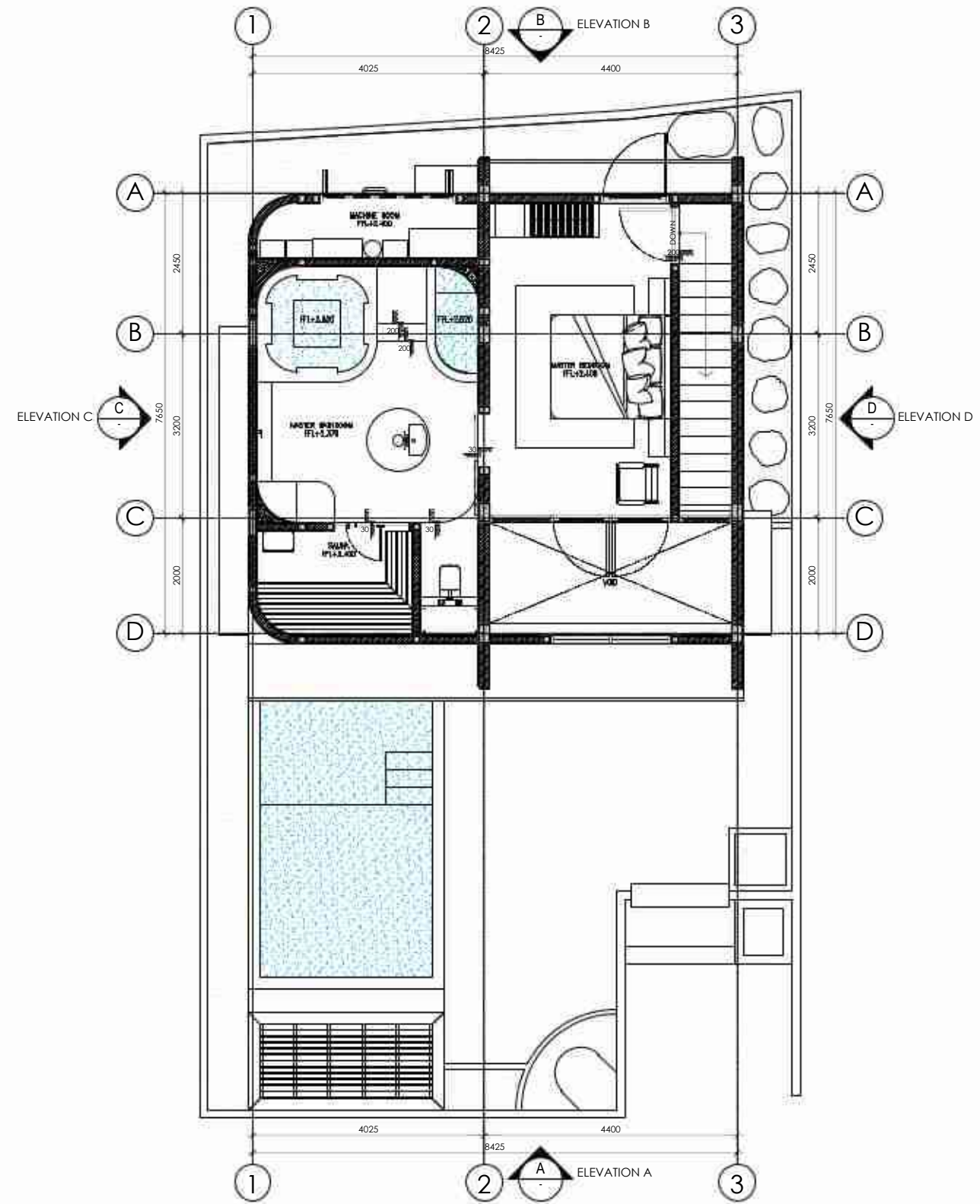
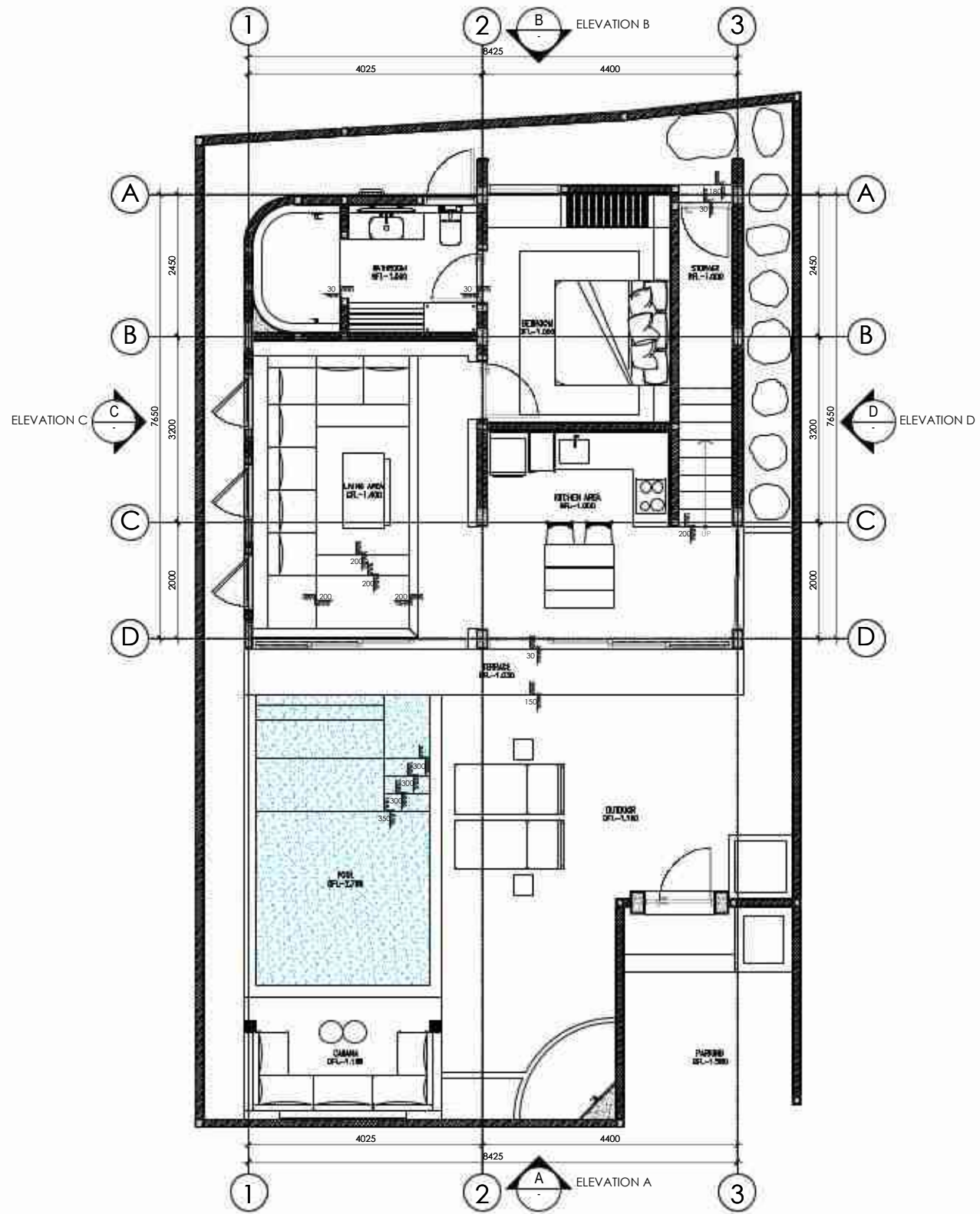

ELEVATION VILLA B
Scale 1 : 100

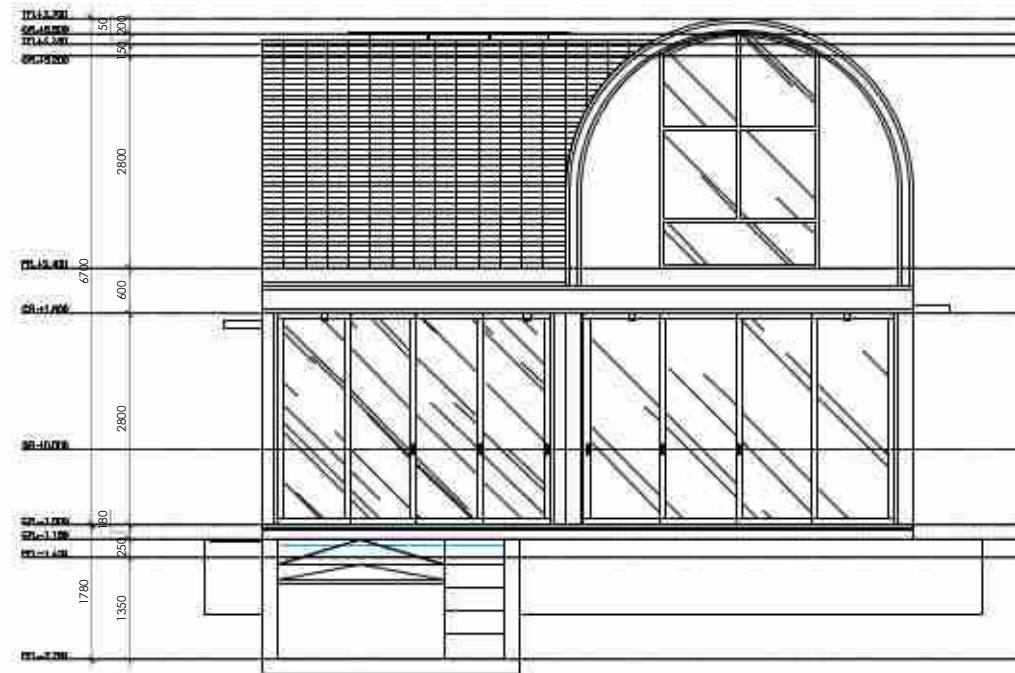
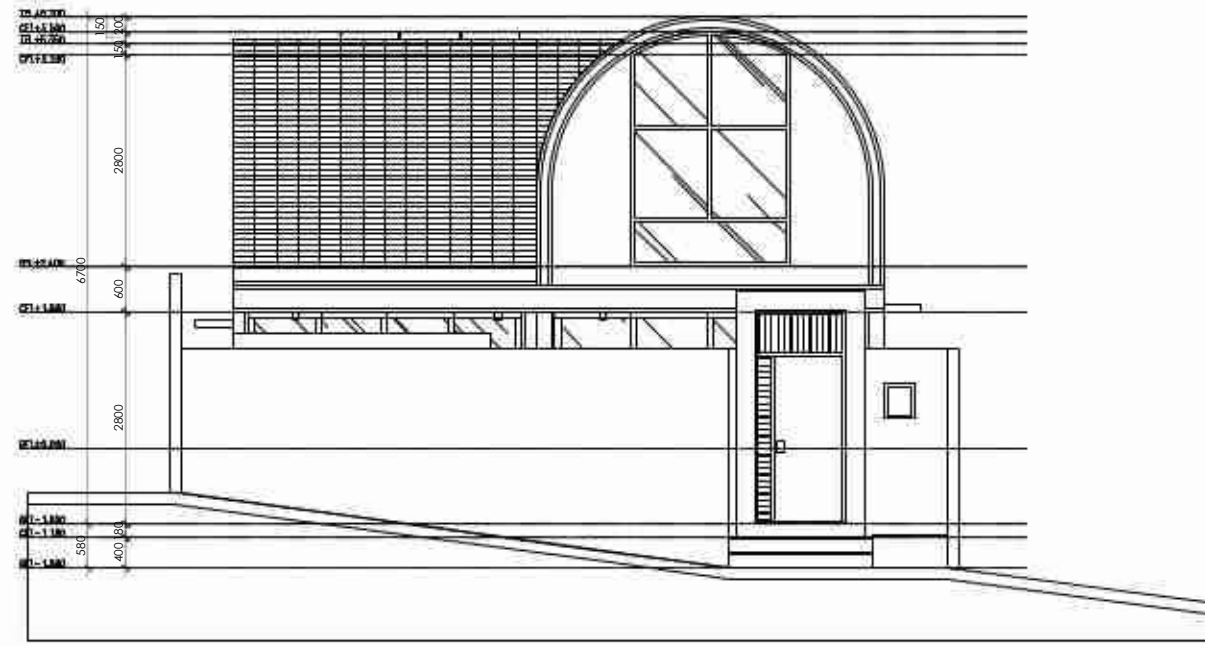

ELEVATION A-A VILLA B
Scale 1 : 100

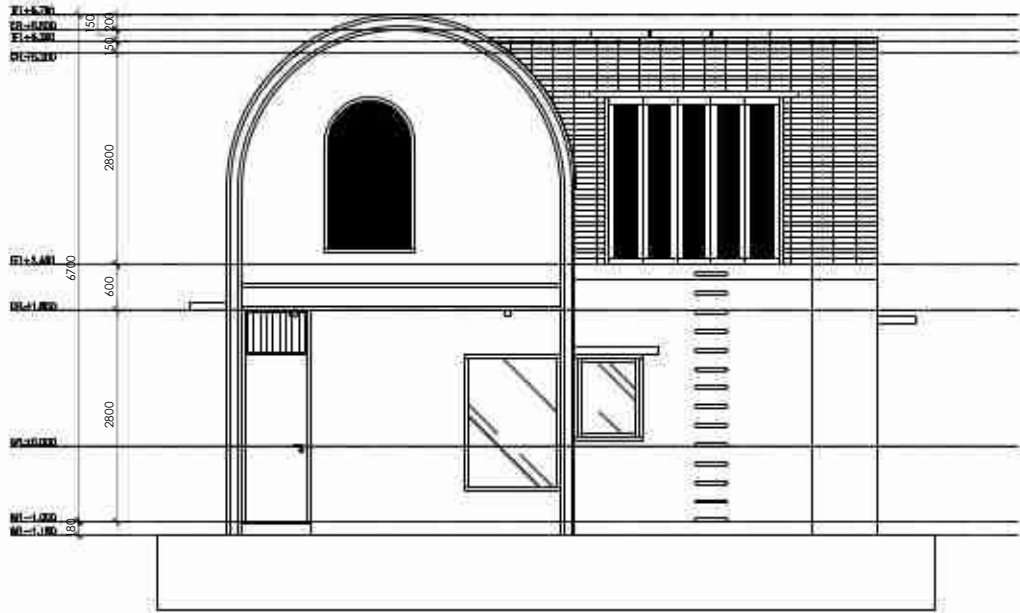
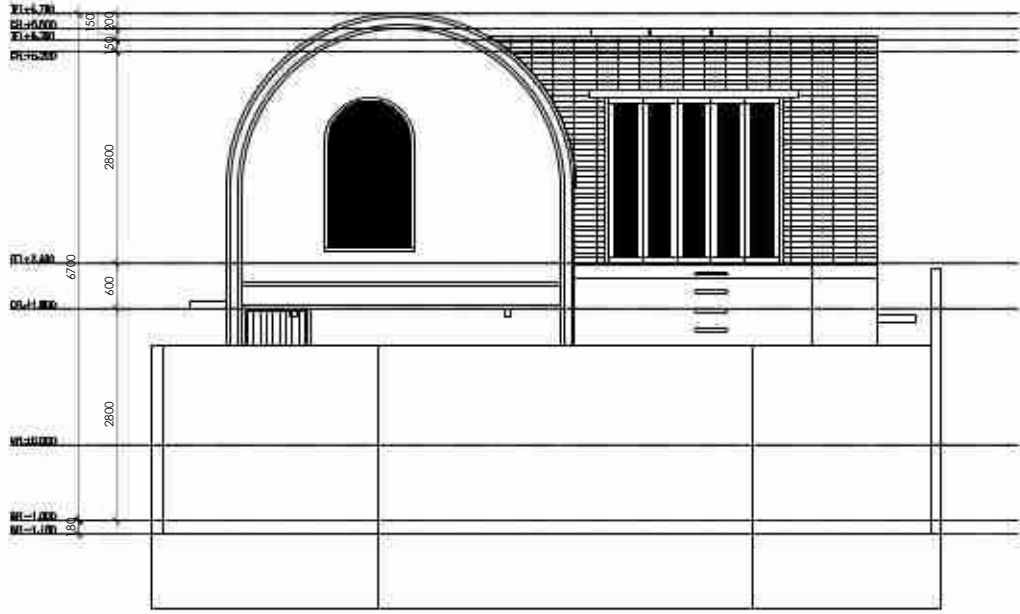

ELEVATION B-B VILLA B
Scale 1 : 100

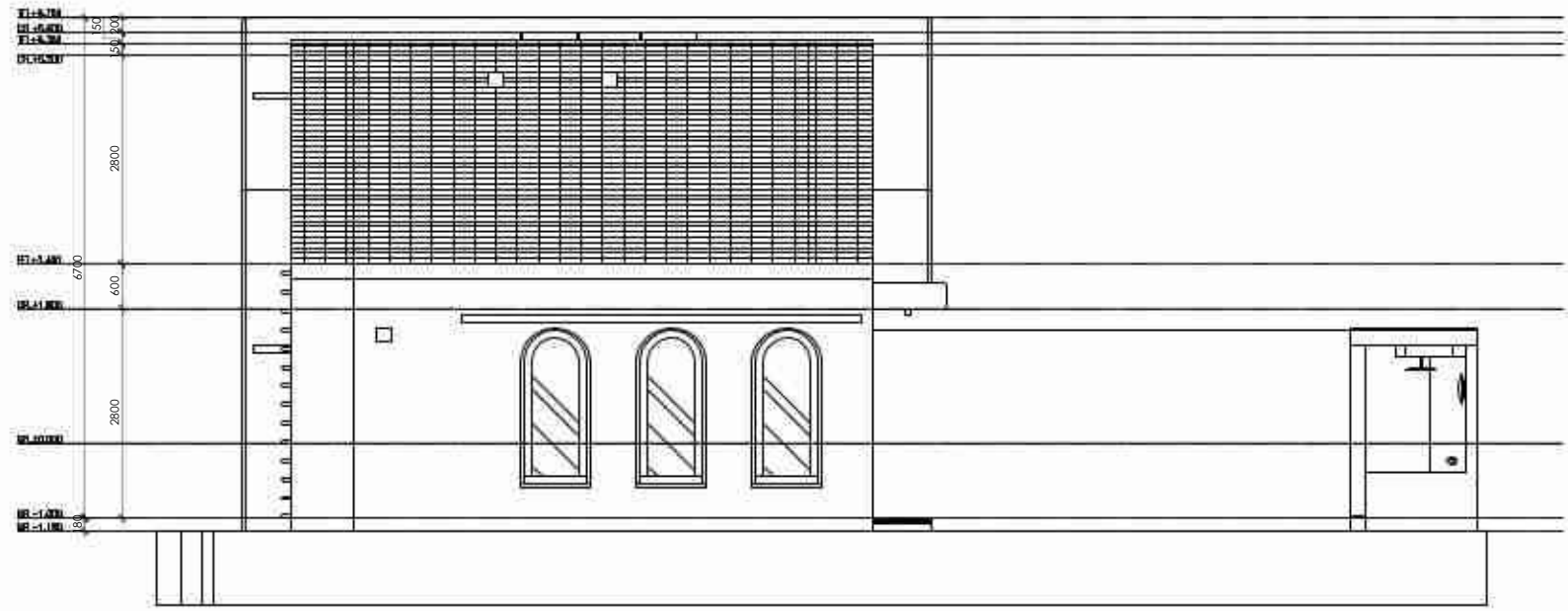
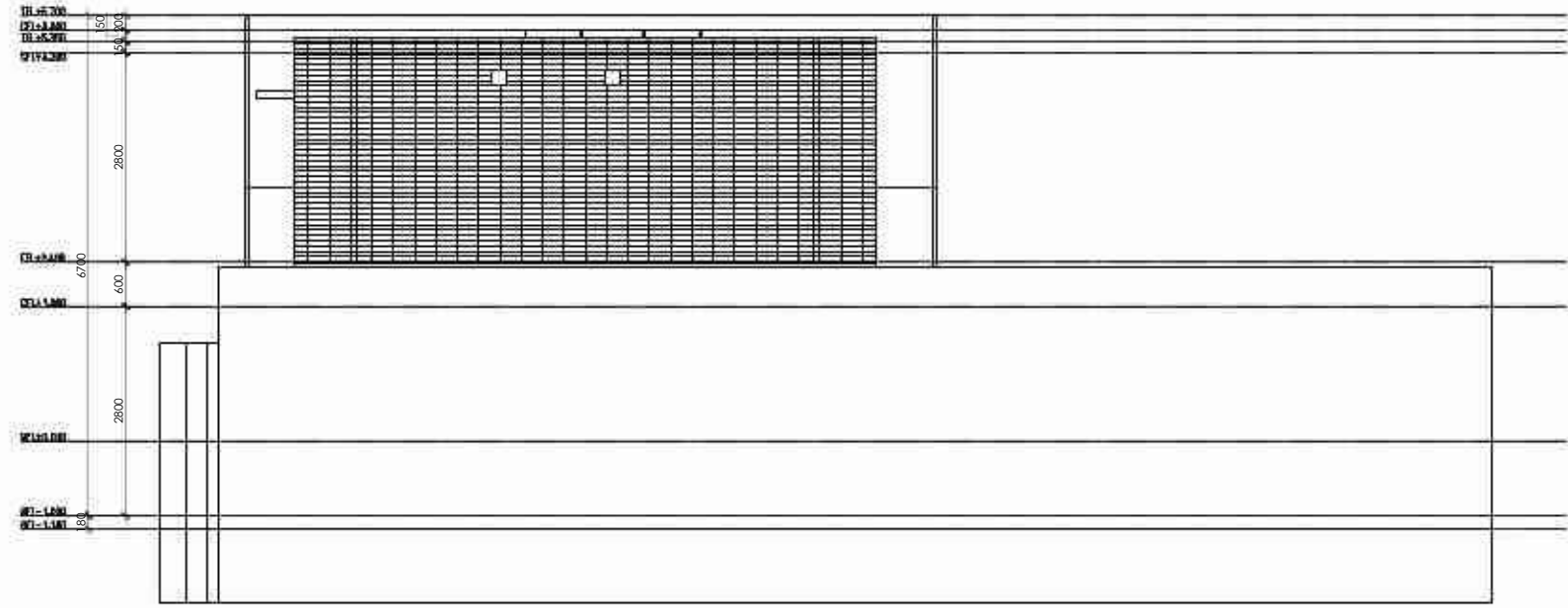

ELEVATION C-C SITE B
Scale 1 : 100

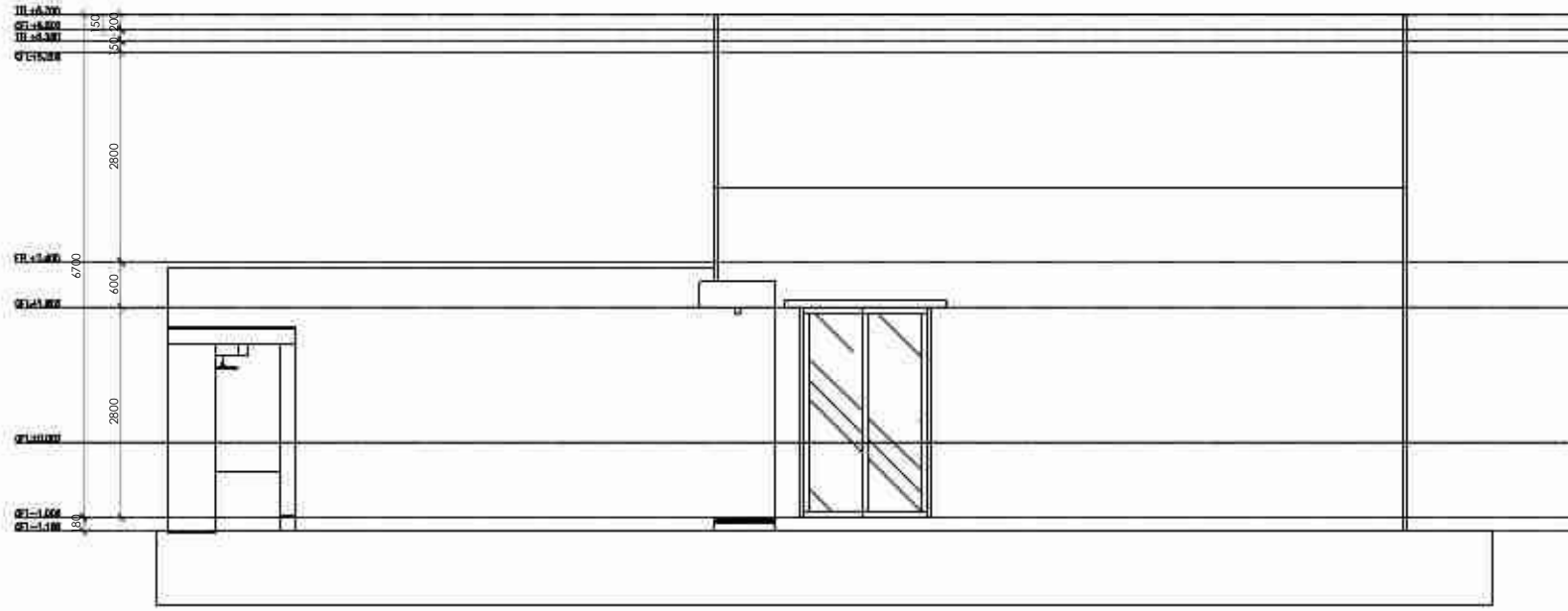
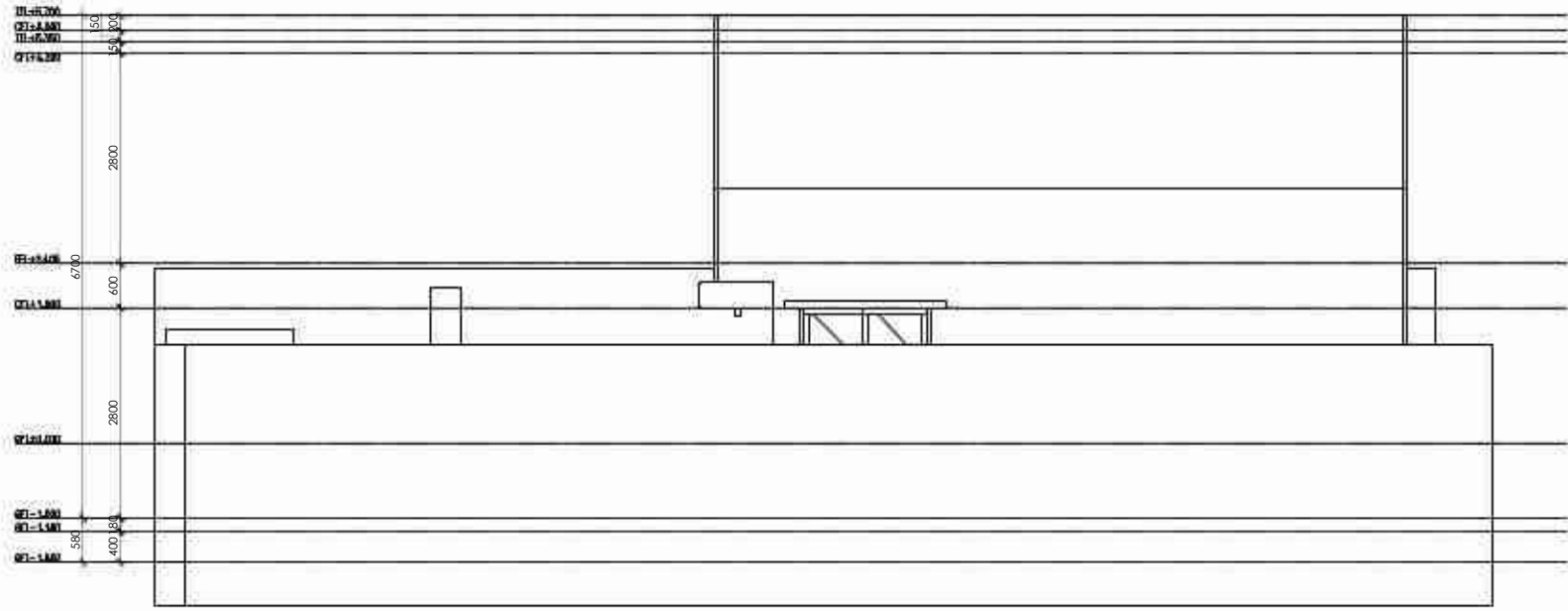

ELEVATION D-D VILLA B
Scale 1 : 100

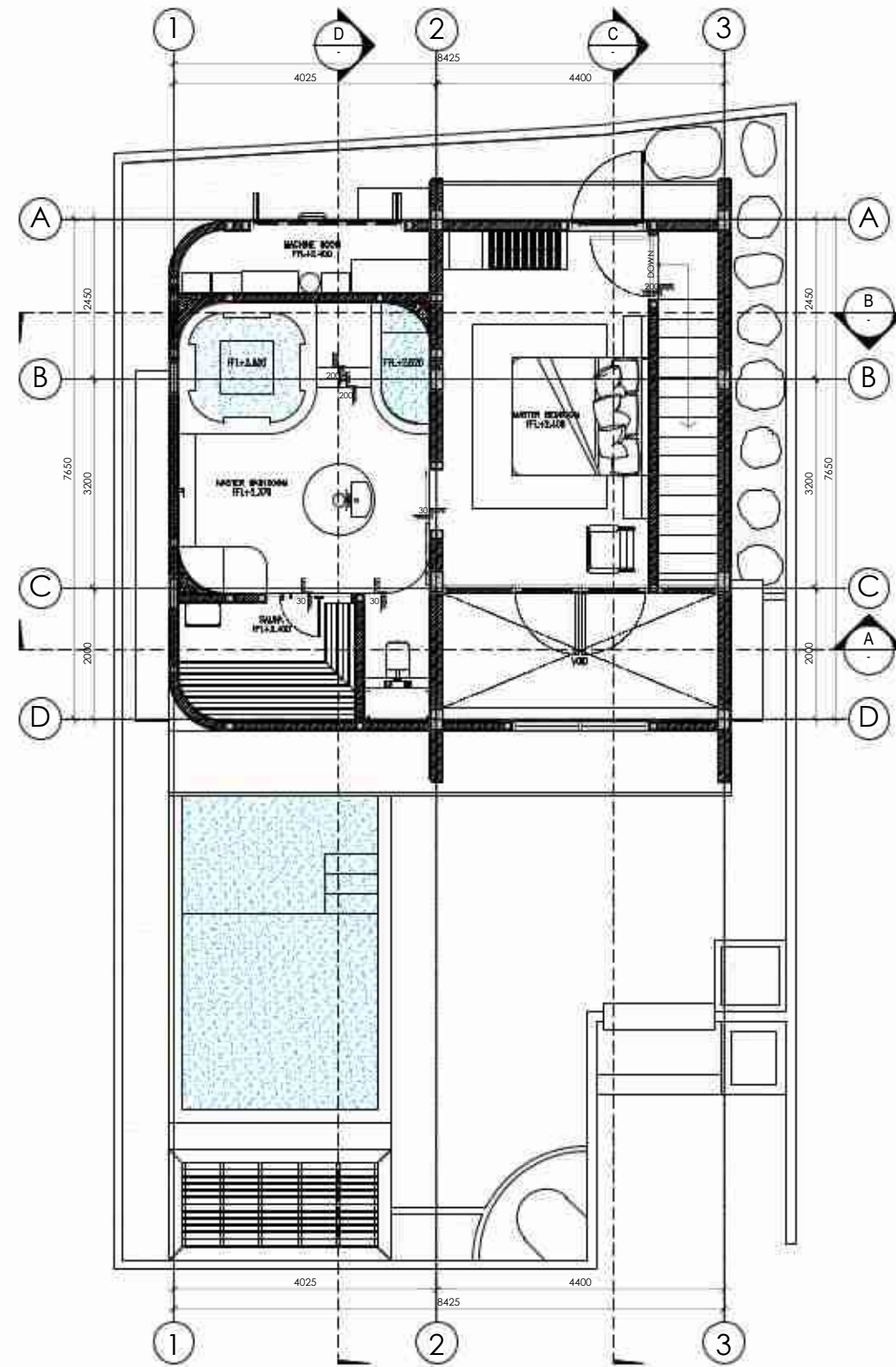
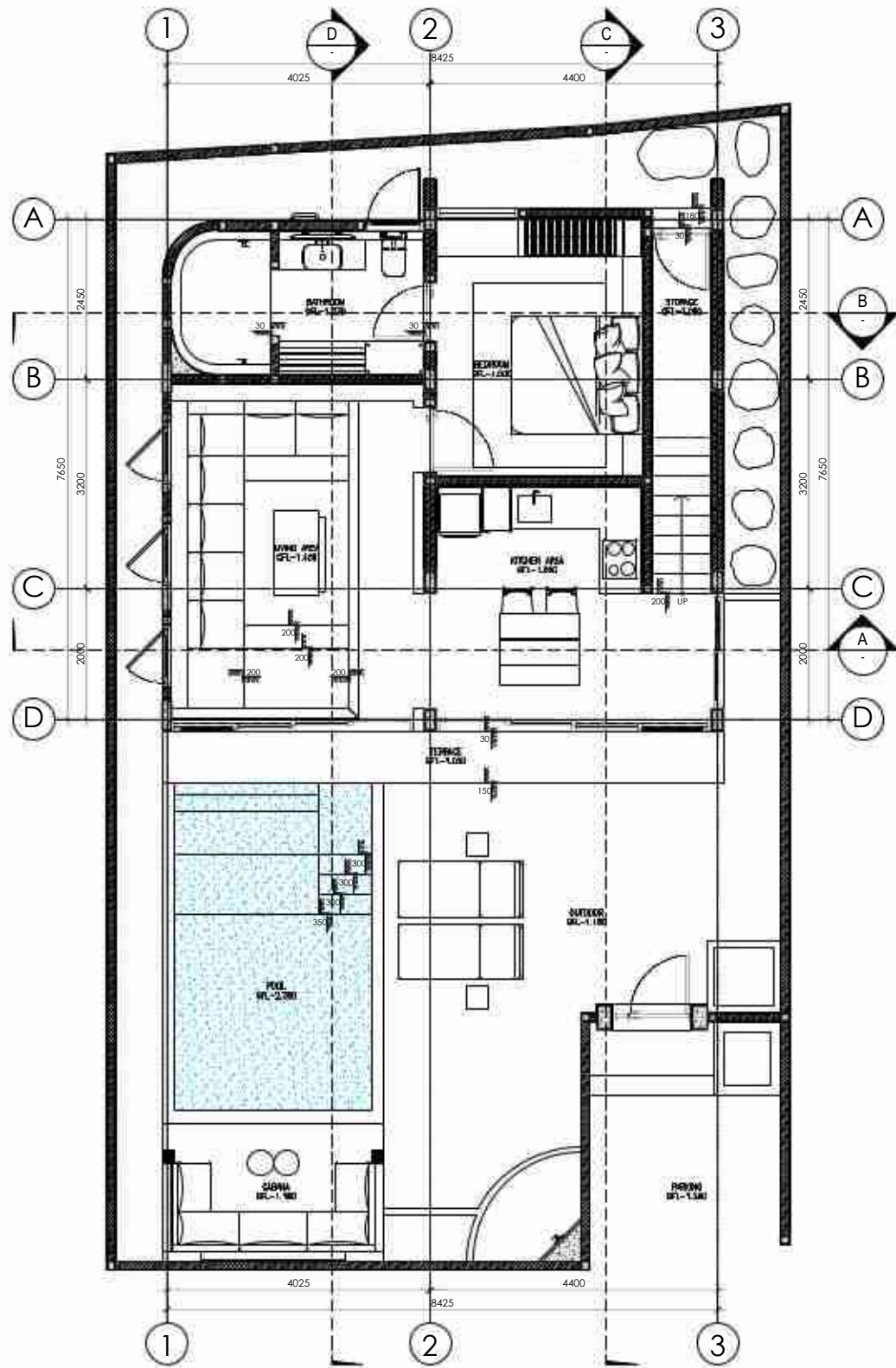

SECTION VILLA B
Scale 1 : 100

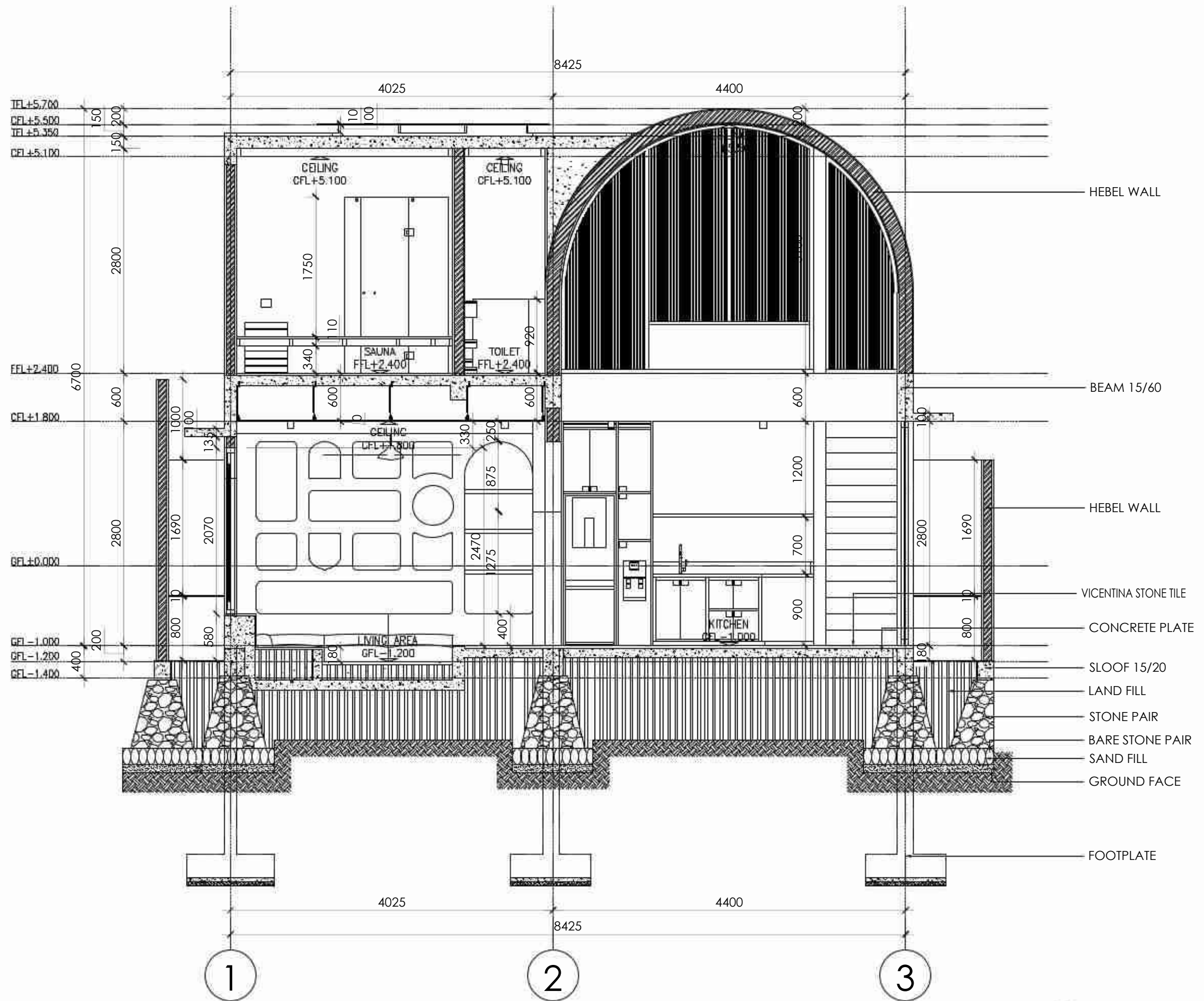

SECTION A-A VILLA B
Scale 1 : 50

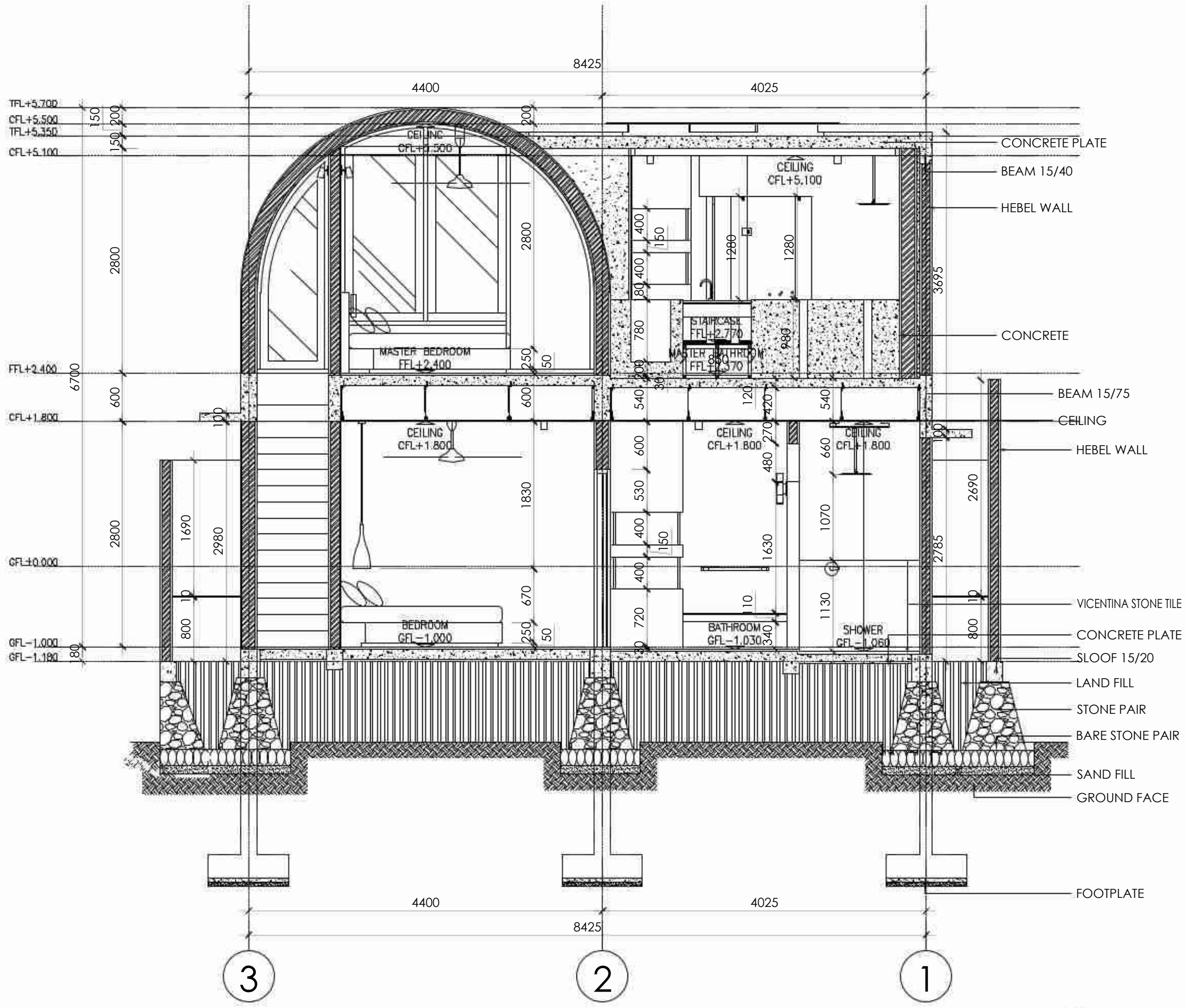

SECTION B-B VILLA B
Scale 1 : 50

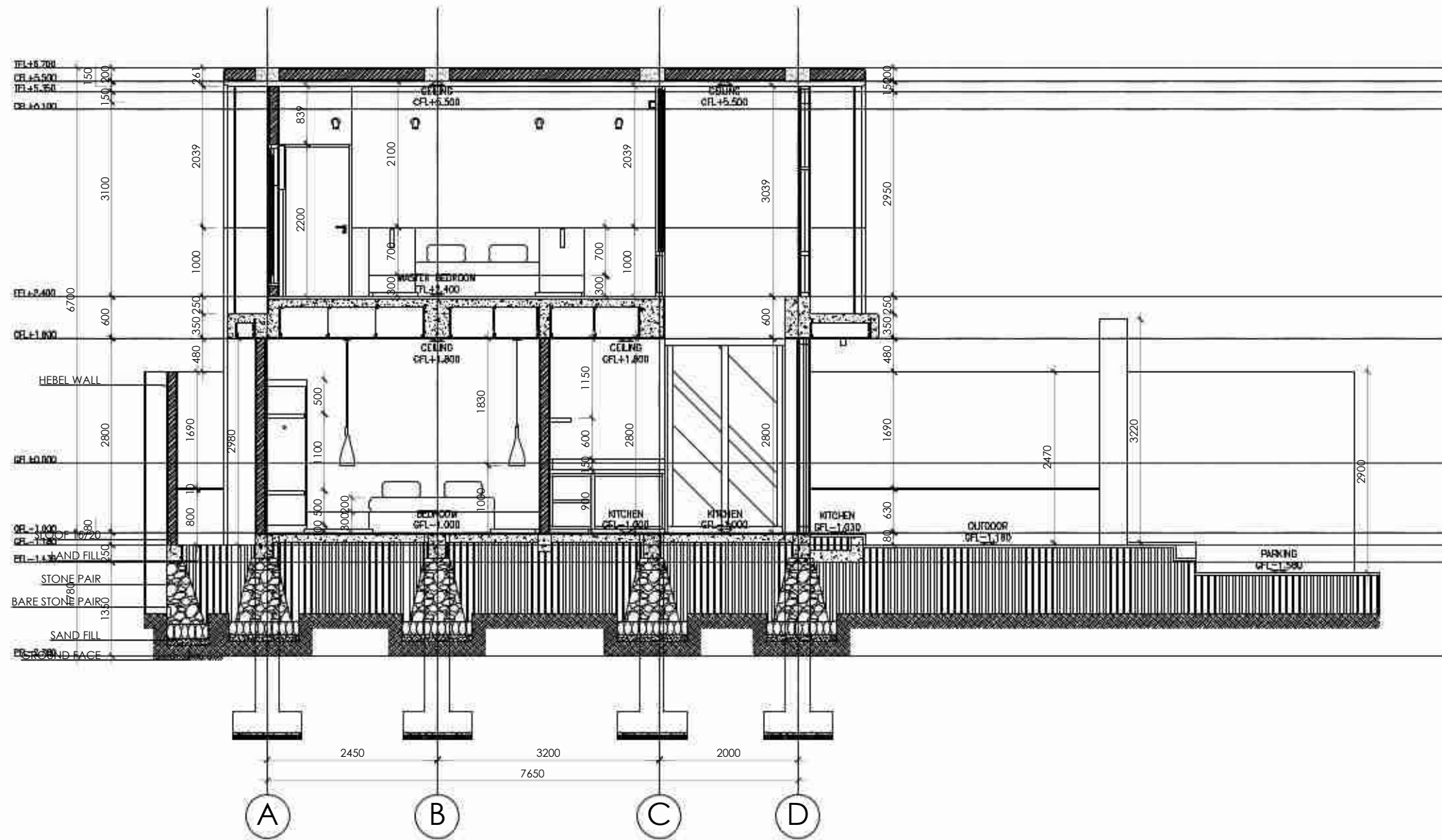

SECTION C-C VILLA B
Scale 1 : 75

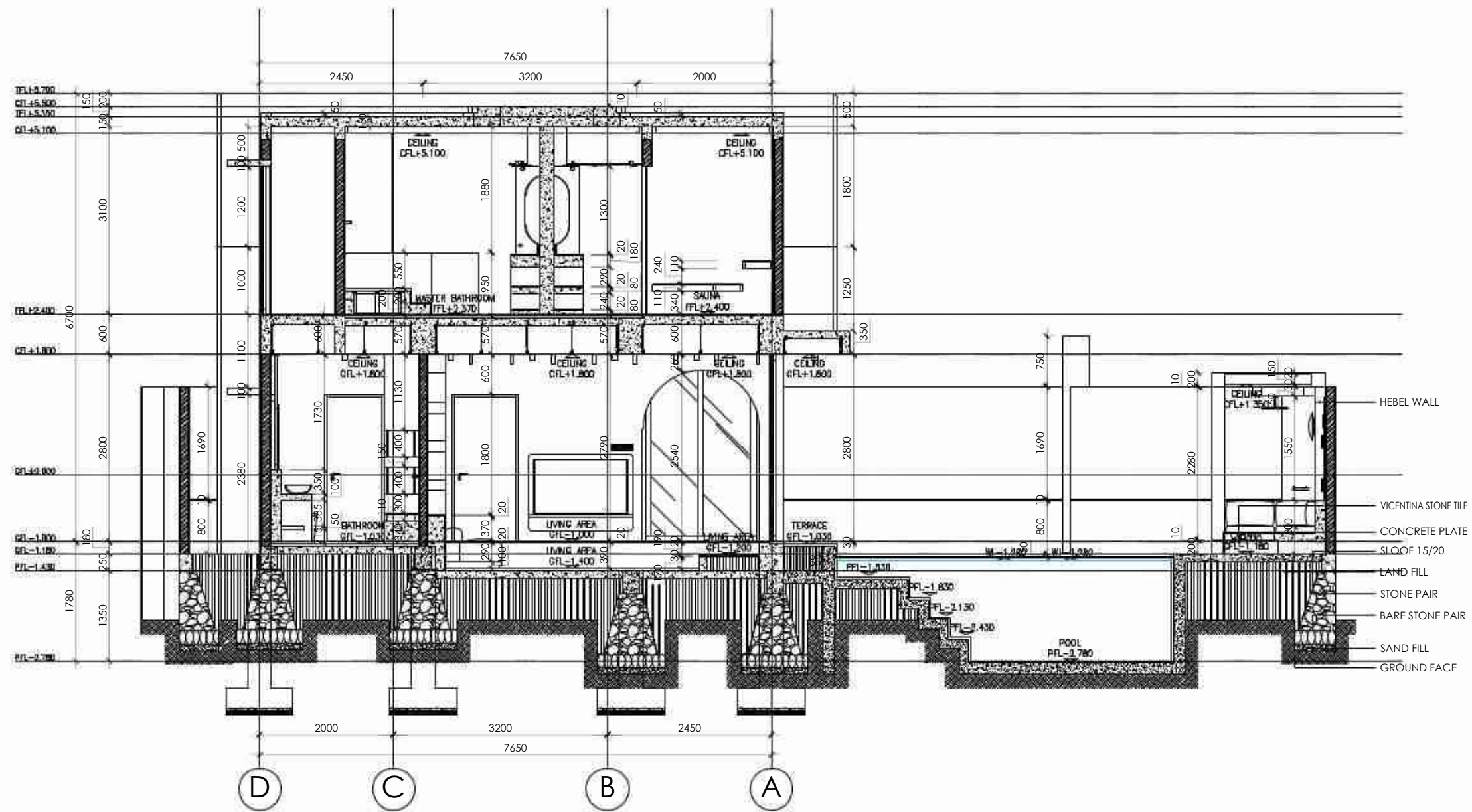

SECTION D-D VILLA B
Scale 1 : 75

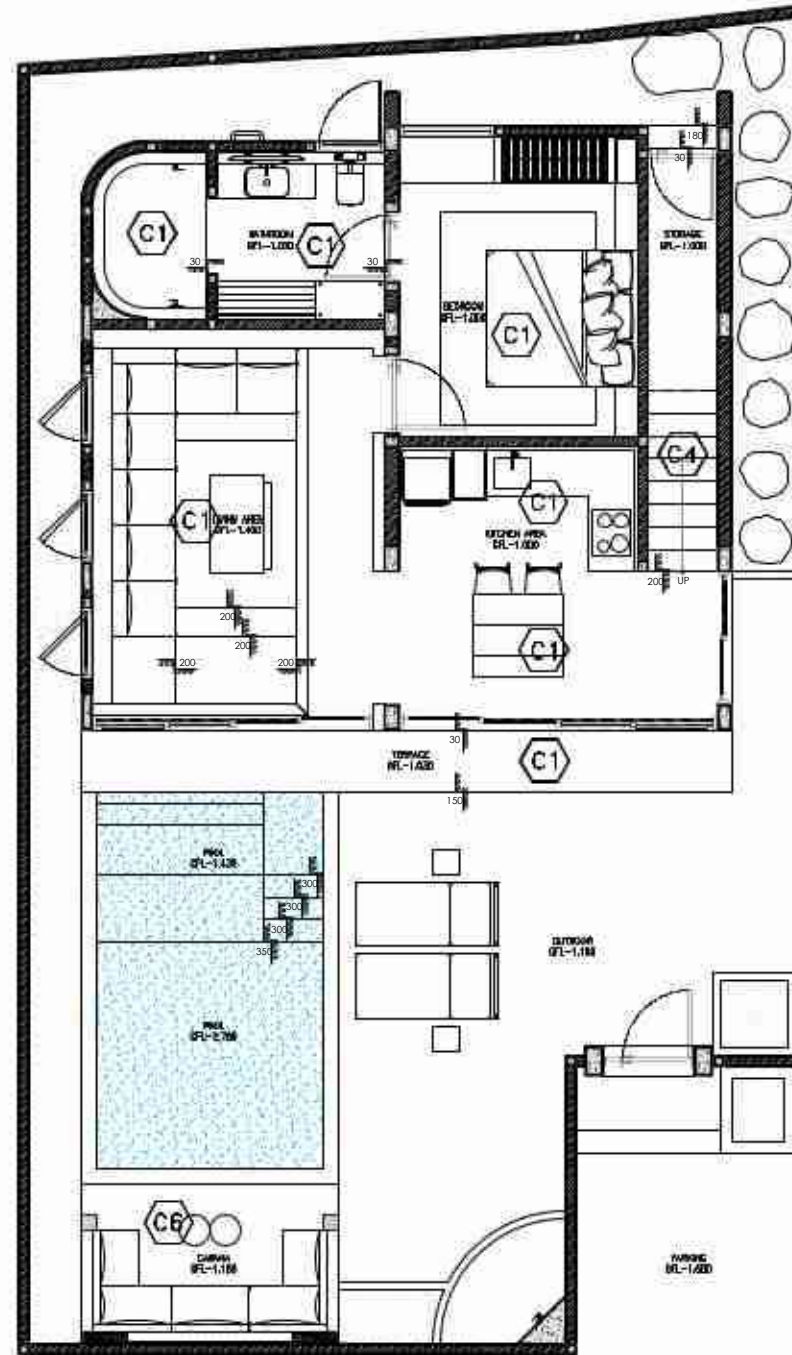

KETERANGAN	
C1	CONCRETE BARE TEXTURE HAZELNUT PAINTING COLOR
C2	MODINO MARBEL TILE
C3	CONCRETE BARE TEXTURE GREY COLOR
C4	CONCRETE BARE TEXTURE PREFER TO MAKE
C5	CONCRETE BARE TEXTURE PREFER TO MAKE
C6	TEAK WOOD FIN BRAK MALIKUT
C7	SPECIAL BRICKS
C8	TERTULON Surface

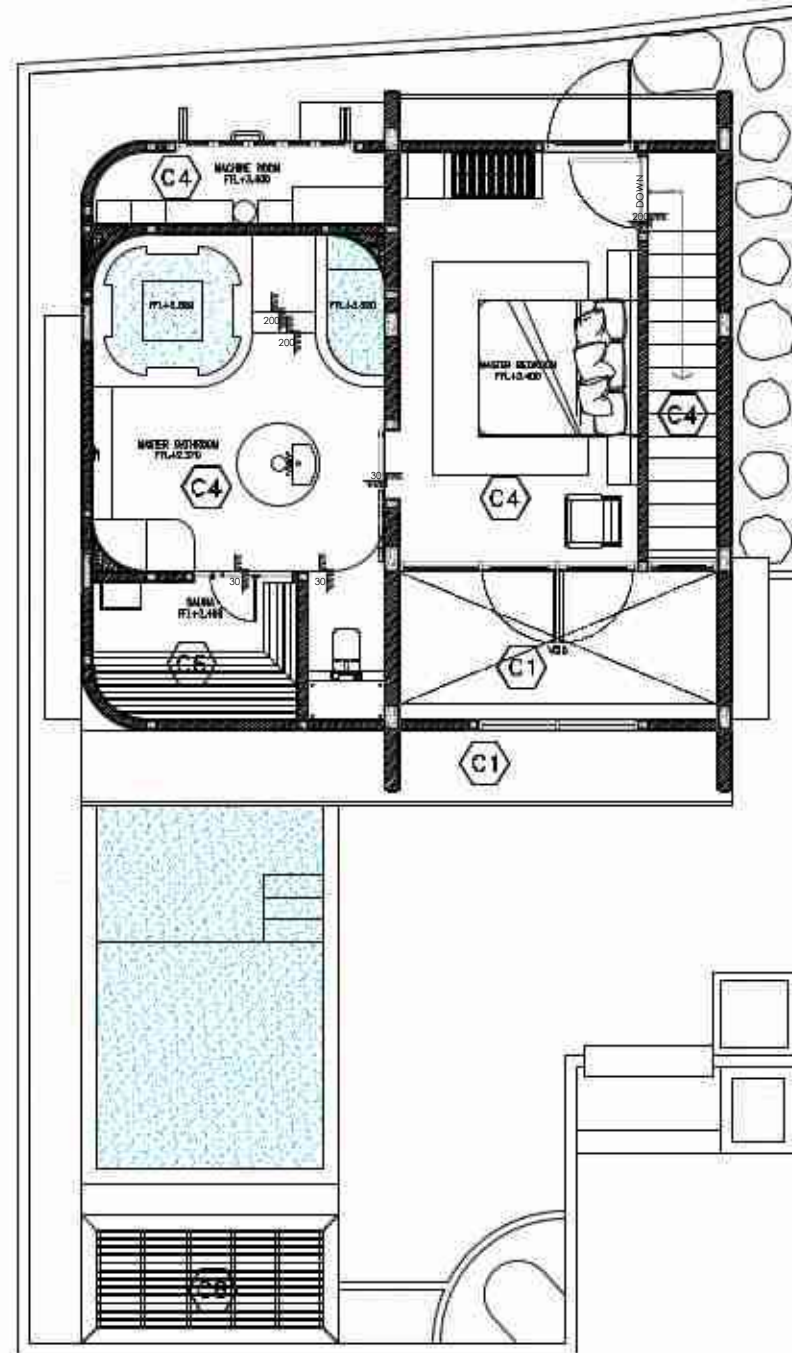

KETERANGAN	
C1	CONCRETE BARE TEXTURE HAZENIT PINKISH COLOR
C2	MOSAIC MARBEL TILE
C3	CONCRETE BARE TEXTURE GREY COLOR
C4	CONCRETE BARE TEXTURE PROFER TO INAGE
C5	CONCRETE BARE TEXTURE PROFER TO INAGE
C6	TEAK 1000 IN DARK VARNISH
C7	SPECIAL IRONS
C8	Terrazzo Surface

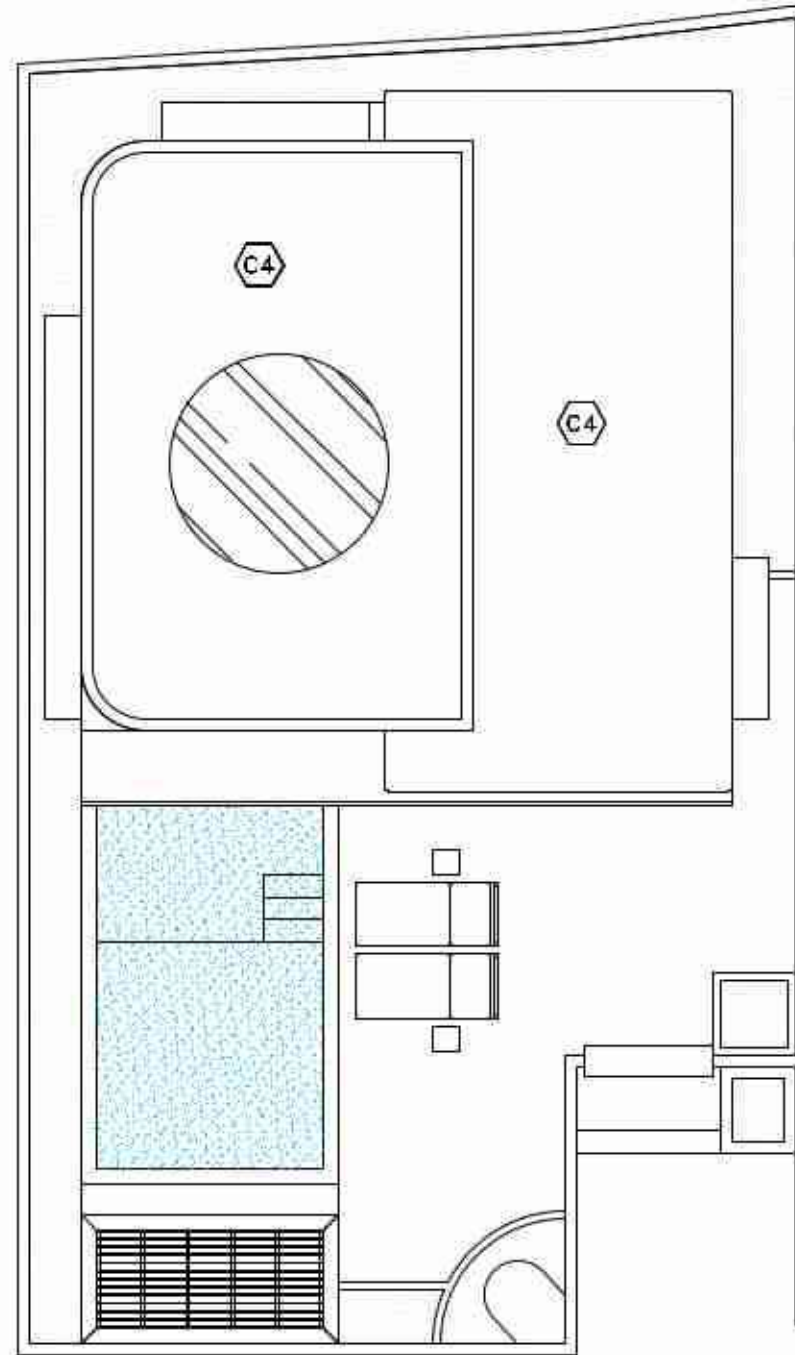

KETERANGAN	
(C1)	CONCRETE BARE TEXTURE HAZENIT PINKISH COLOR
(C2)	MOSAIC MARBLE TILE
(C3)	CONCRETE BARE TEXTURE GREY COLOR
(C4)	CONCRETE BARE TEXTURE PROFER TO INAGE
(C5)	CONCRETE BARE TEXTURE PROFER TO INAGE
(C6)	TEAK 1000 IN DARK WASHED
(C7)	SPECIAL IRONS
(C8)	Terrazzo Surface

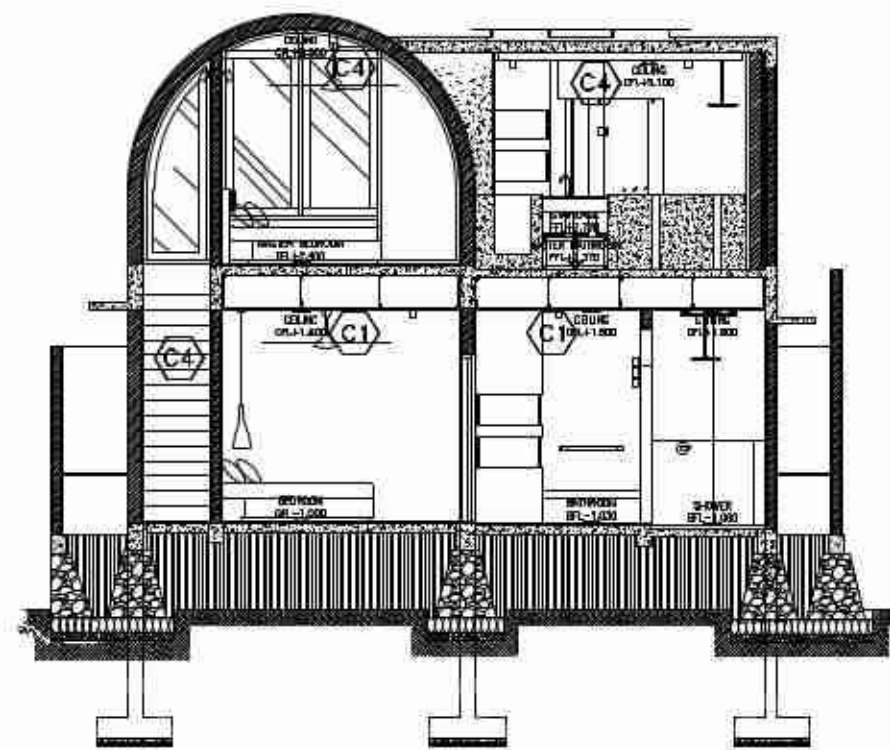
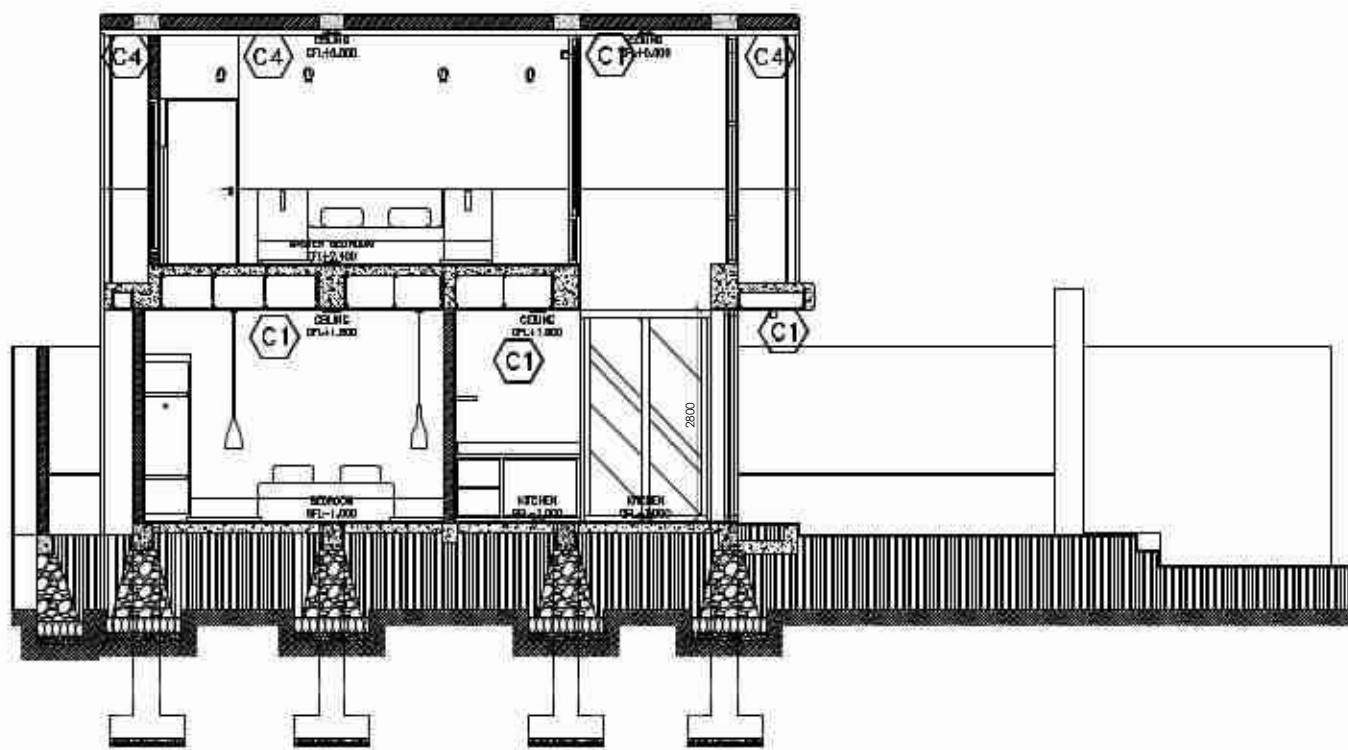
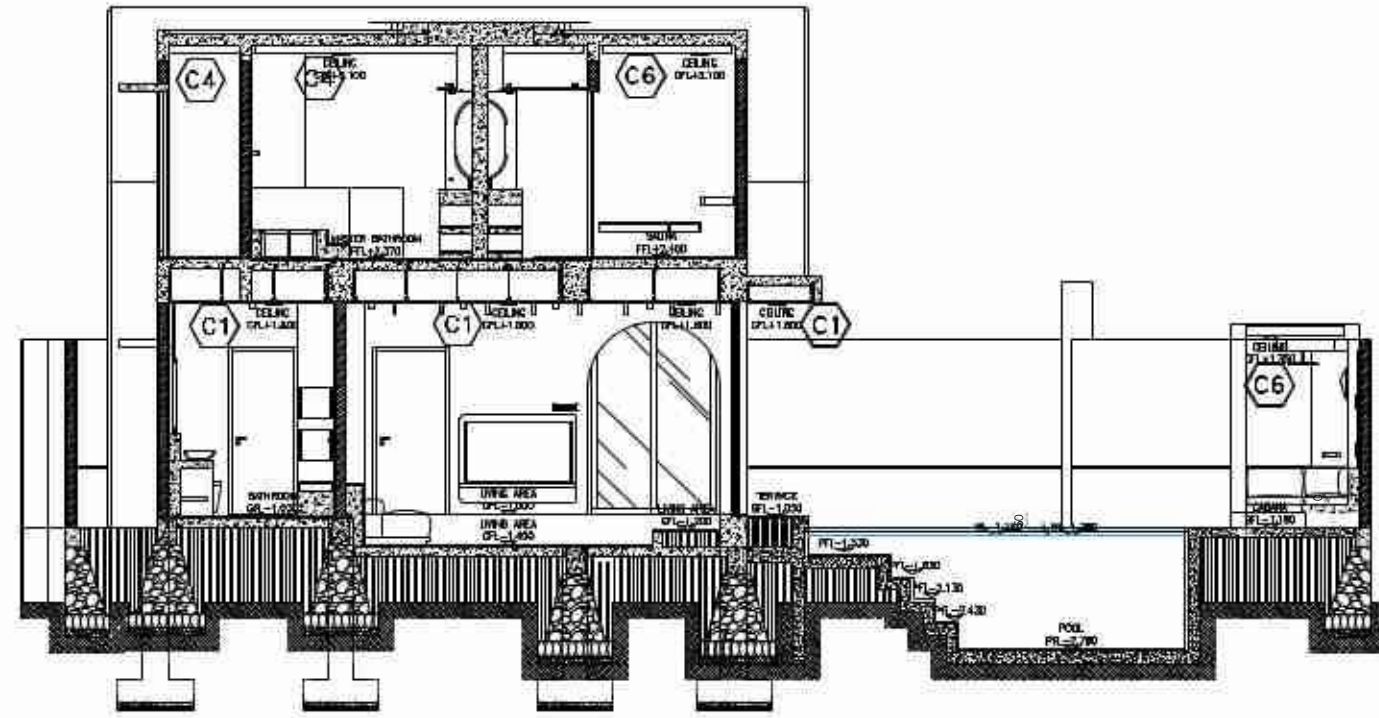
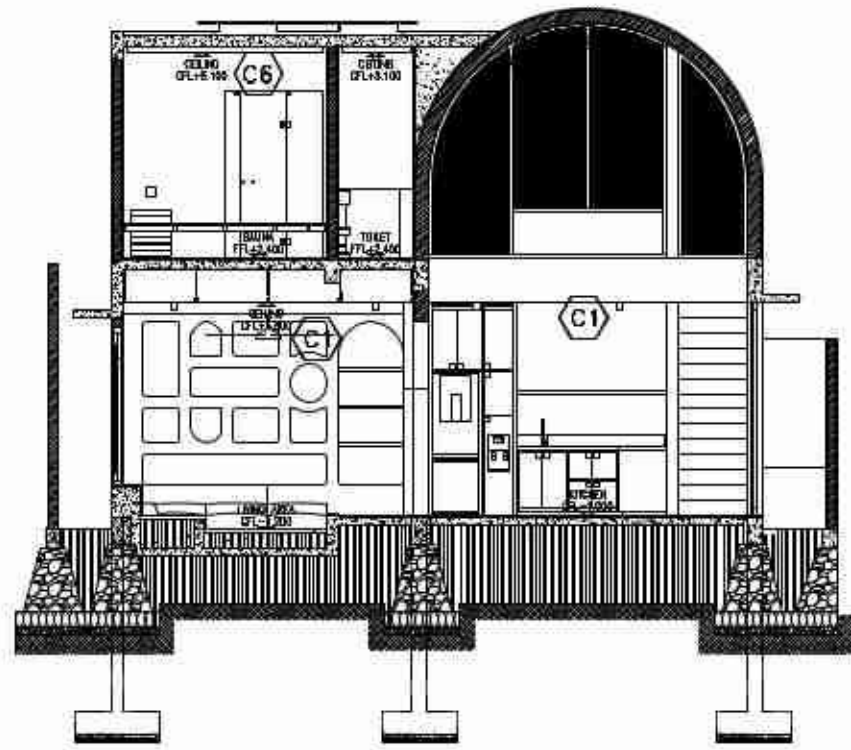

KETERANGAN	
(C1)	CONCRETE BARE TEXTURE HAZARDAT PANTONE COLOR
(C2)	MISKIN MARBEL TILE
(C3)	CONCRETE BARE TEXTURE GREY GILOR
(C4)	CONCRETE BARE TEXTURE PREFER TO IMAGE
(C5)	CONCRETE BARE TEXTURE PREFER TO IMAGE
(C6)	TEAK WOOD FIN DARK WAKAT
(C7)	SPECIAL FINISH
(C8)	TERRAZZO SURFACE

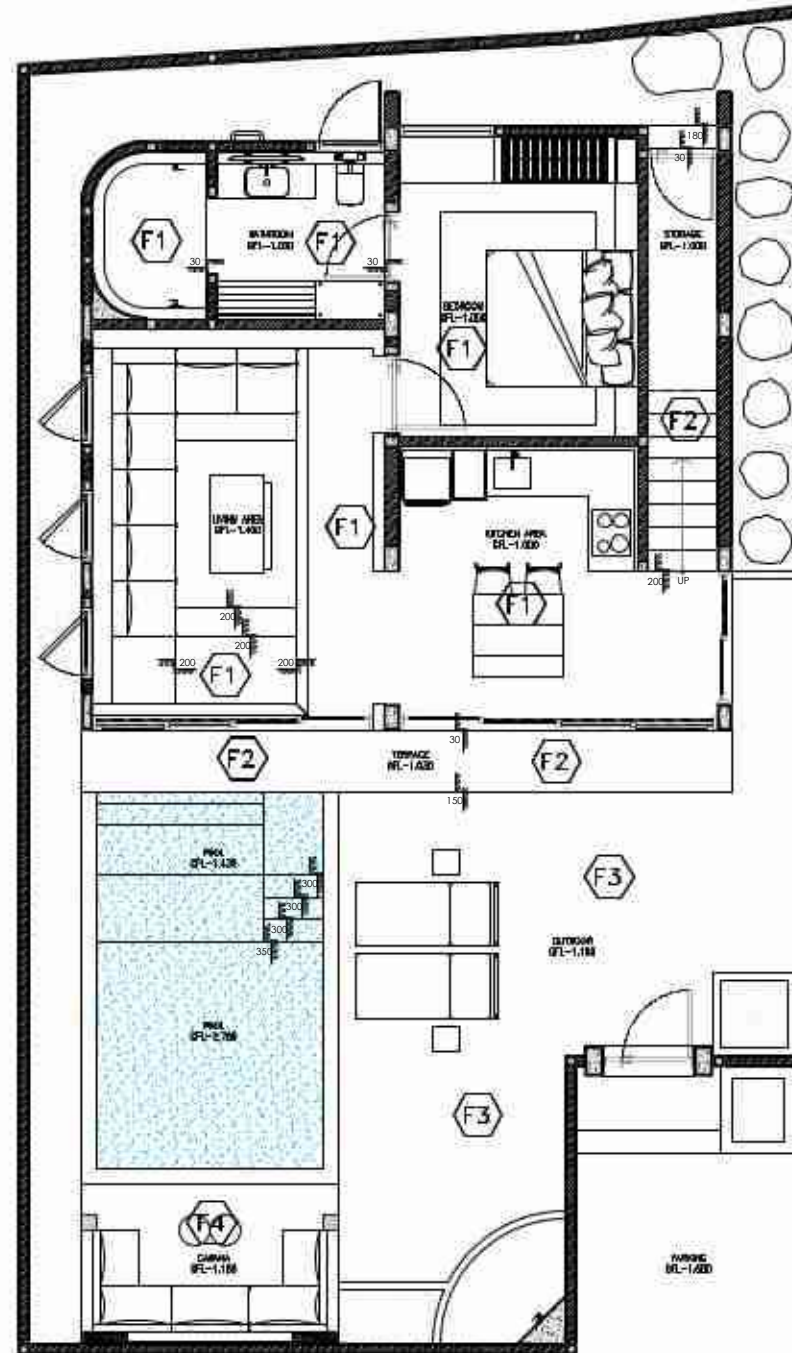

KETERANGAN	
F1	VICENZA STONE TILE
F2	SPECIAL BRICKS
F3	PURPURA PAVING COBBLESTONE
F4	CONCRETE BASE TEXTURE GREY COLOR
F5	TEAM WOOD FIN DARK WALNUT

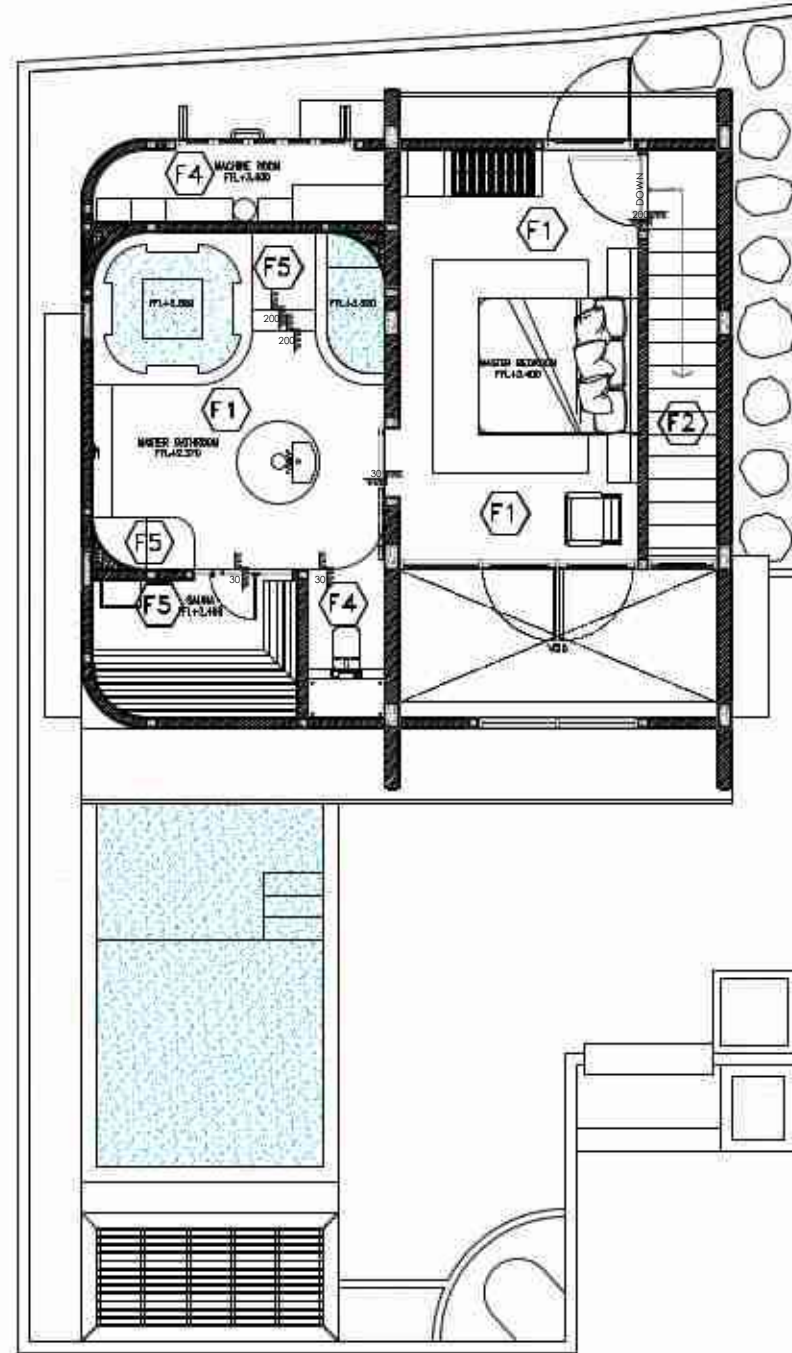

KETERANGAN	
F1	VICENTINA STONE TILE
F2	SPECIAL BRICKS
F3	PURIFIED PAVING COBBLESTONE
F4	CONCRETE BASE TEXTURE GREY COLOR
F5	TEAK WOOD FINISH WALKOUT

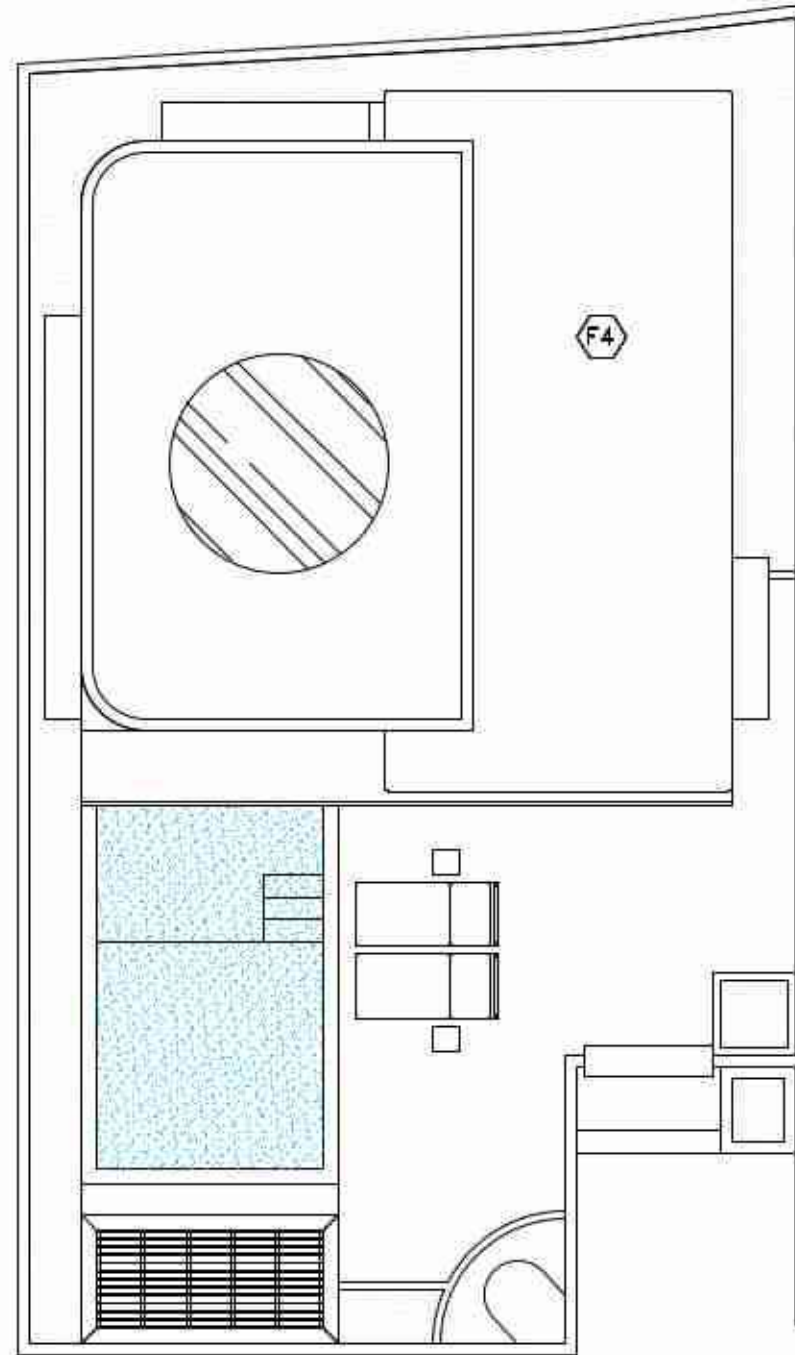

KETERANGAN	
(F1)	VICENTINA STONE TILE
(F2)	SPECIAL BRICKS
(F3)	PURIFIED PAVING COBBLESTONE
(F4)	CONCRETE BASE TEXTURE GREY COLOR
(F5)	TEPAK BERSI FIN DRAIN PALANG

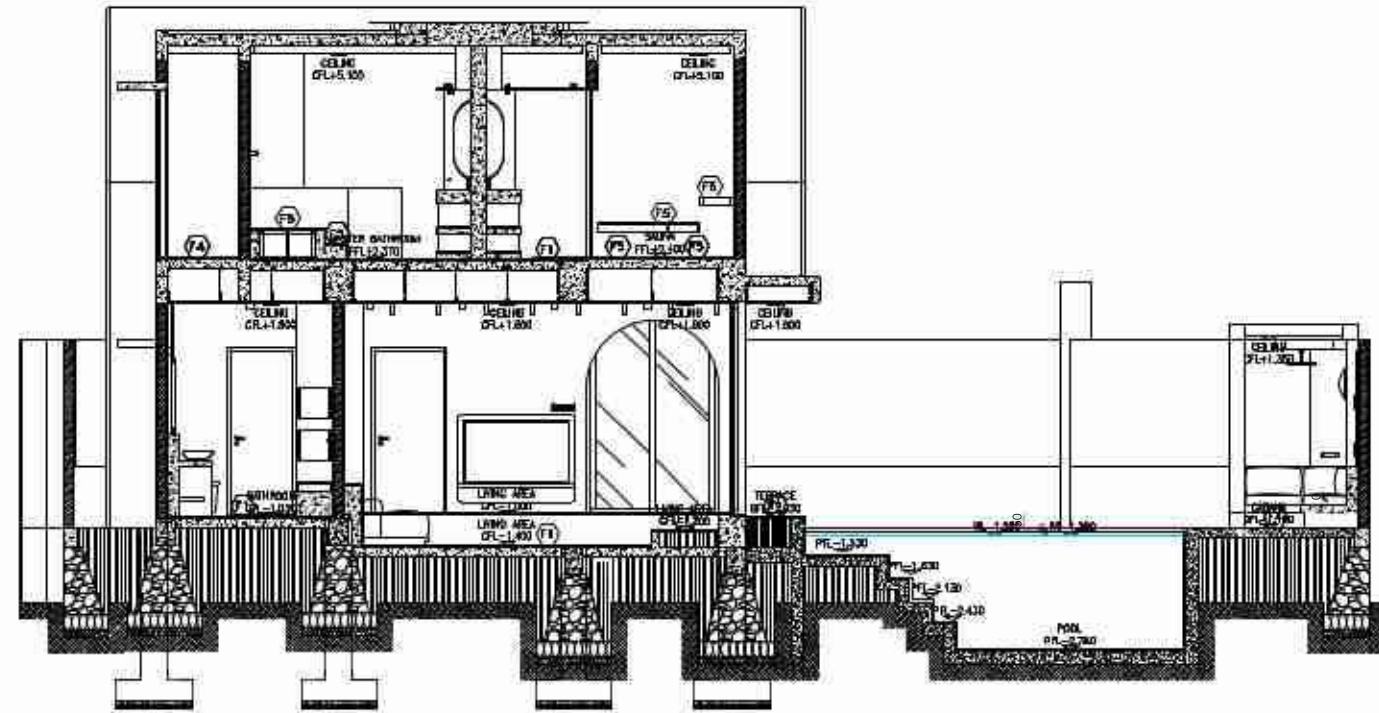
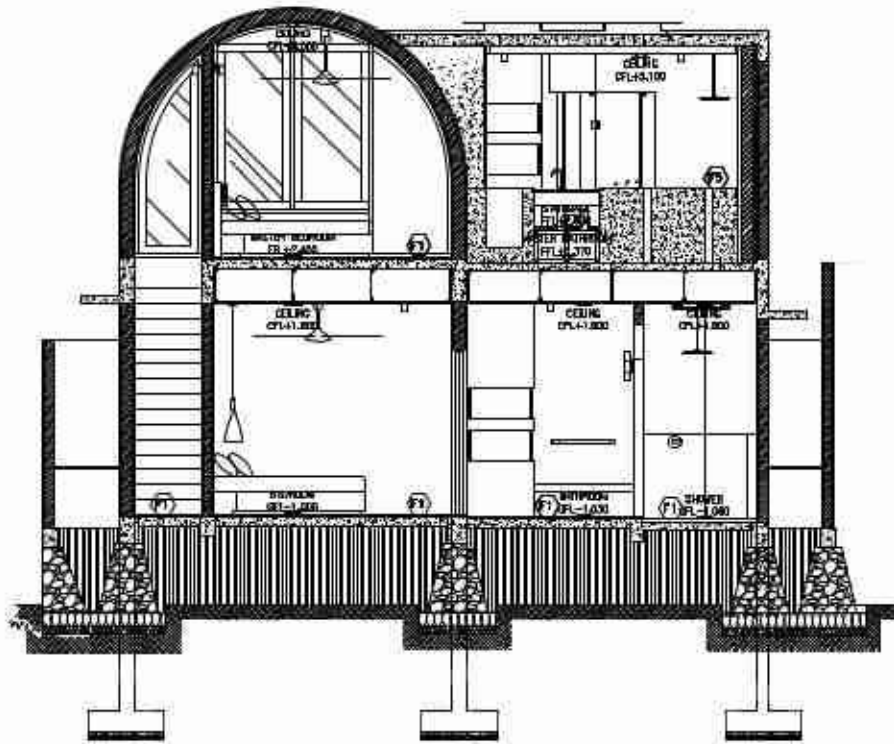
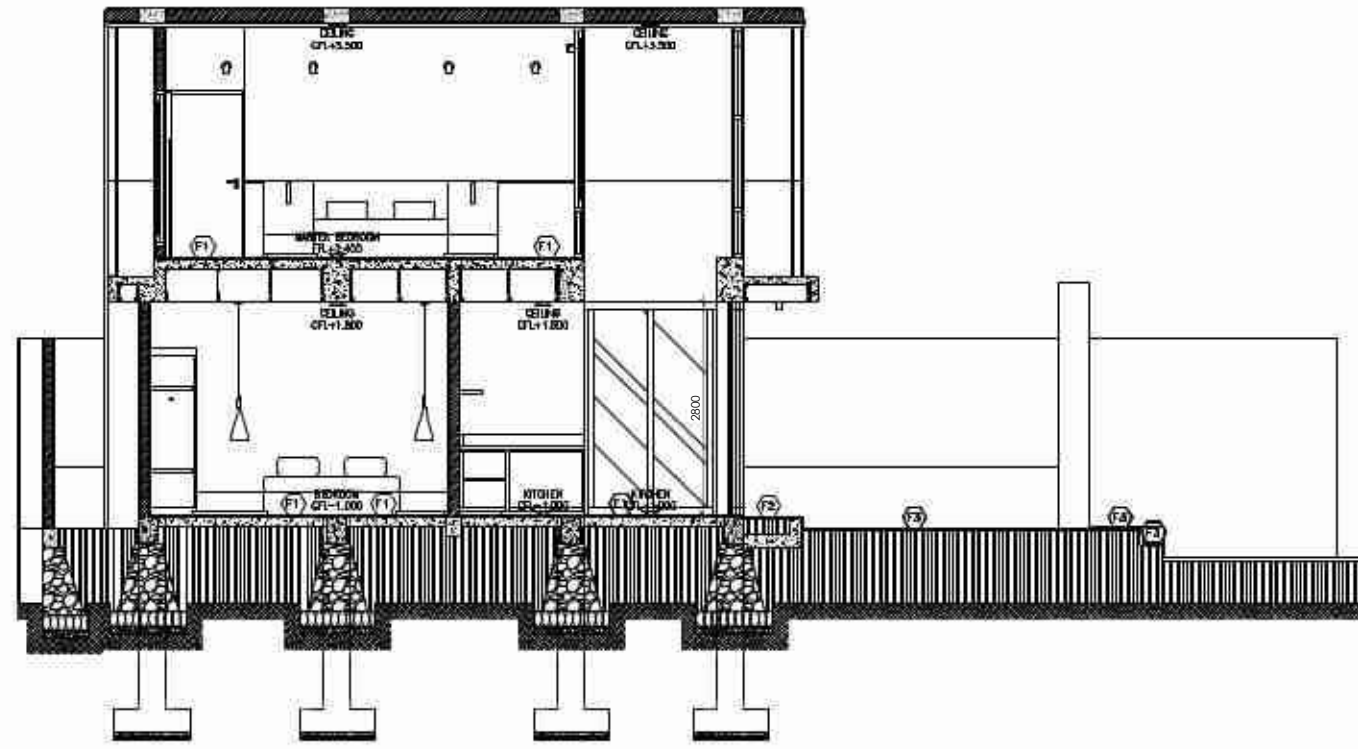
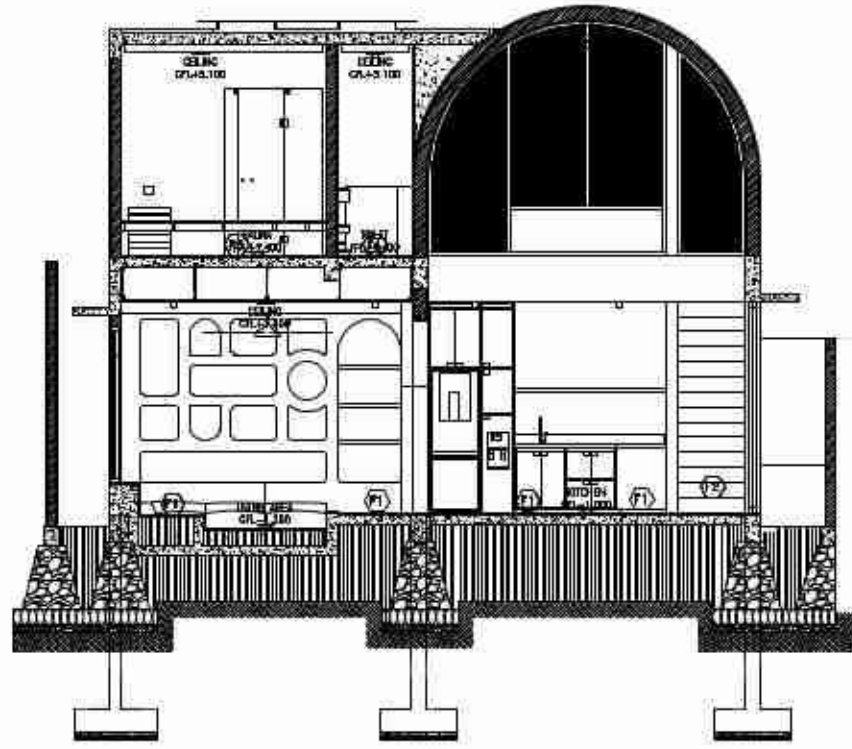

KETERANGAN	
(F1)	VICENTINA STONE TILE
(F2)	SPECIAL BRICKS
(F3)	PORFIDO PAVING COBBLESTONE
(F4)	CONCRETE BARE TEXTURE GREY COLOR
(F5)	TEAK WOOD FIN. DRINK WALIAT

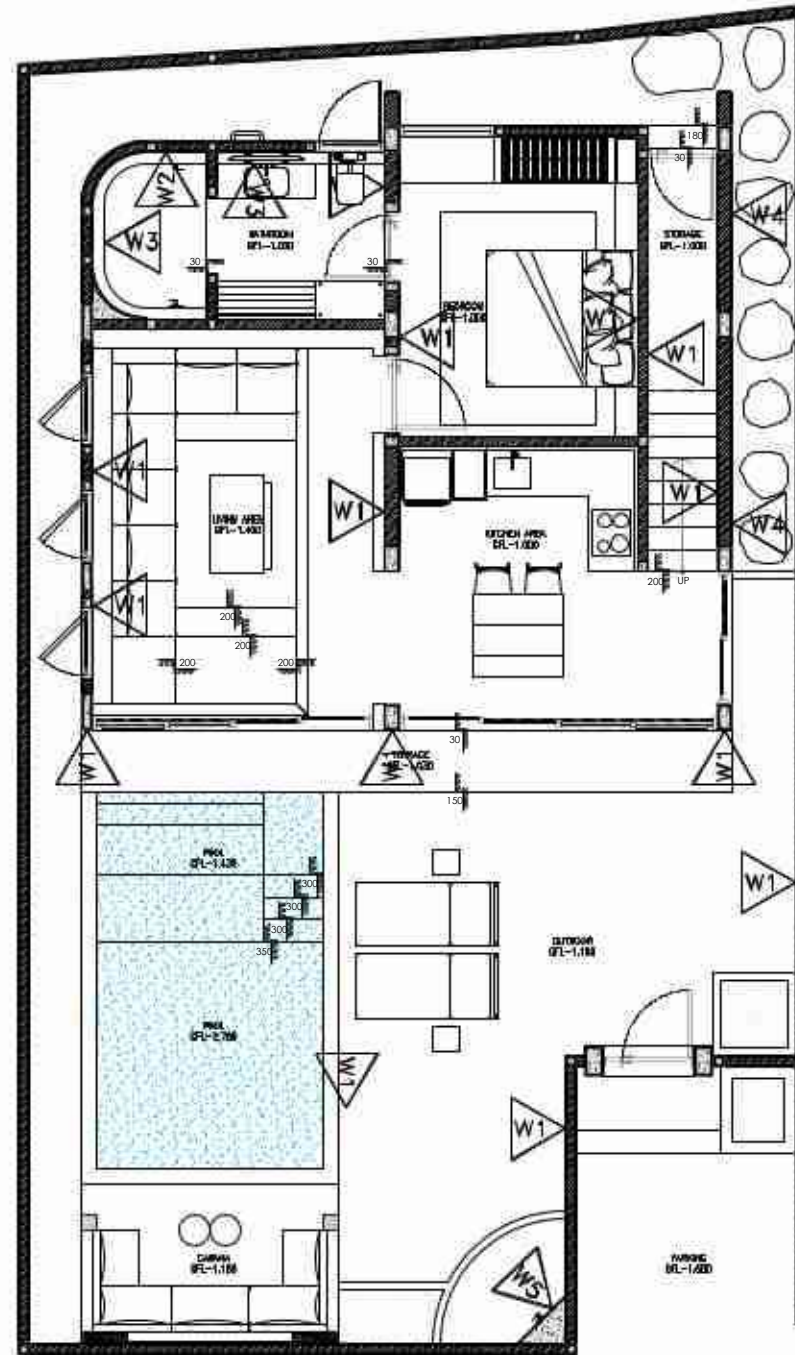

KETERANGAN	
W1	CONCRETE BARE TEXTURE HAZELHIT MATIOME COLOR
W2	HORIZONTAL MARBEL TILE
W3	CONCRETE BARE TEXTURE GREY COLOR
W4	CONCRETE BARE TEXTURE PREFER TO MARBLE
W5	CONCRETE BARE TEXTURE PREFER TO MARBLE
W6	TEAK MOOD FIN OFFER VULKUIT
W7	SPECIAL BRICKS

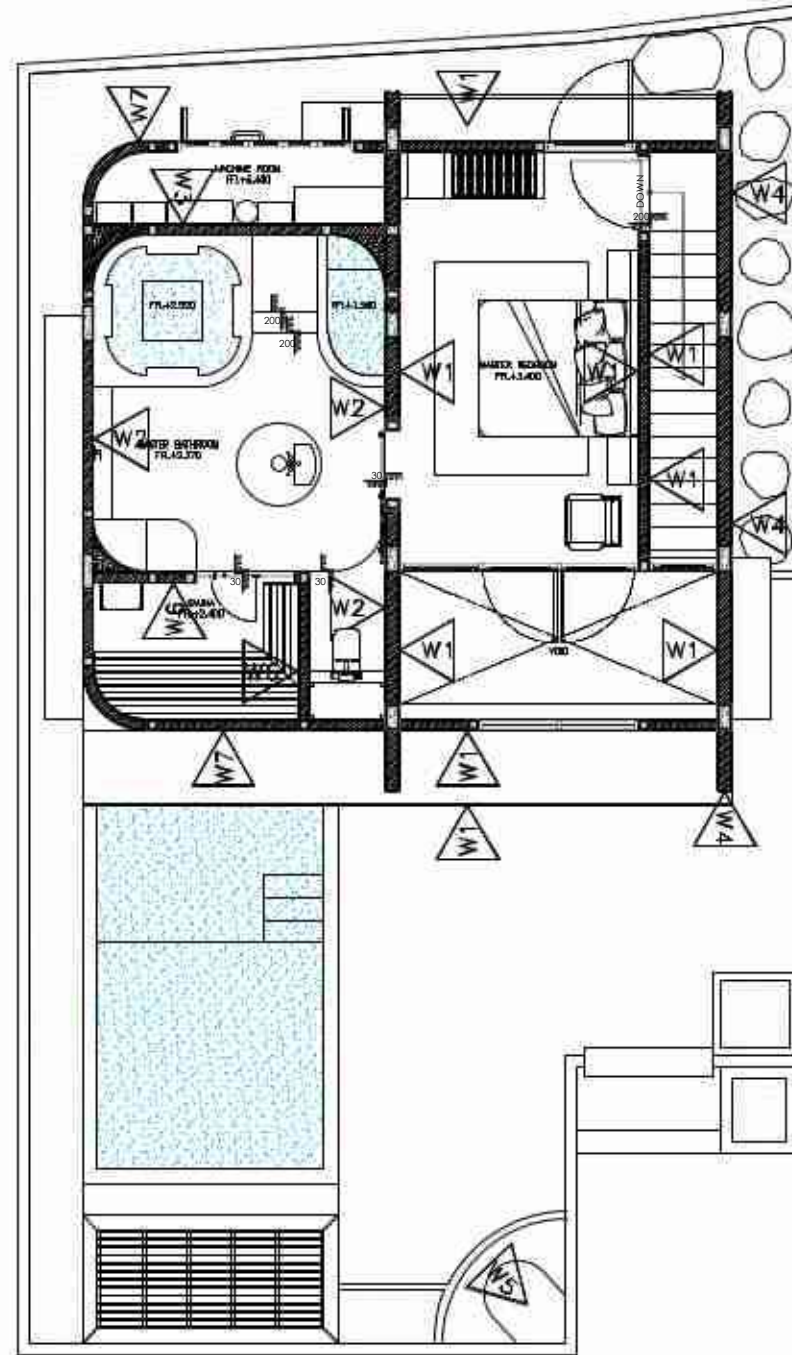

KETERANGAN	
W1	CONCRETE BARE TEXTURE HAZELHUT PANTONE COLOR
W2	HORIZONTAL MARBLE TILE
W3	CONCRETE BARE TEXTURE GREY COLOR
W4	CONCRETE BARE TEXTURE PREFER TO BRICK
W5	CONCRETE BARE TEXTURE PREFER TO BRICK
W6	TEAK WOOD FIN OFFER VULKUIT
W7	SPECIAL BRICKS

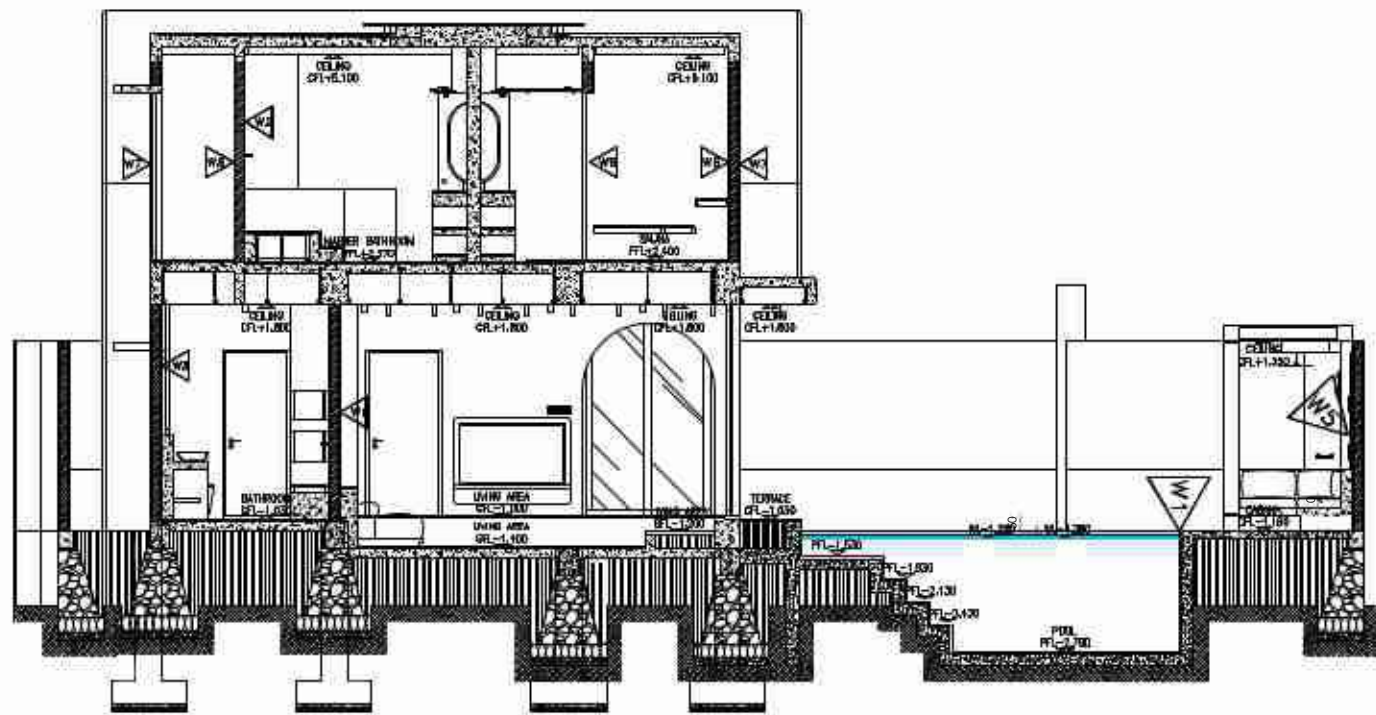
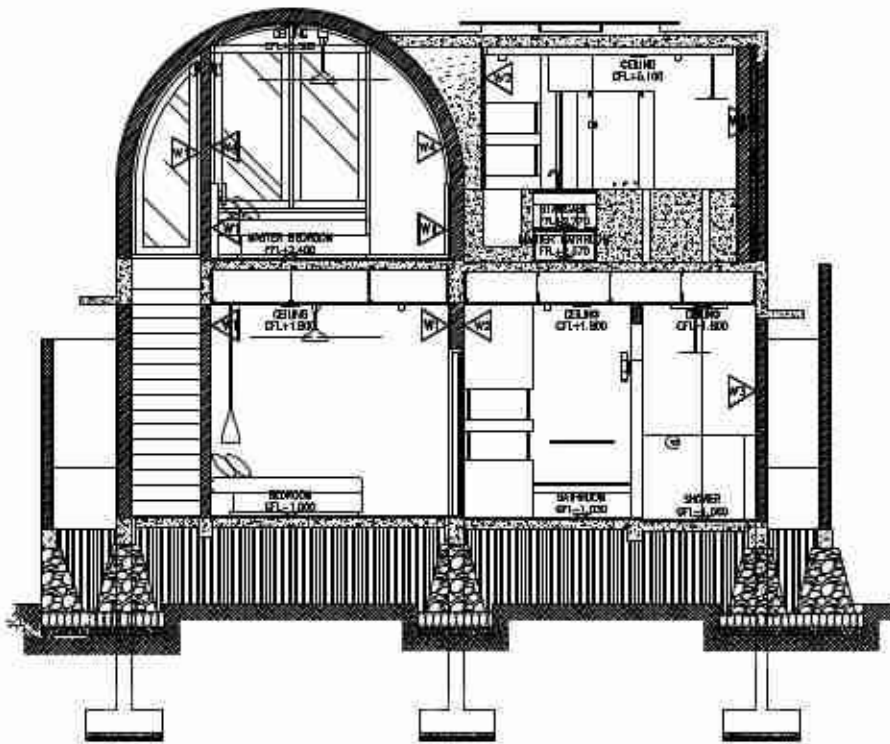
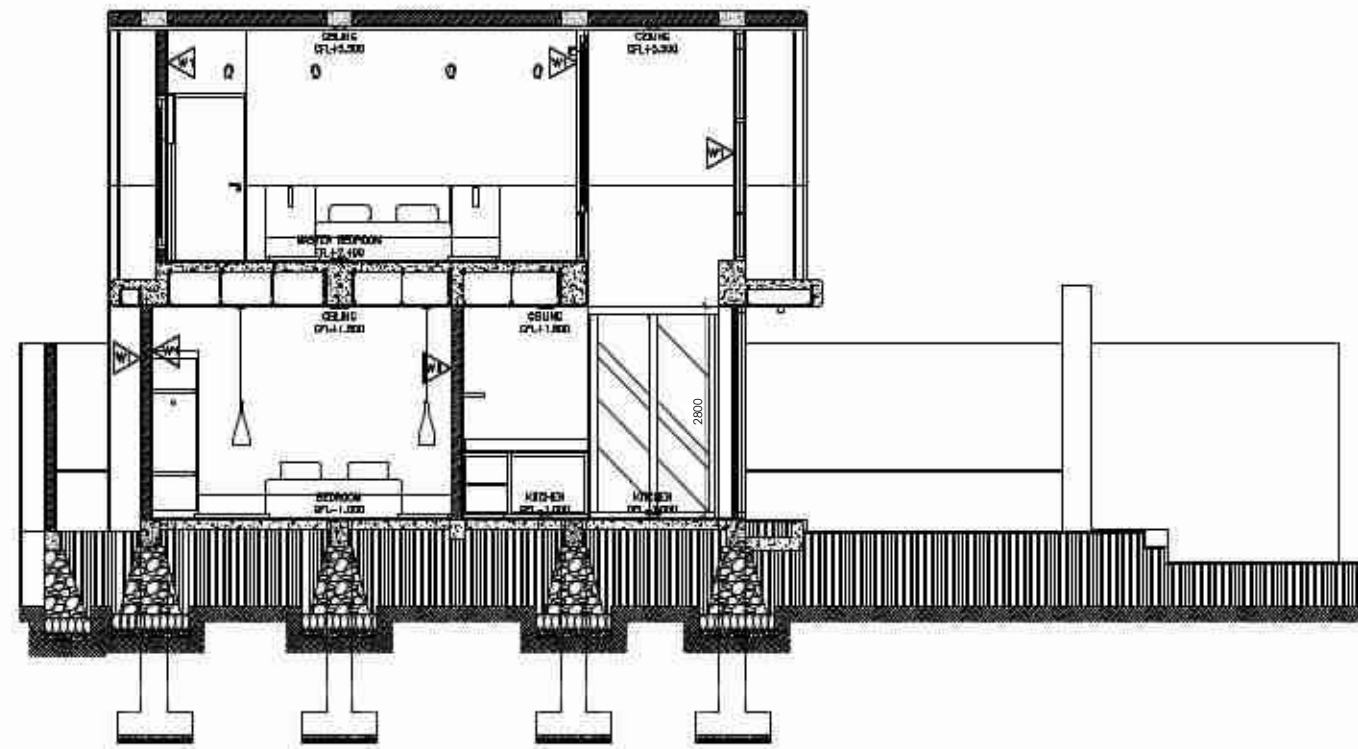
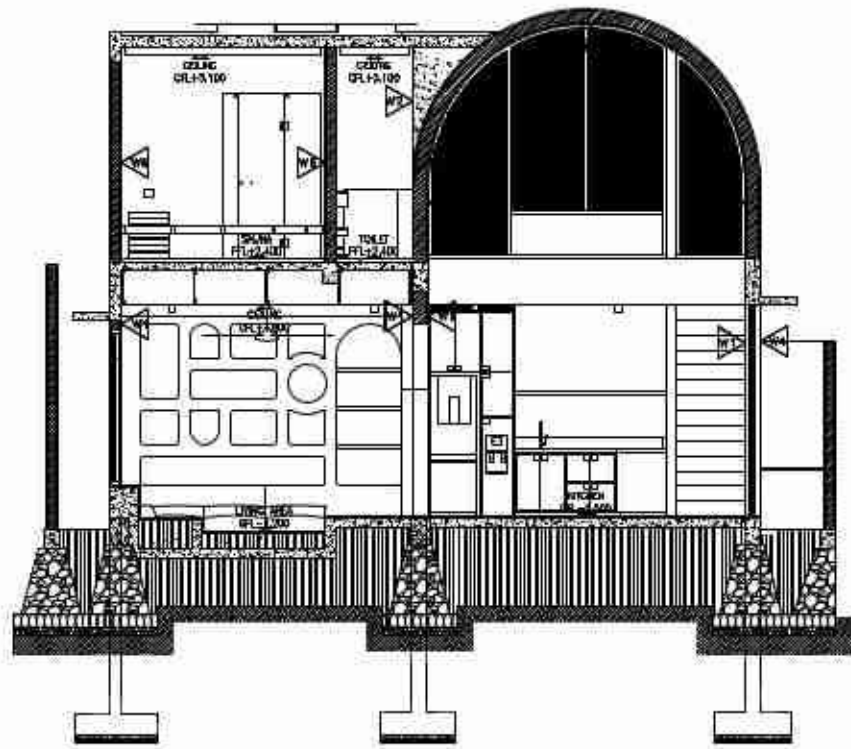

KETERANGAN	
	CONCRETE BASE TEXTURE HAZELINT PARTONE COLOR
	MOSAIK MARBEL TILC
	CONCRETE BASE TEXTURE GREY COLOR
	CONCRETE BASE TEXTURE PREFER TO IMAGE
	CONCRETE BASE TEXTURE PREFER TO IMAGE
	TEAK WOOD PIN DARK NUHANT
	SPECIAL BRICKS

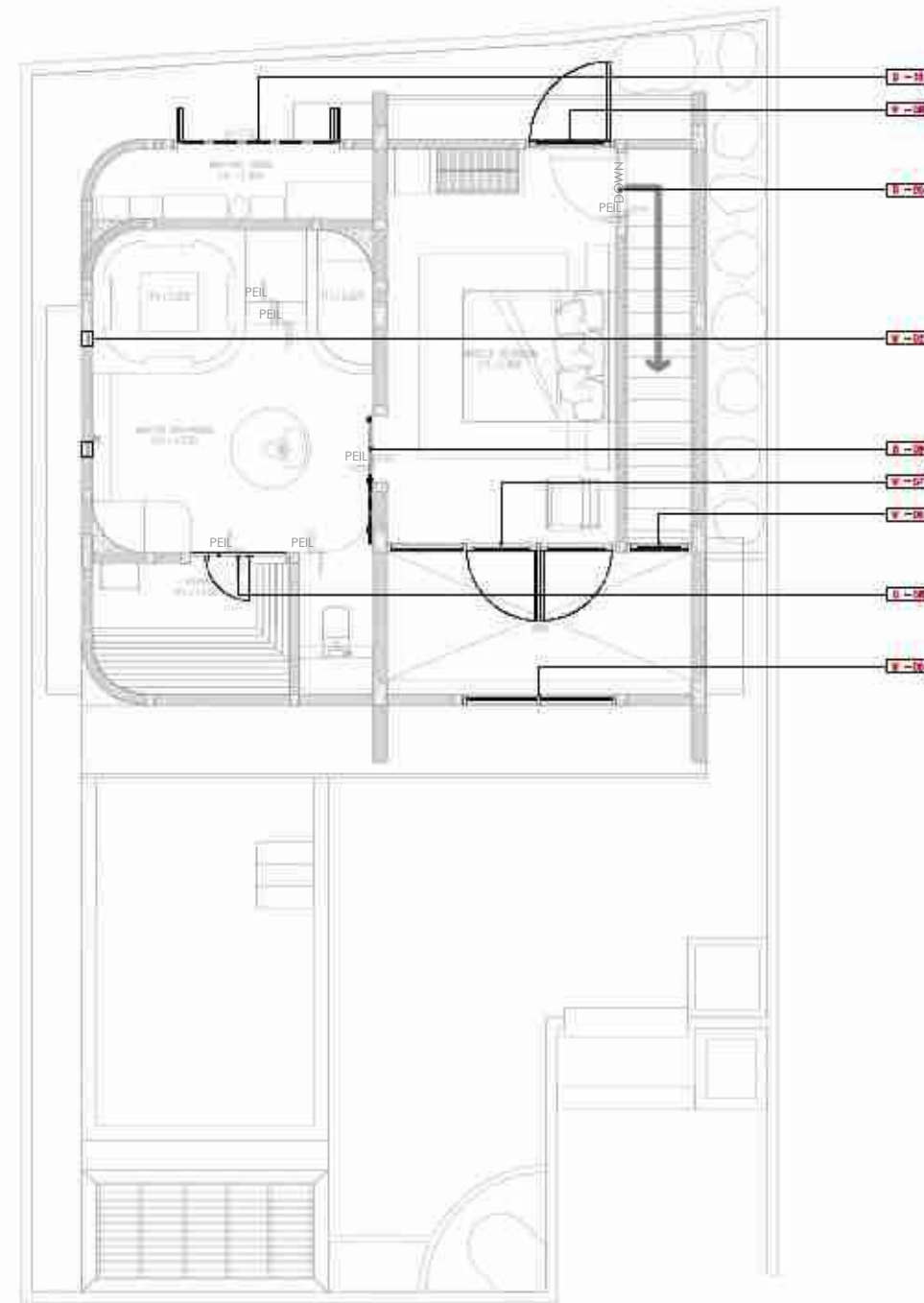
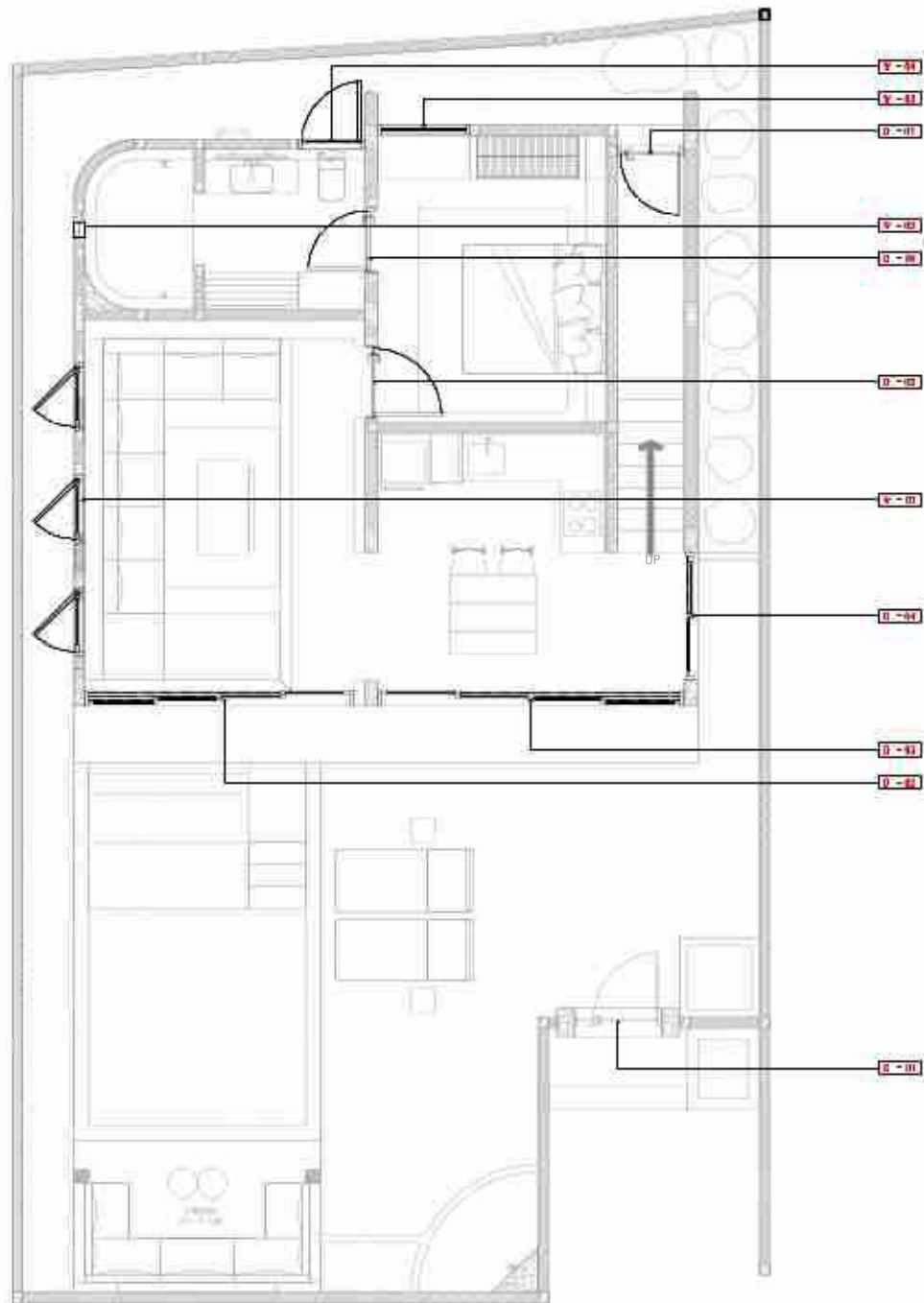

DOOR AND WINDOW PLAN VILLA B
Scale 1 : 100

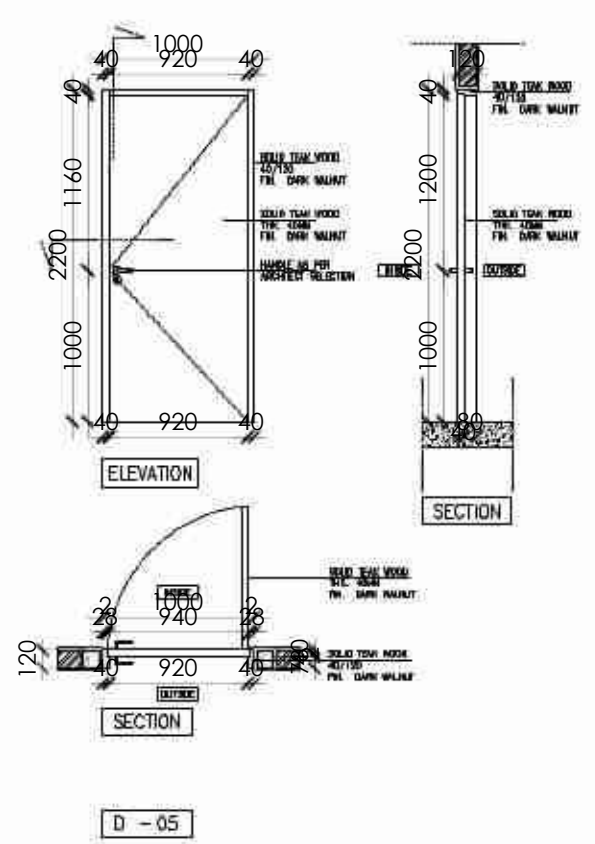
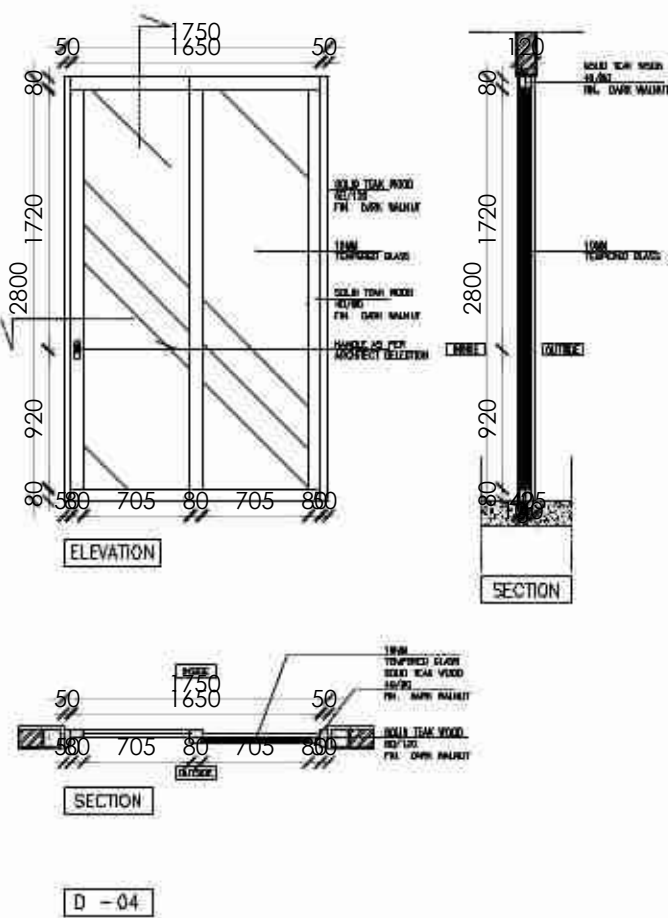
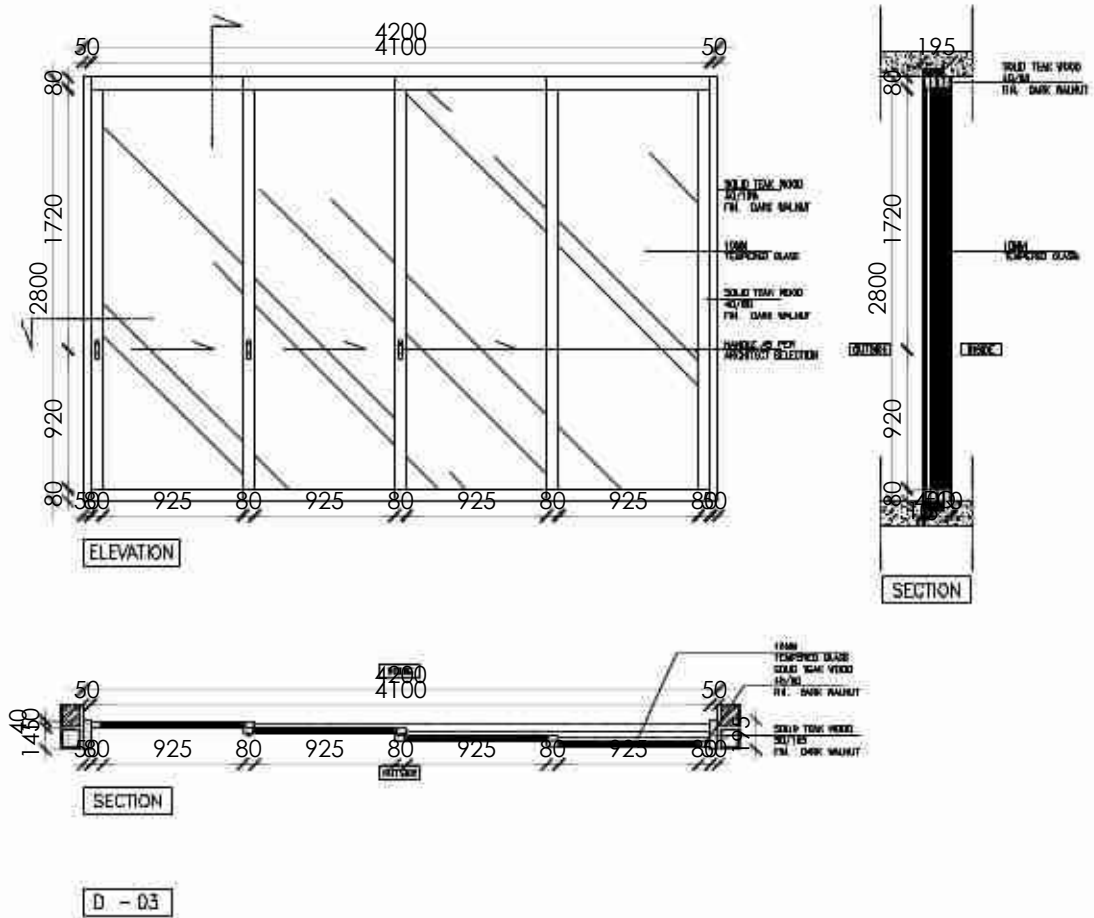
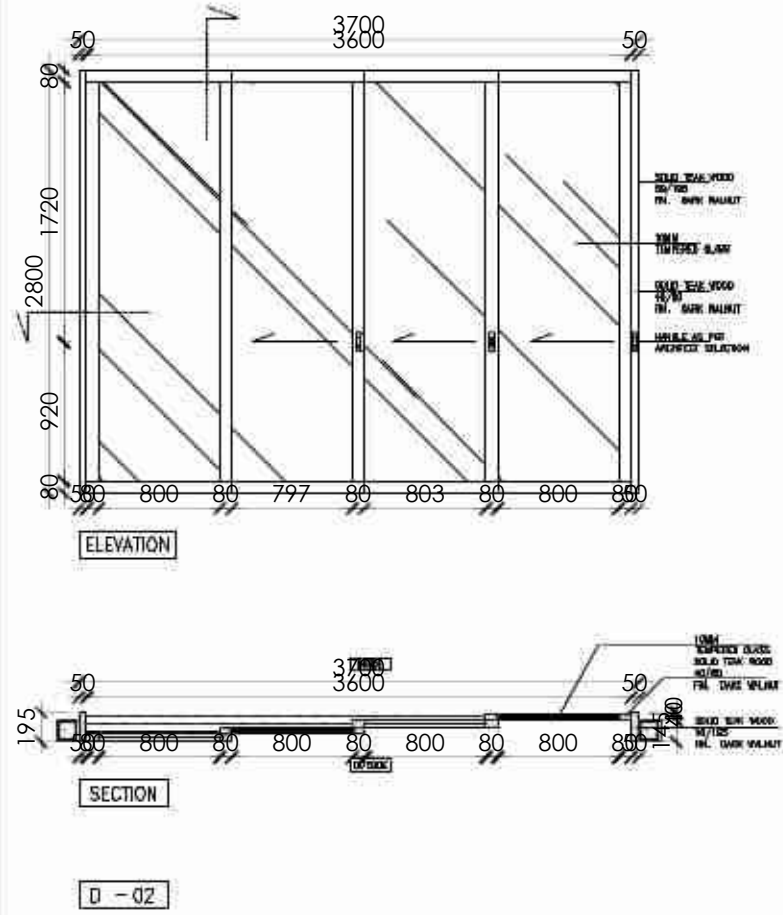
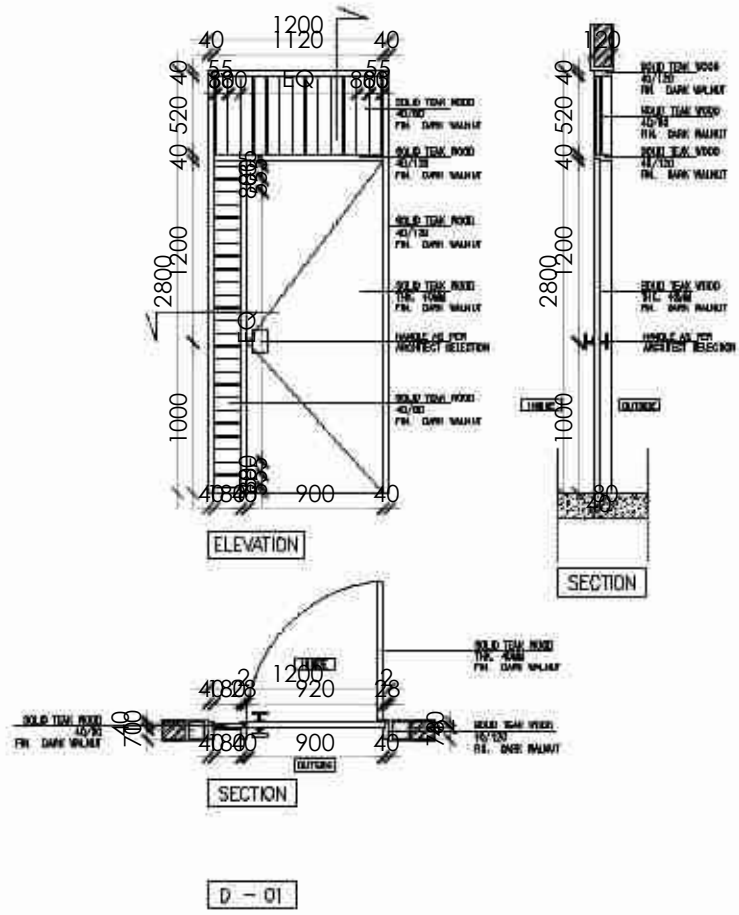

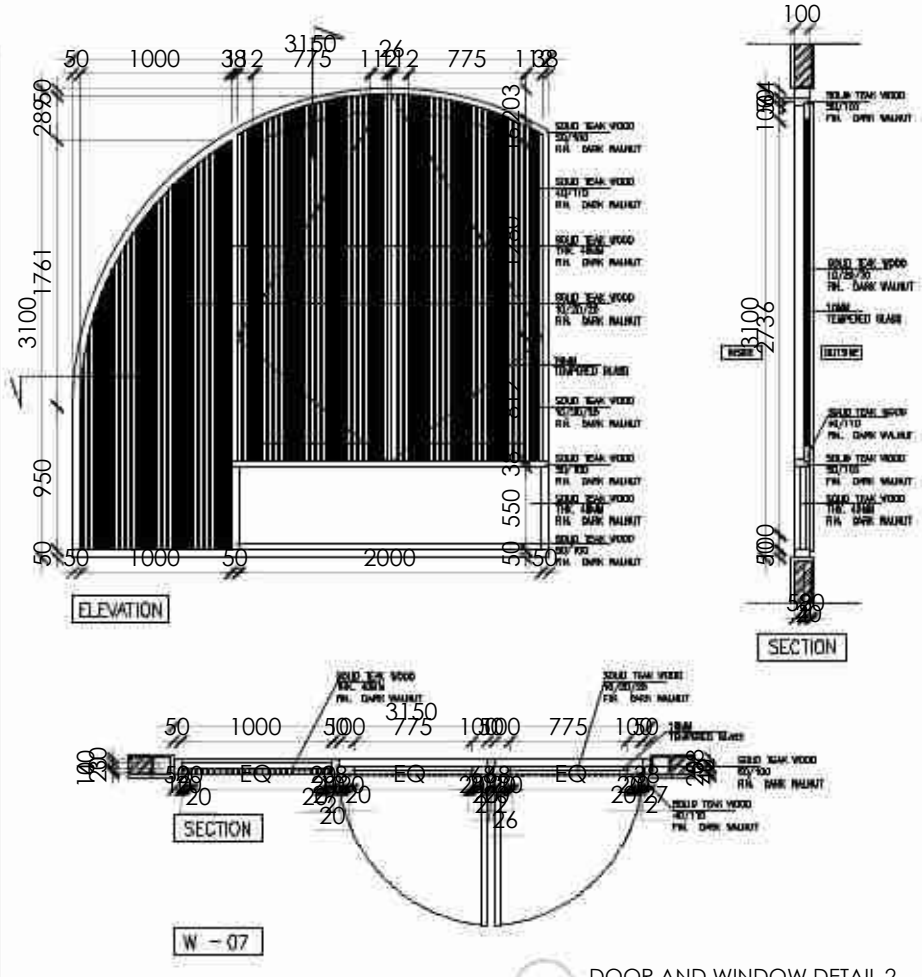
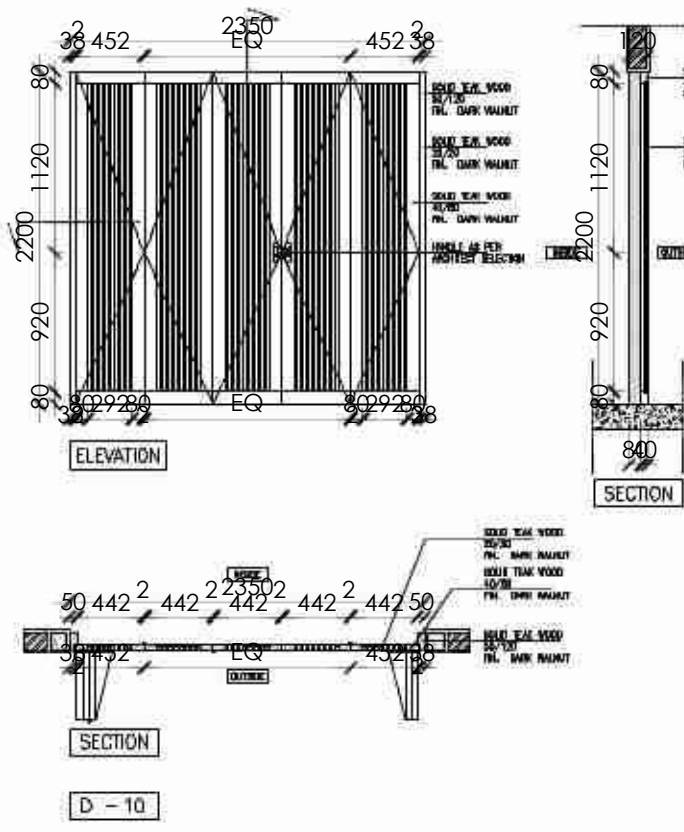
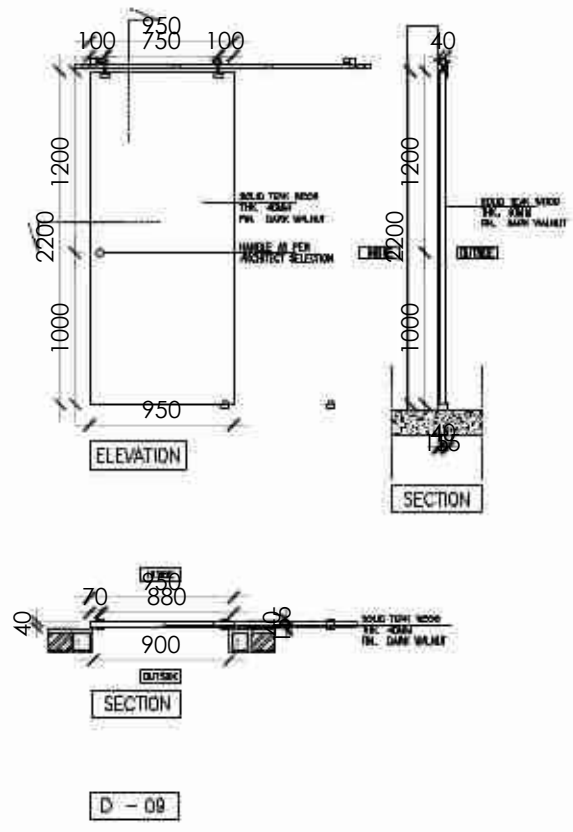
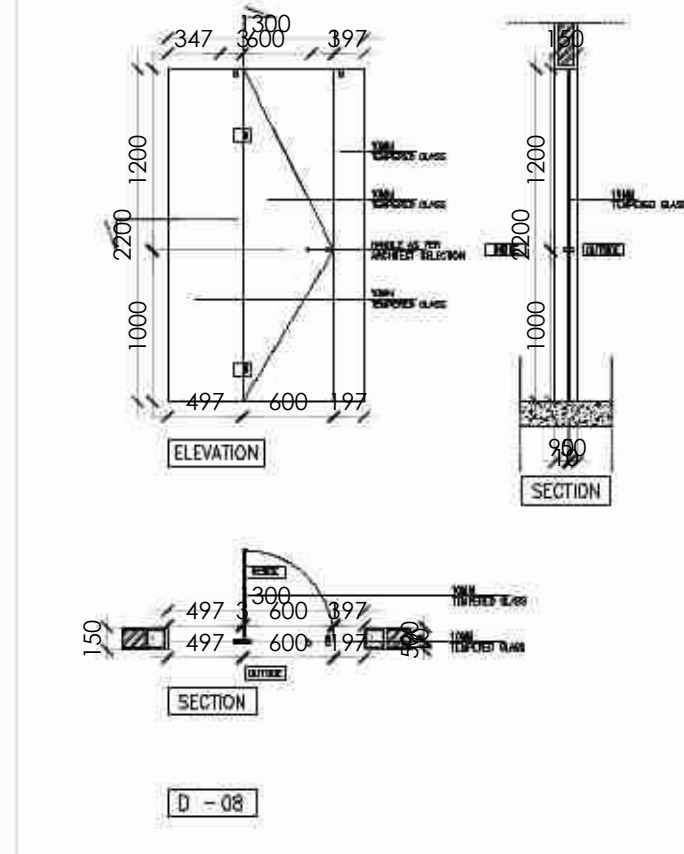
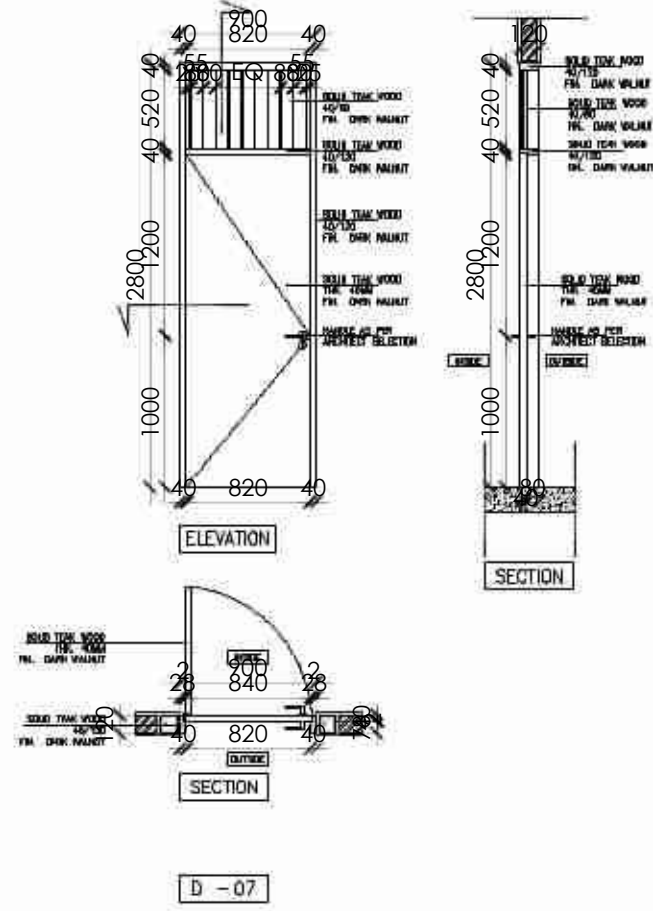
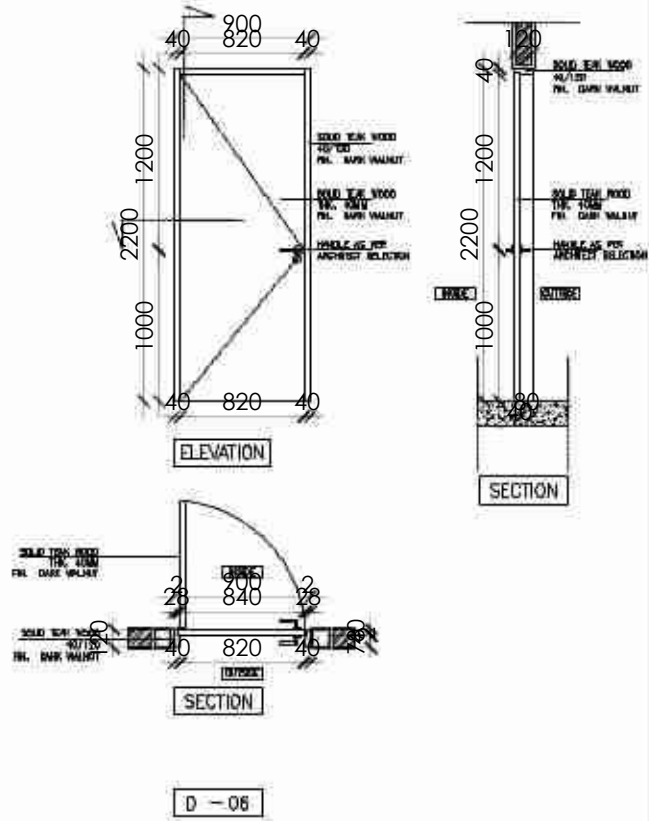

DOOR AND WINDOW DETAIL 2
Scale 1 : 50

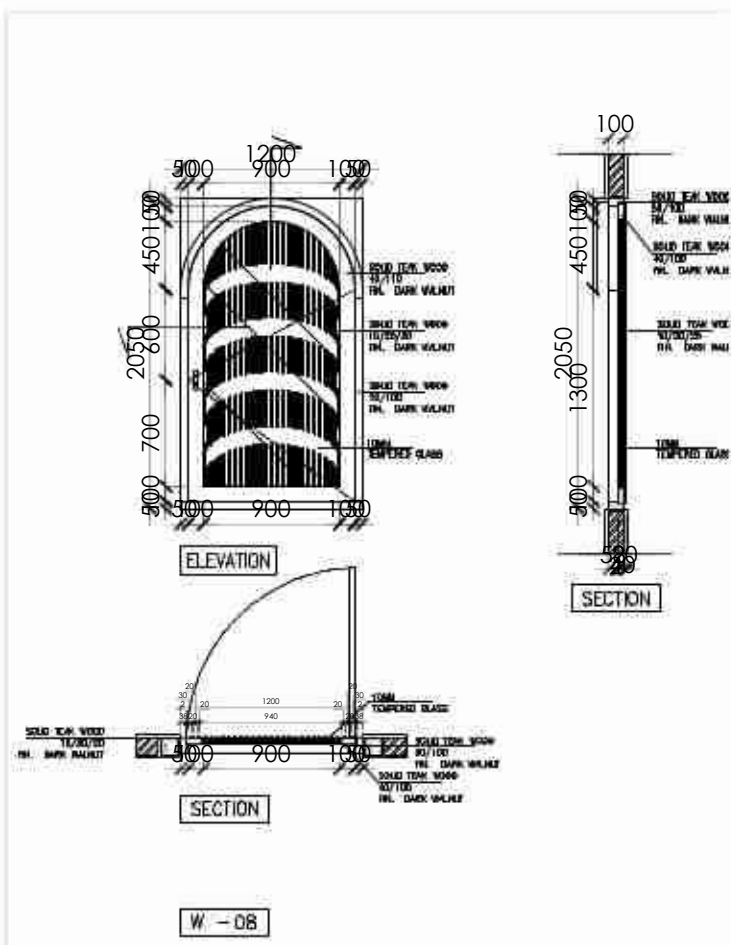
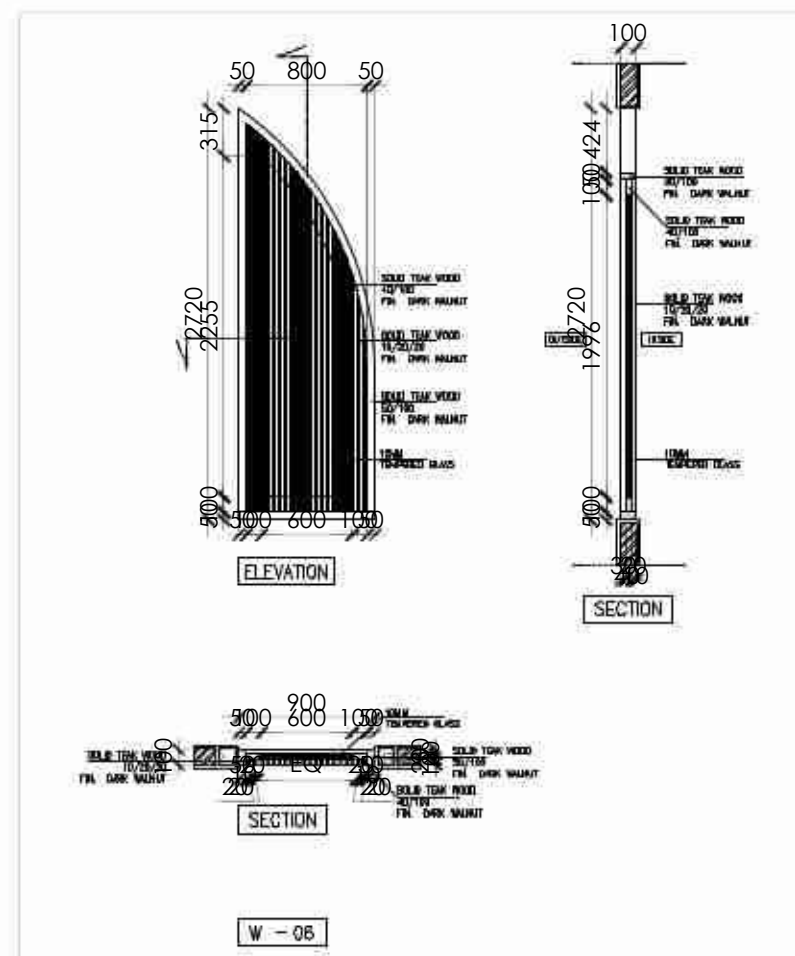
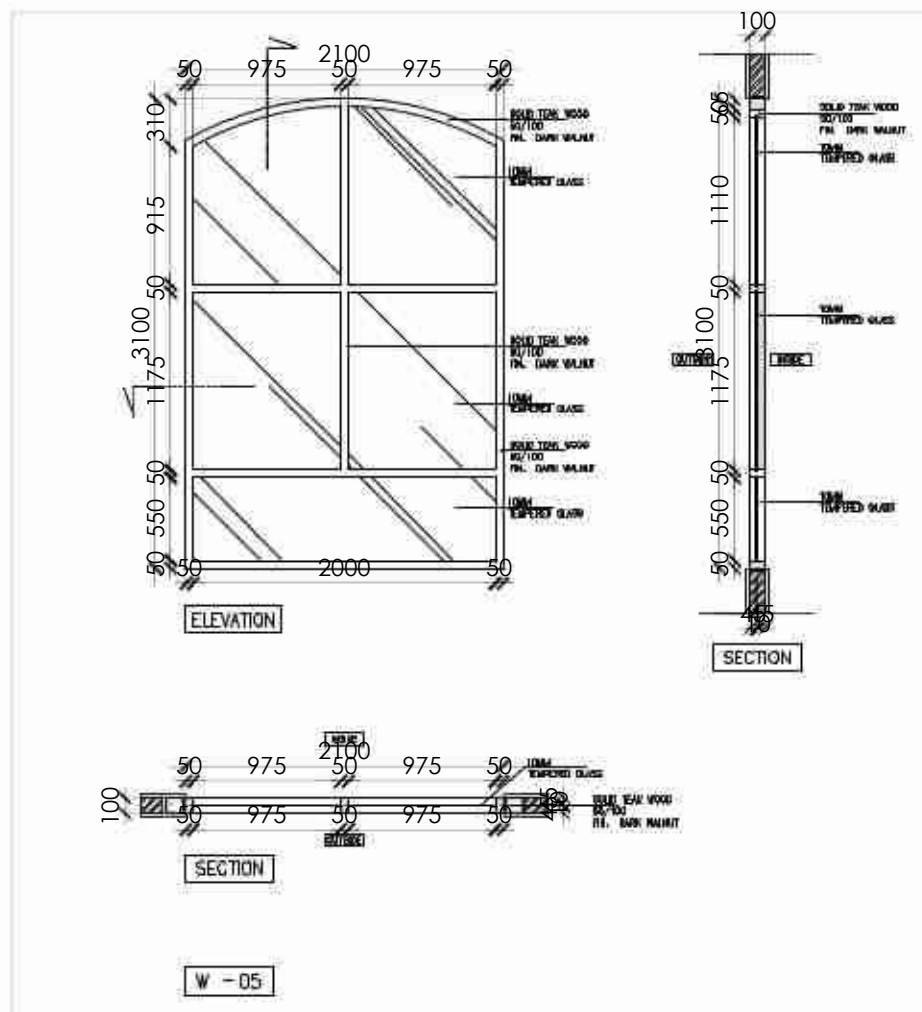
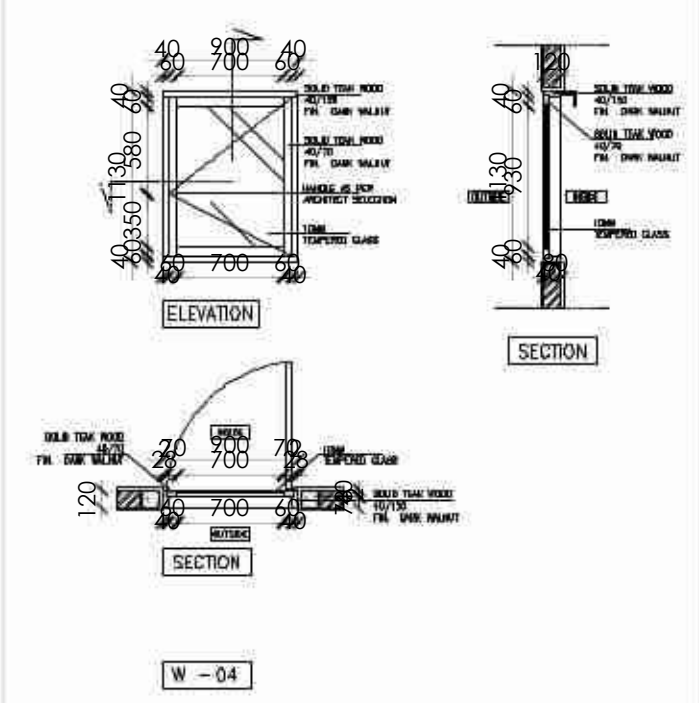
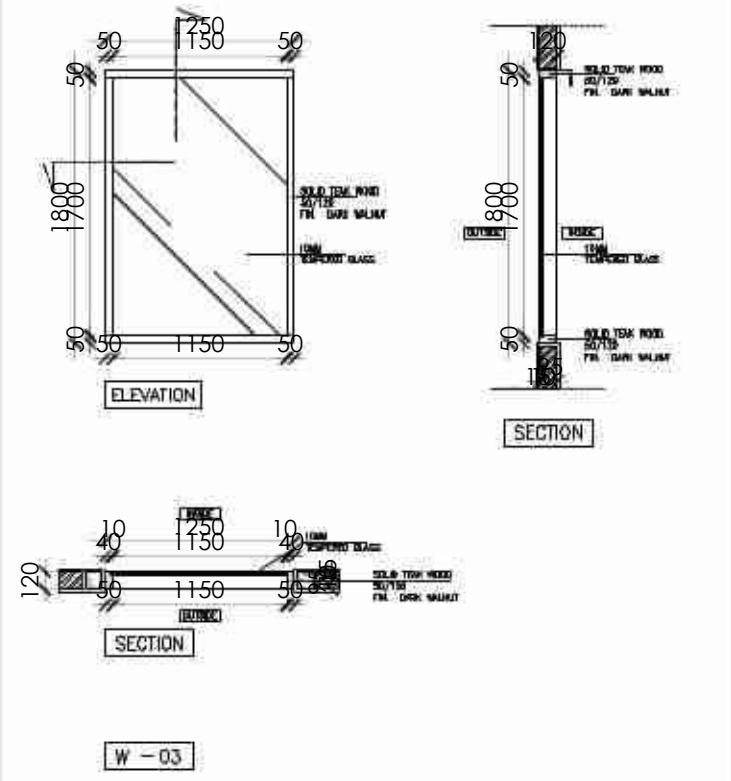
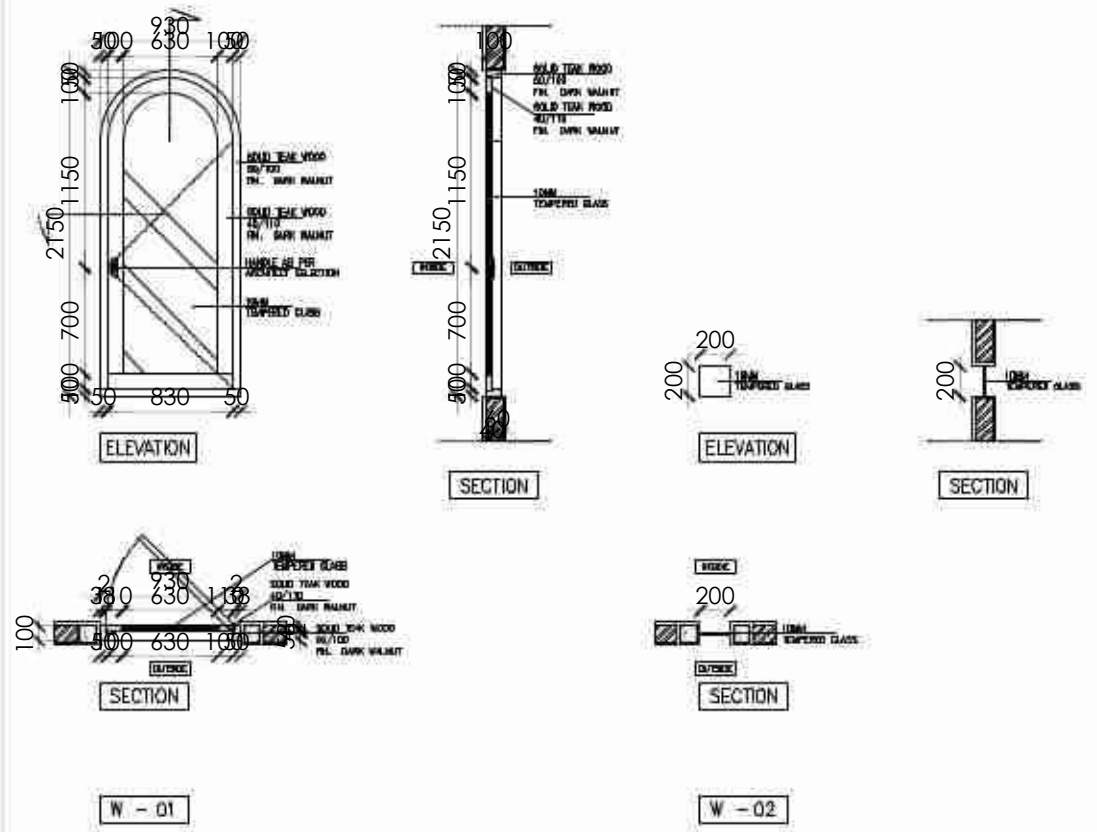

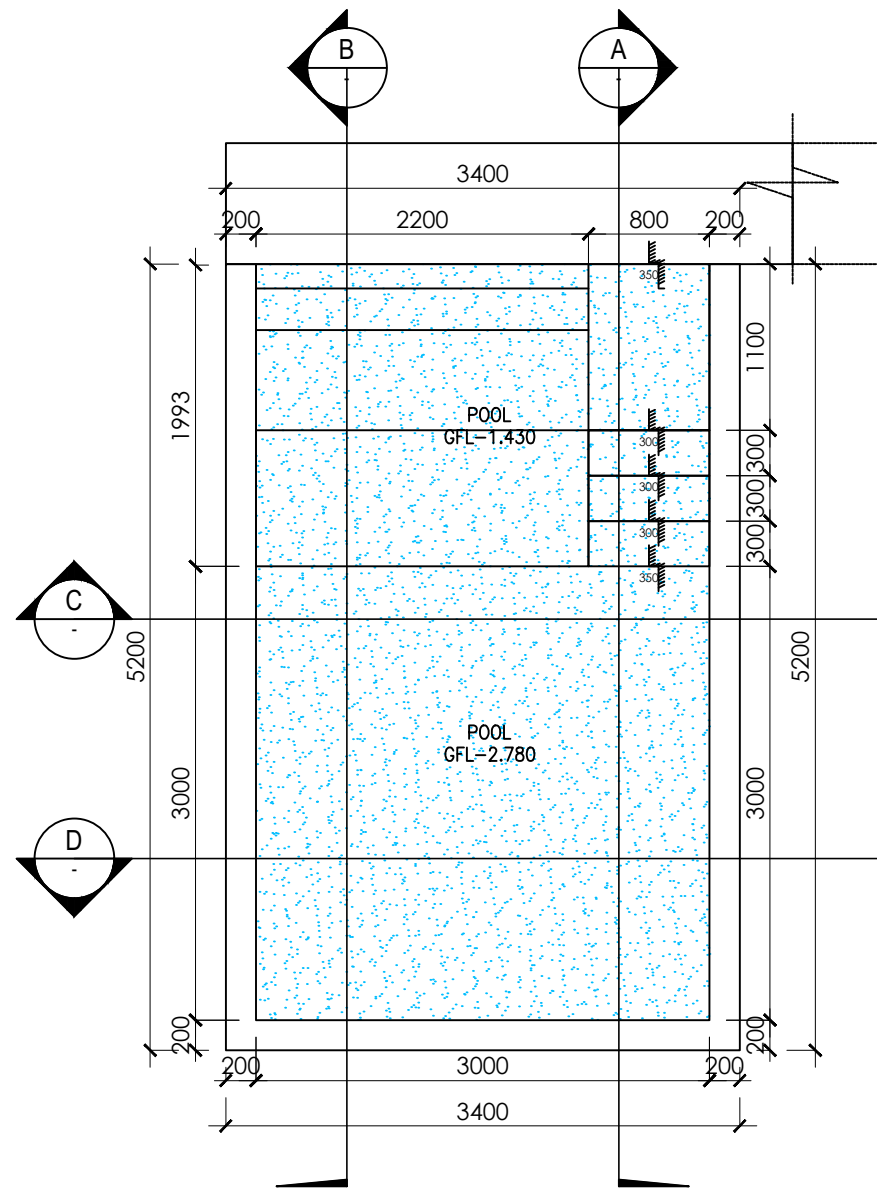

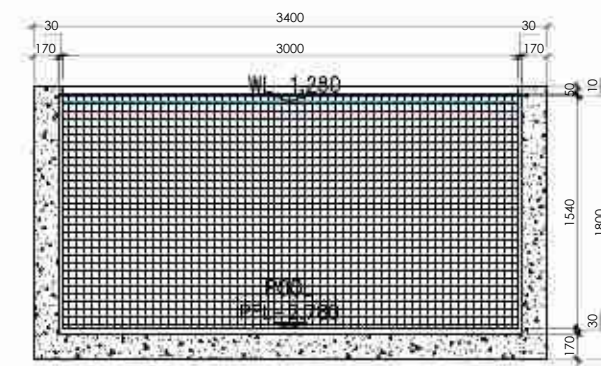
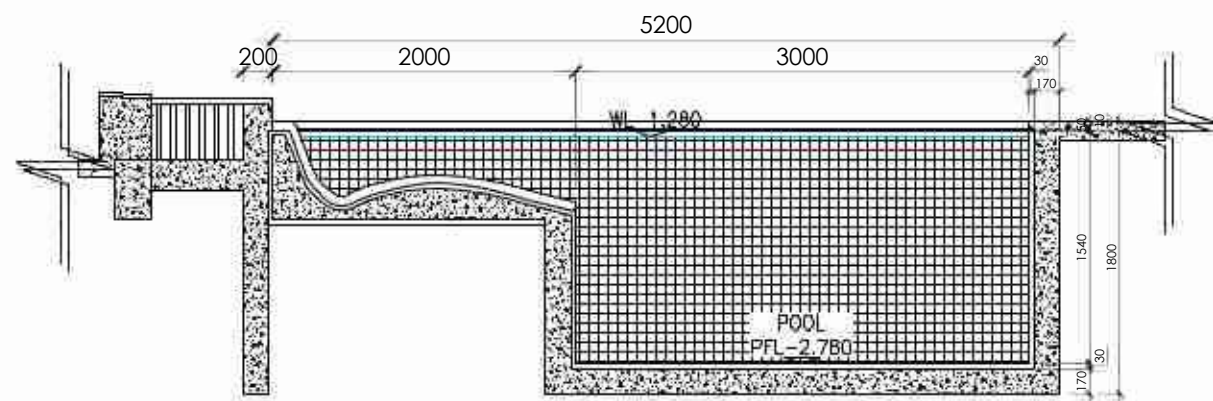
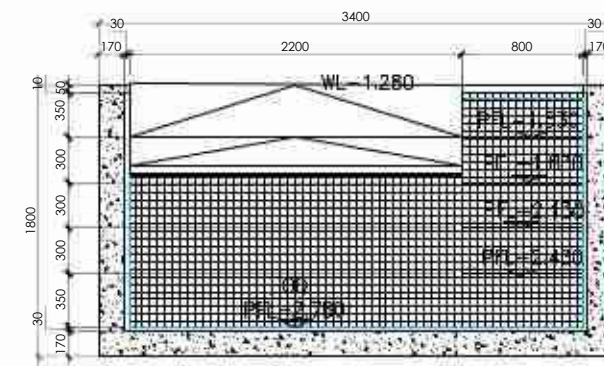
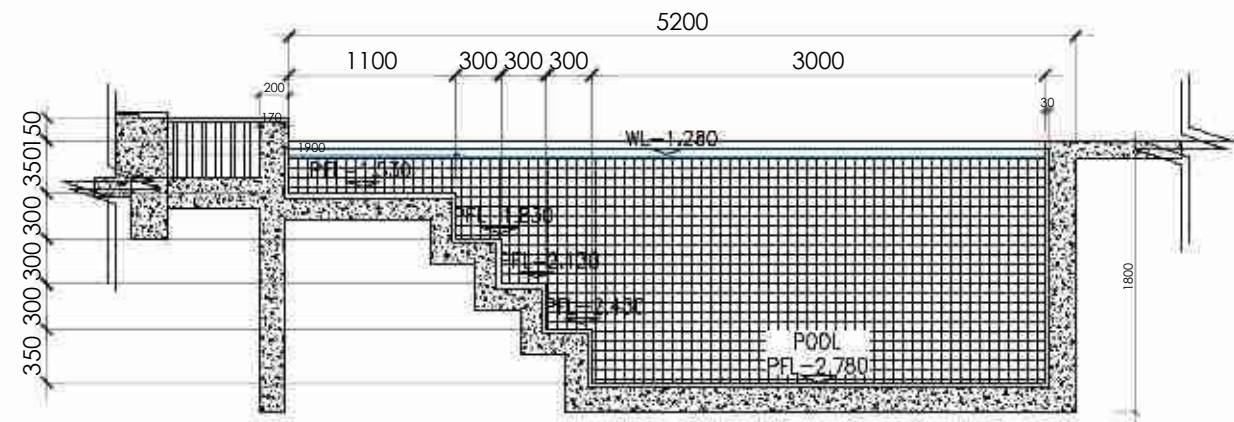

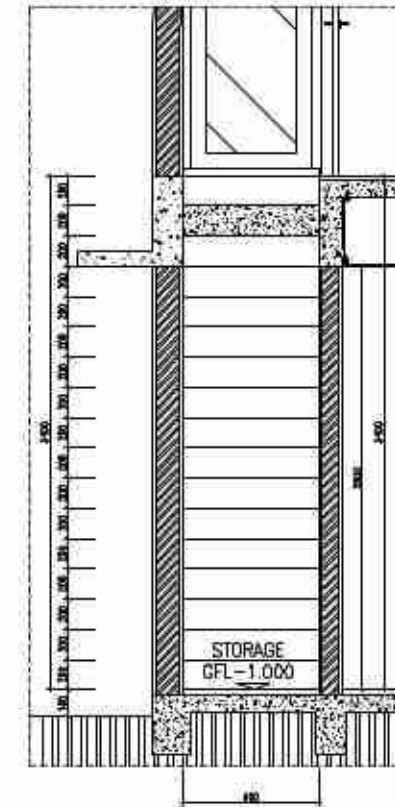
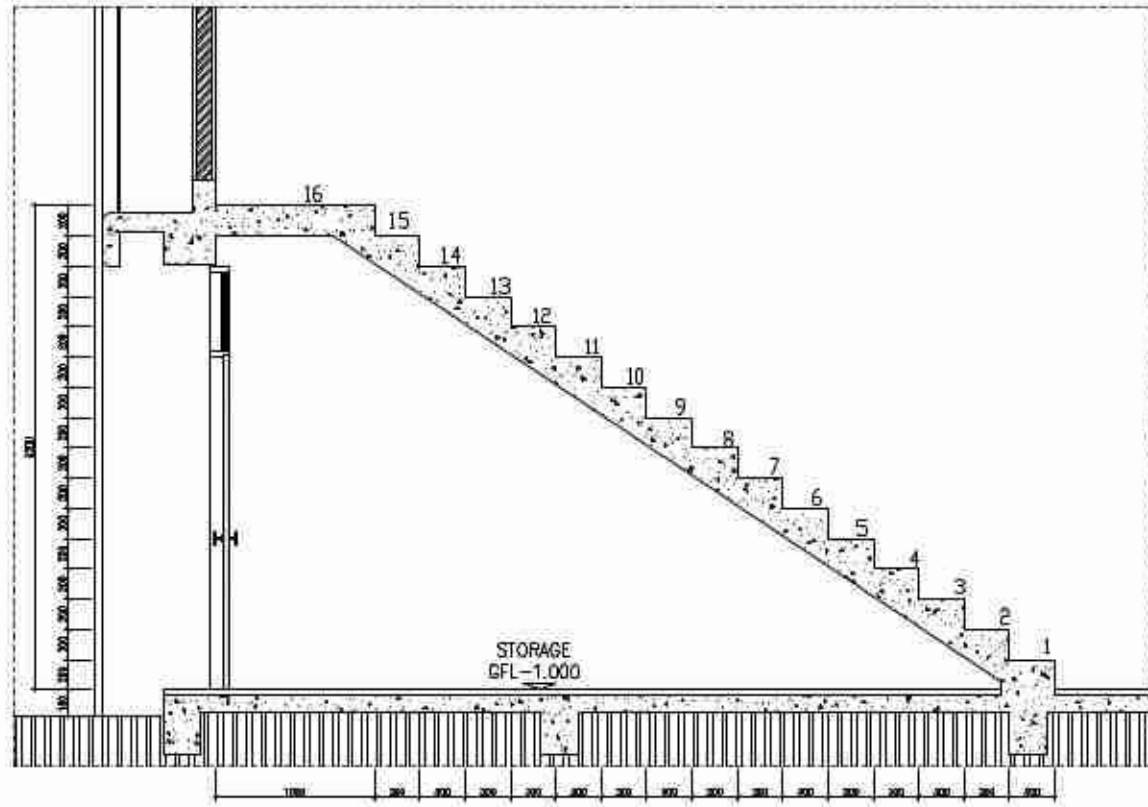
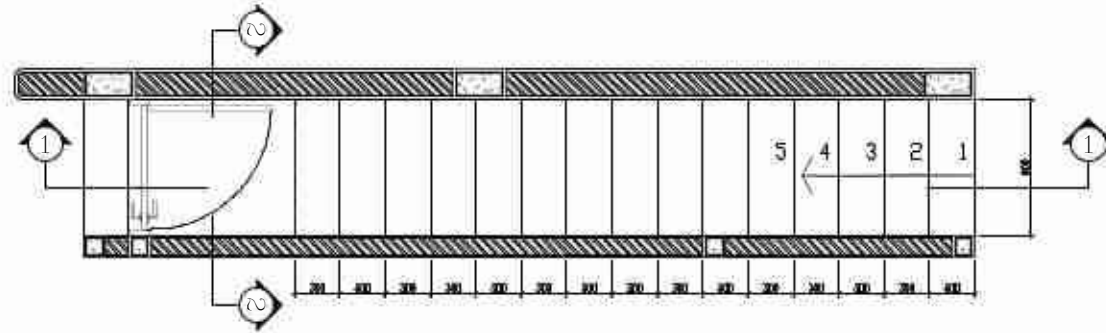
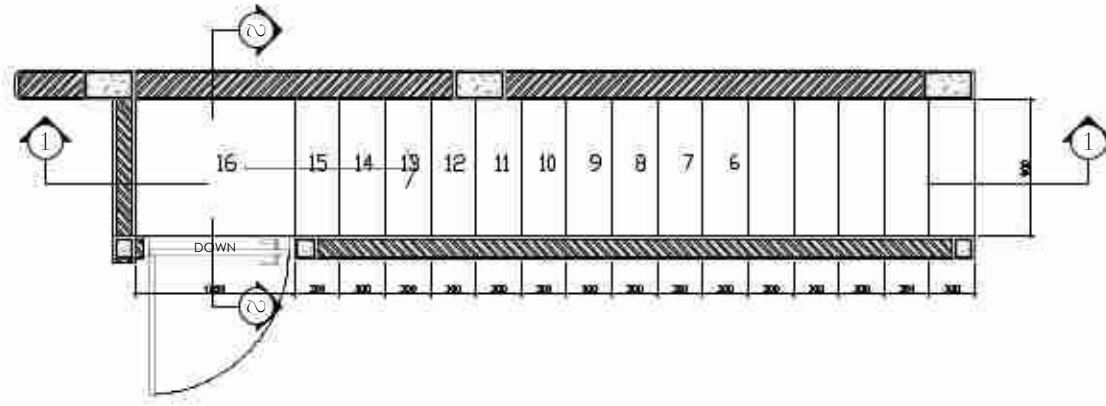

STAIR PLAN, SECTION AND DETAIL VILLA B
Scale 1 : 50

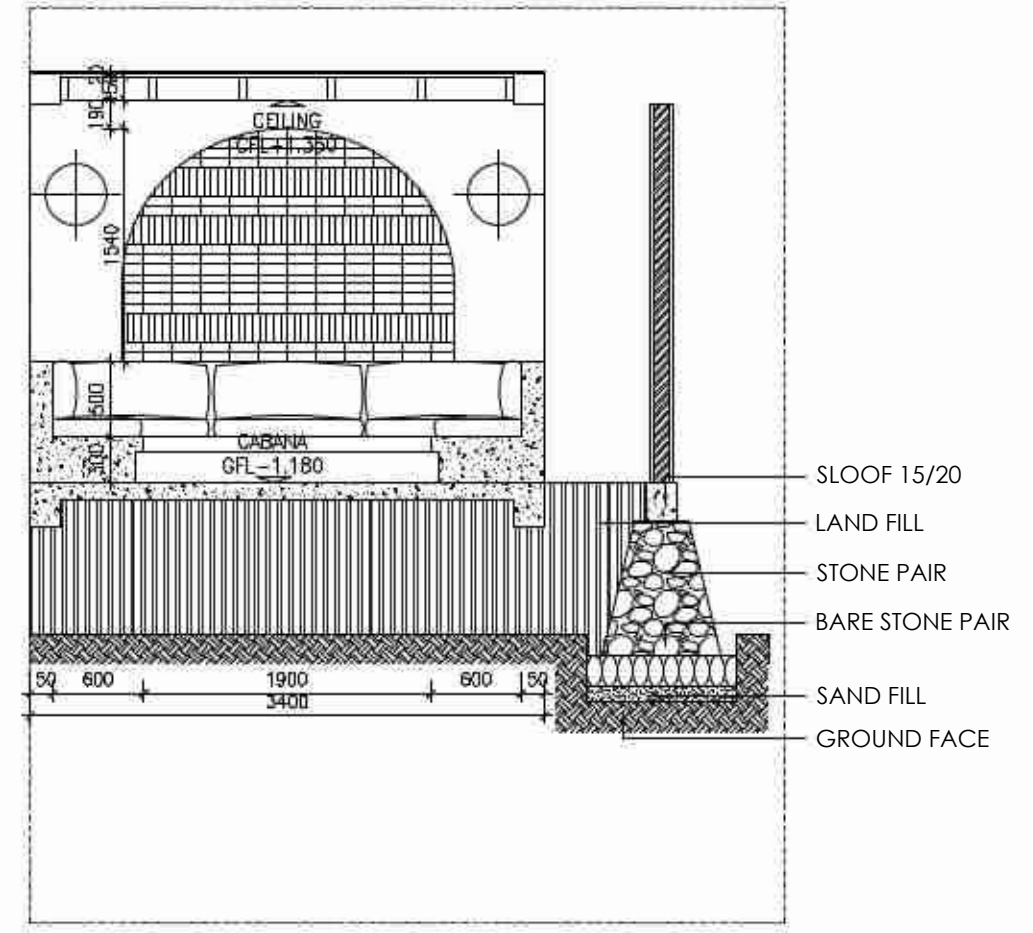
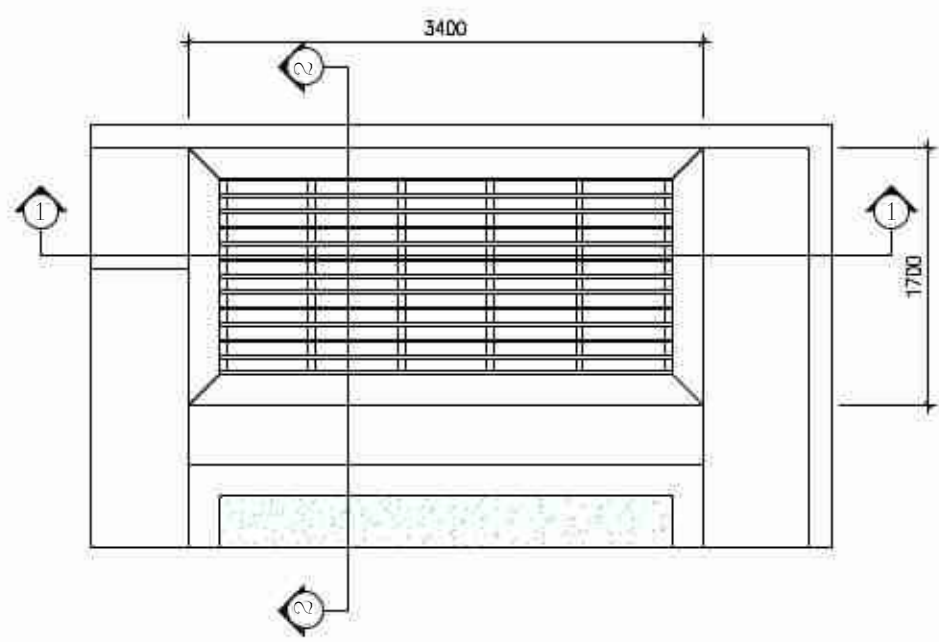
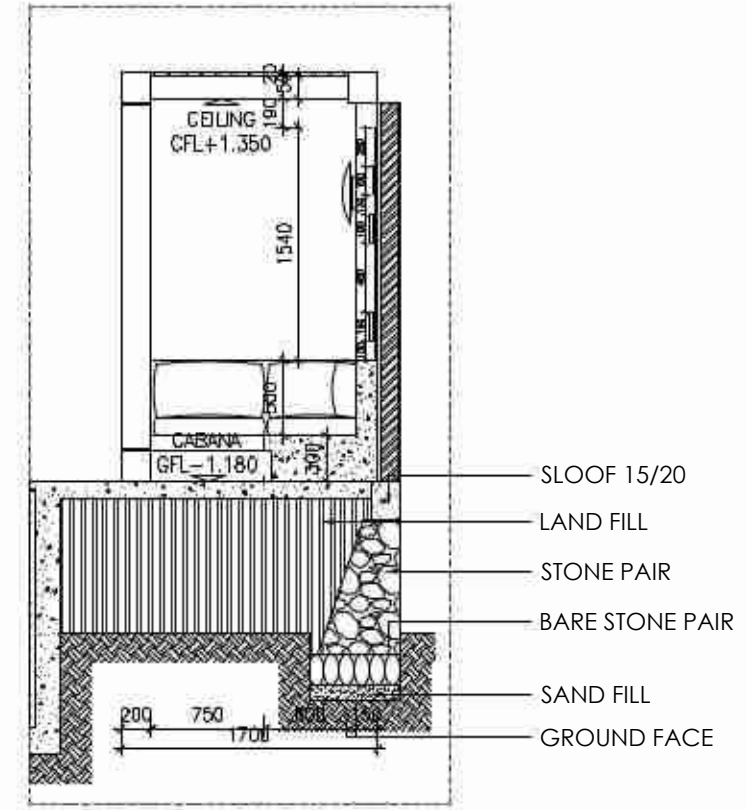
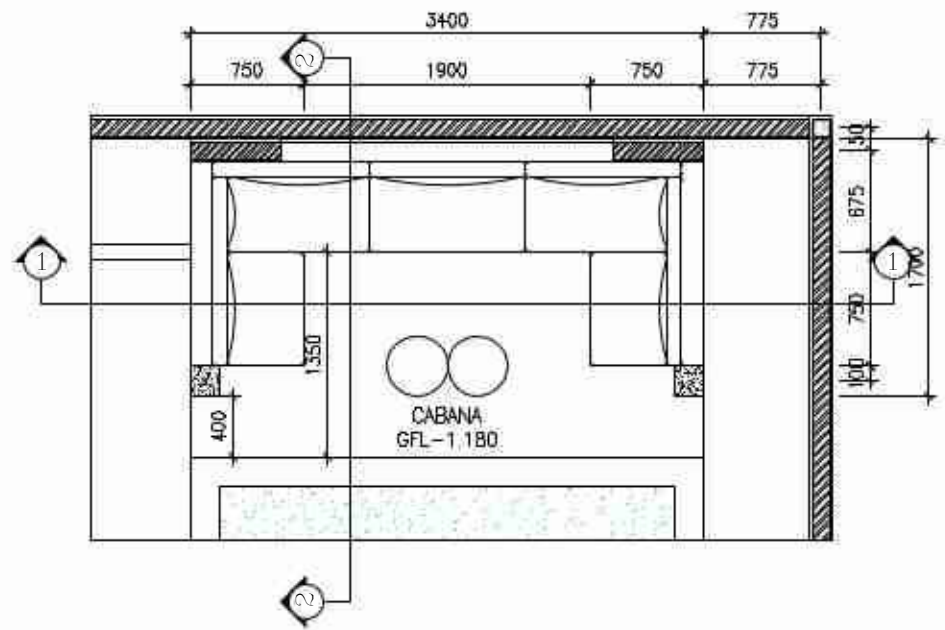

CABANA PLAN, SECTION AND DETAIL VILLA B
Scale 1 : 50

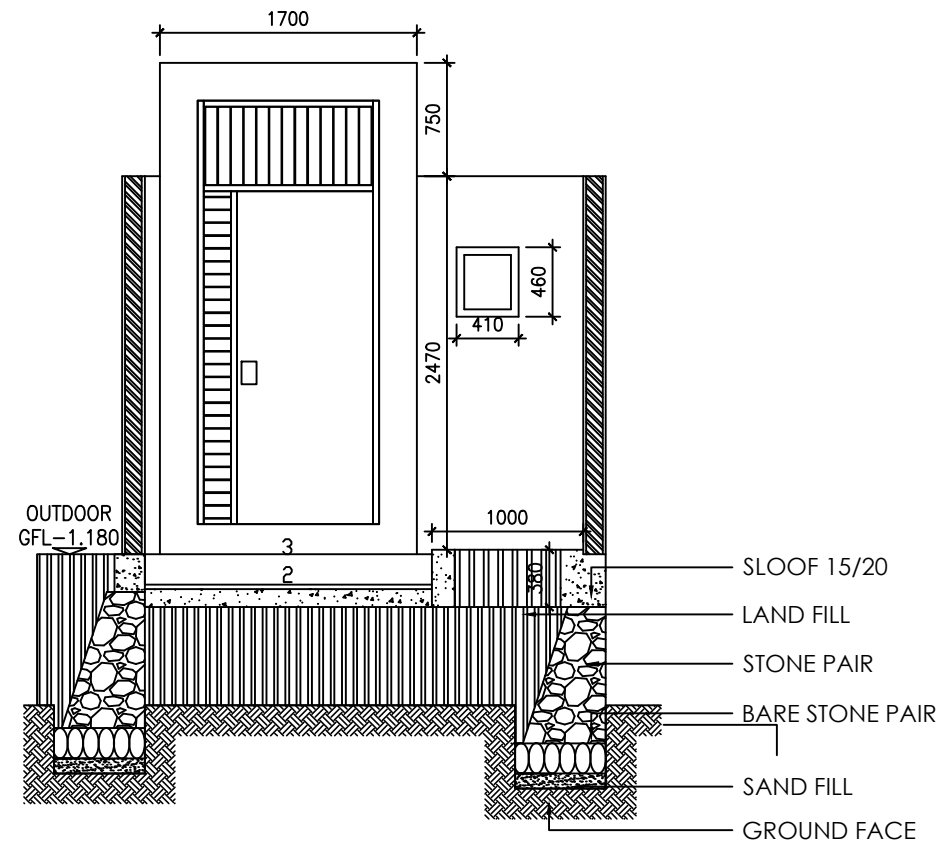
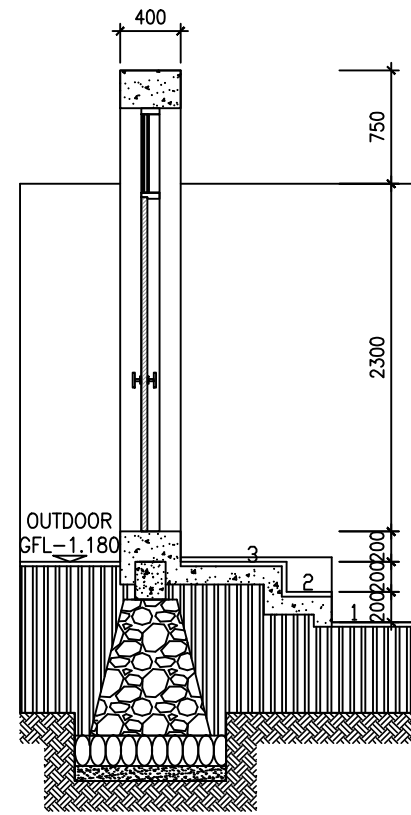
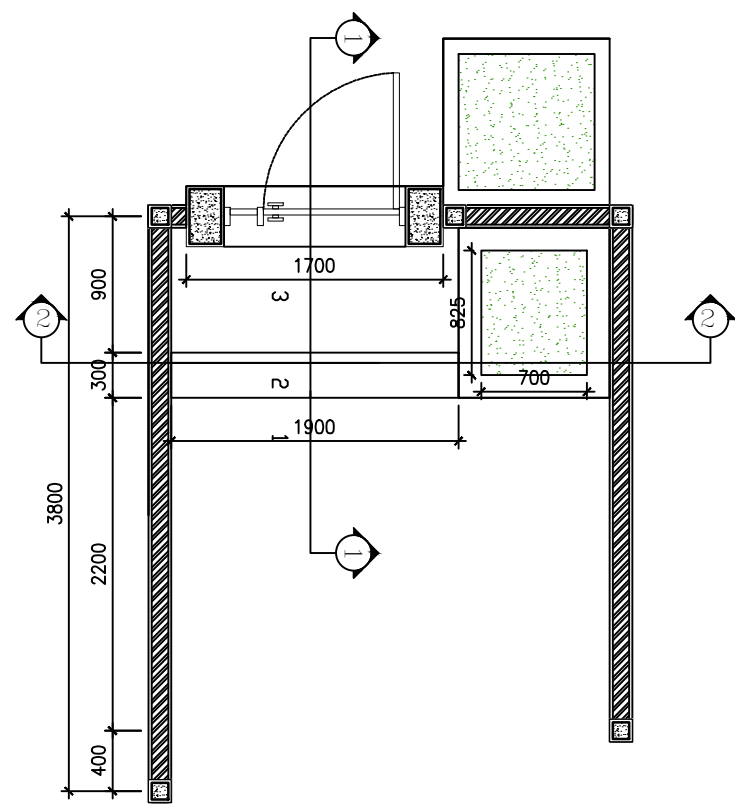

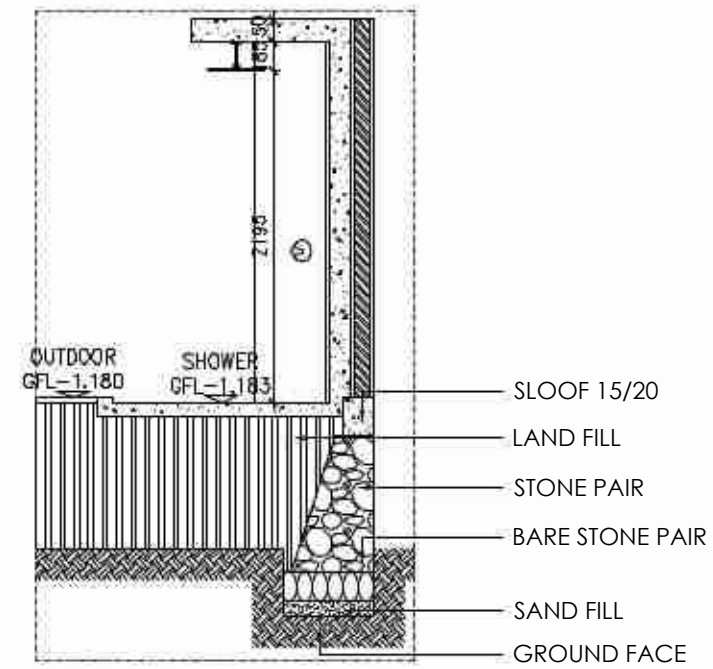
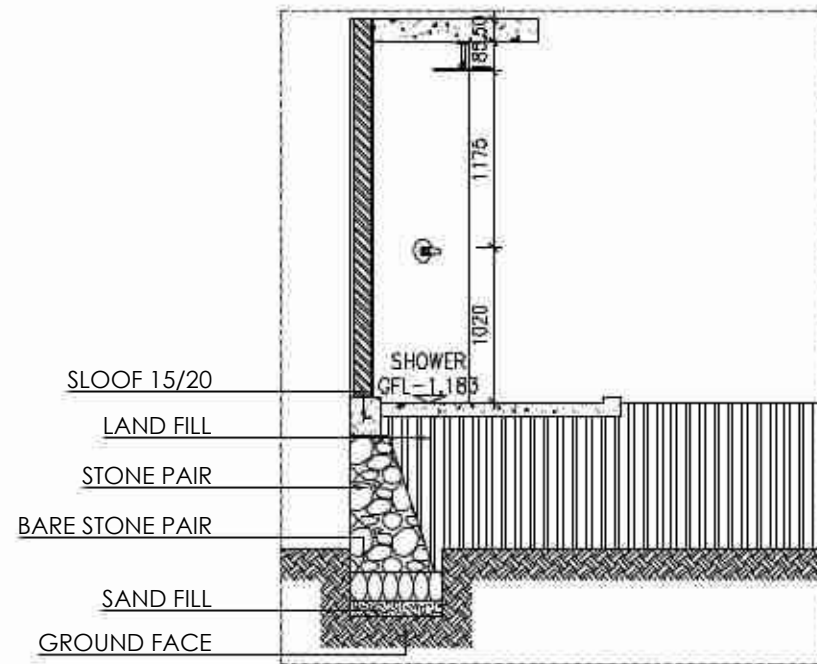
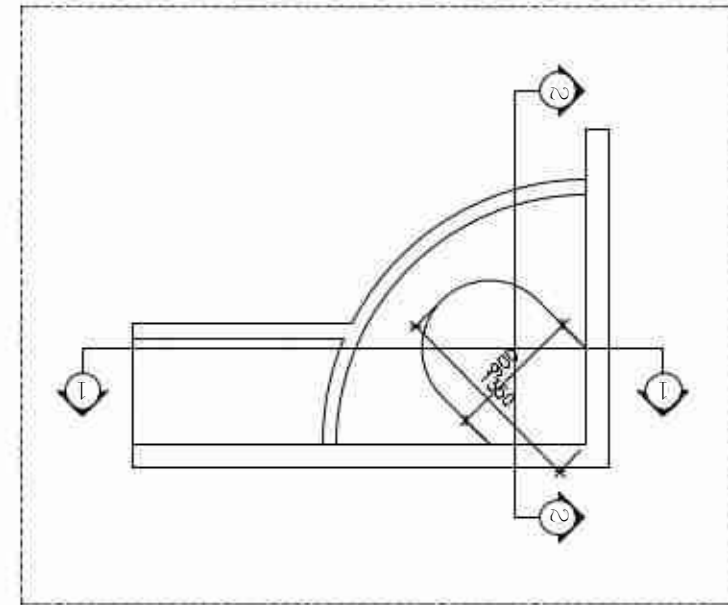
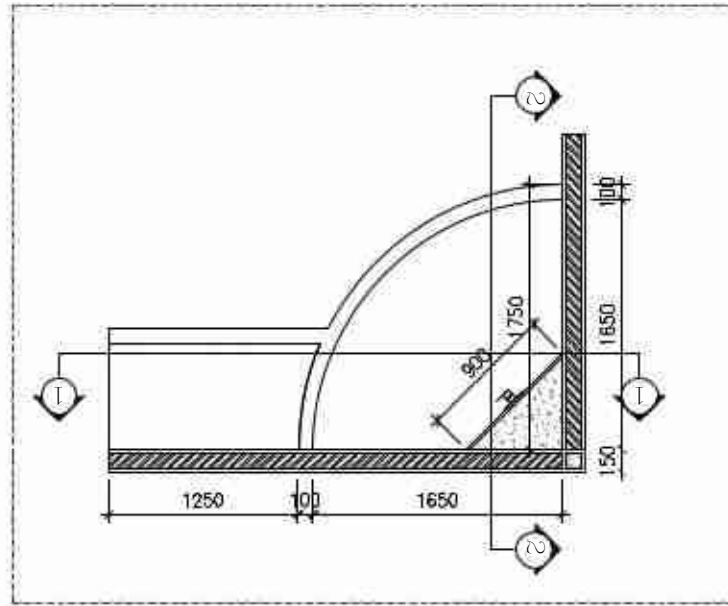

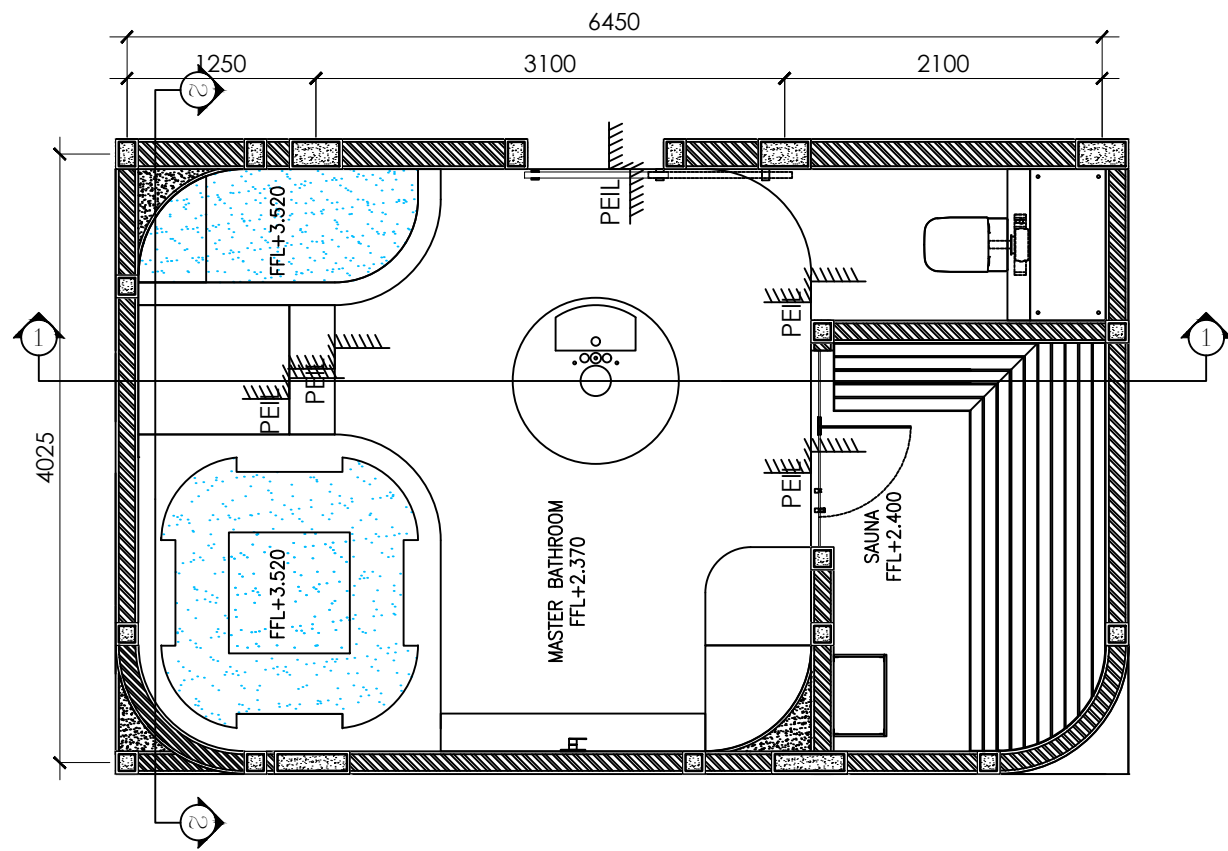
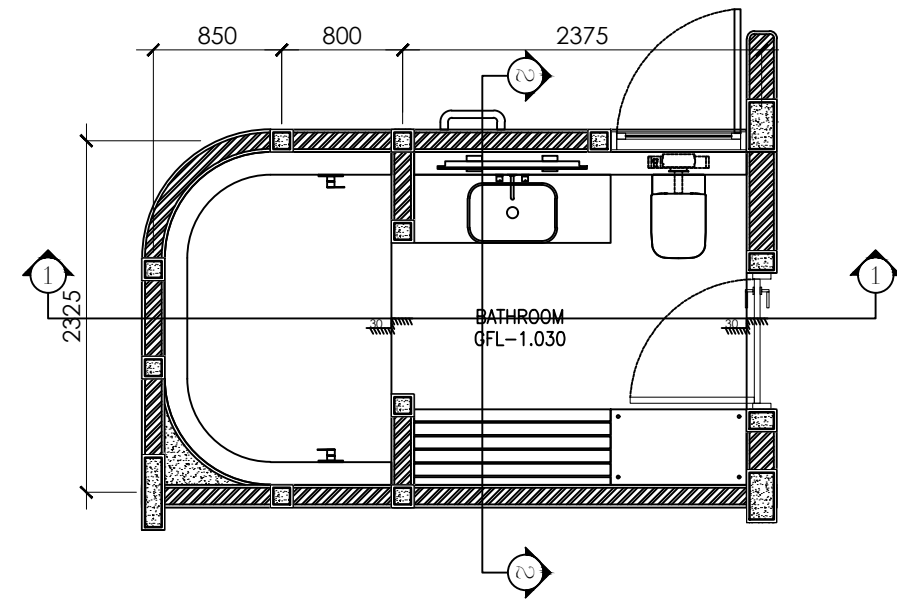

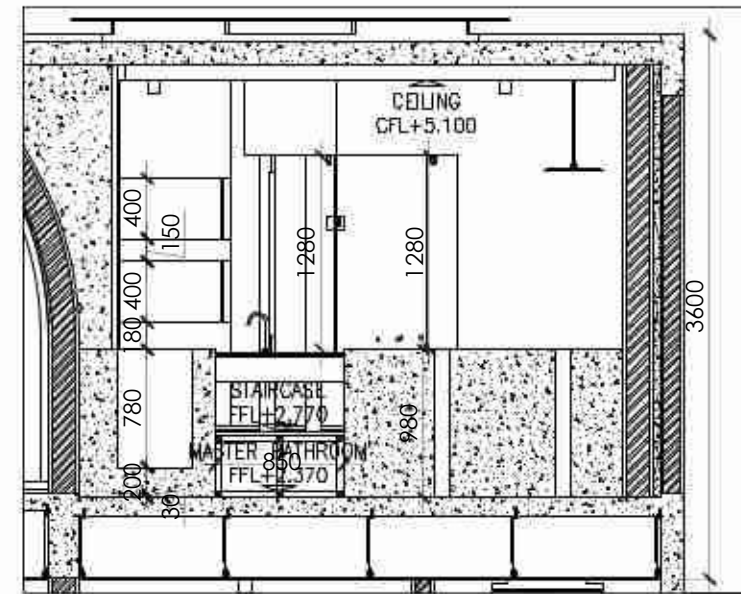
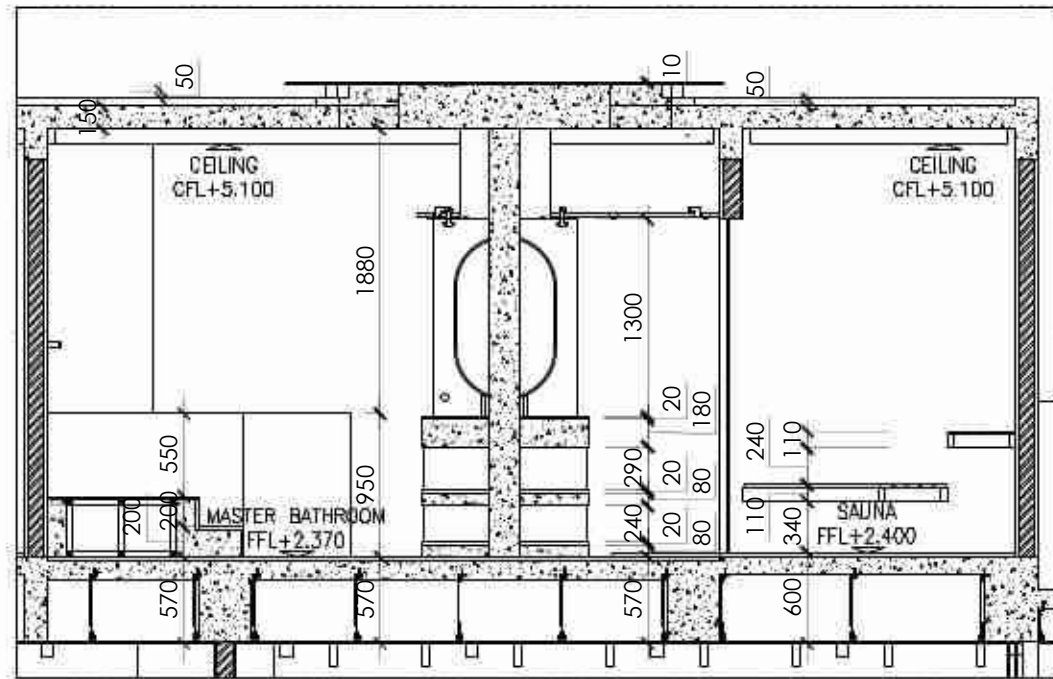
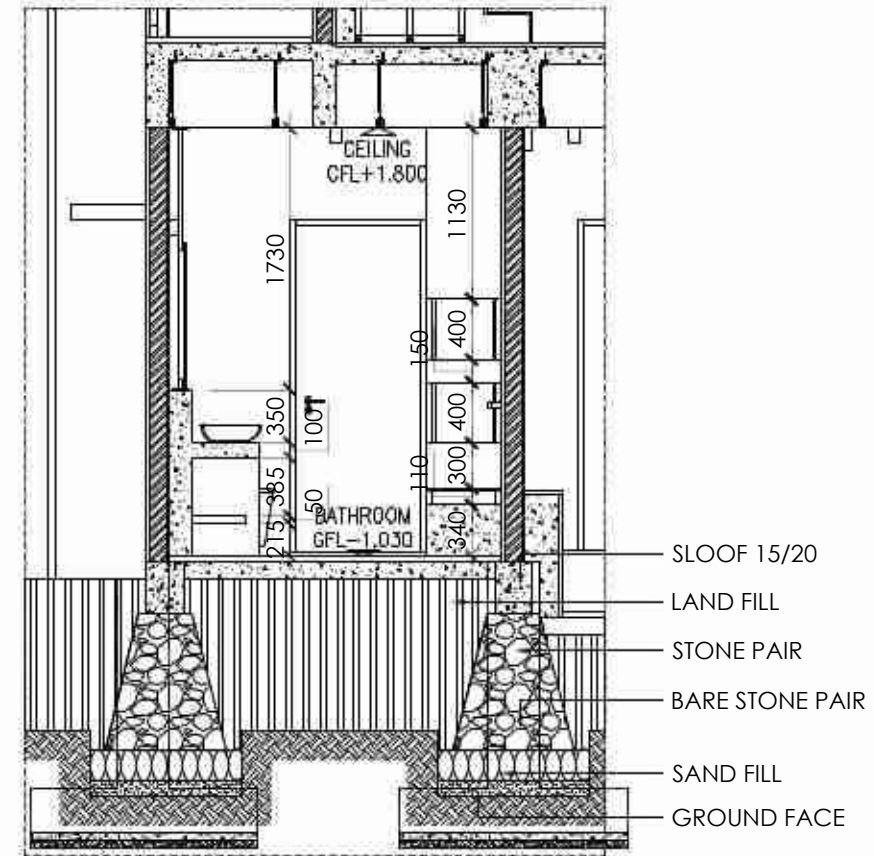
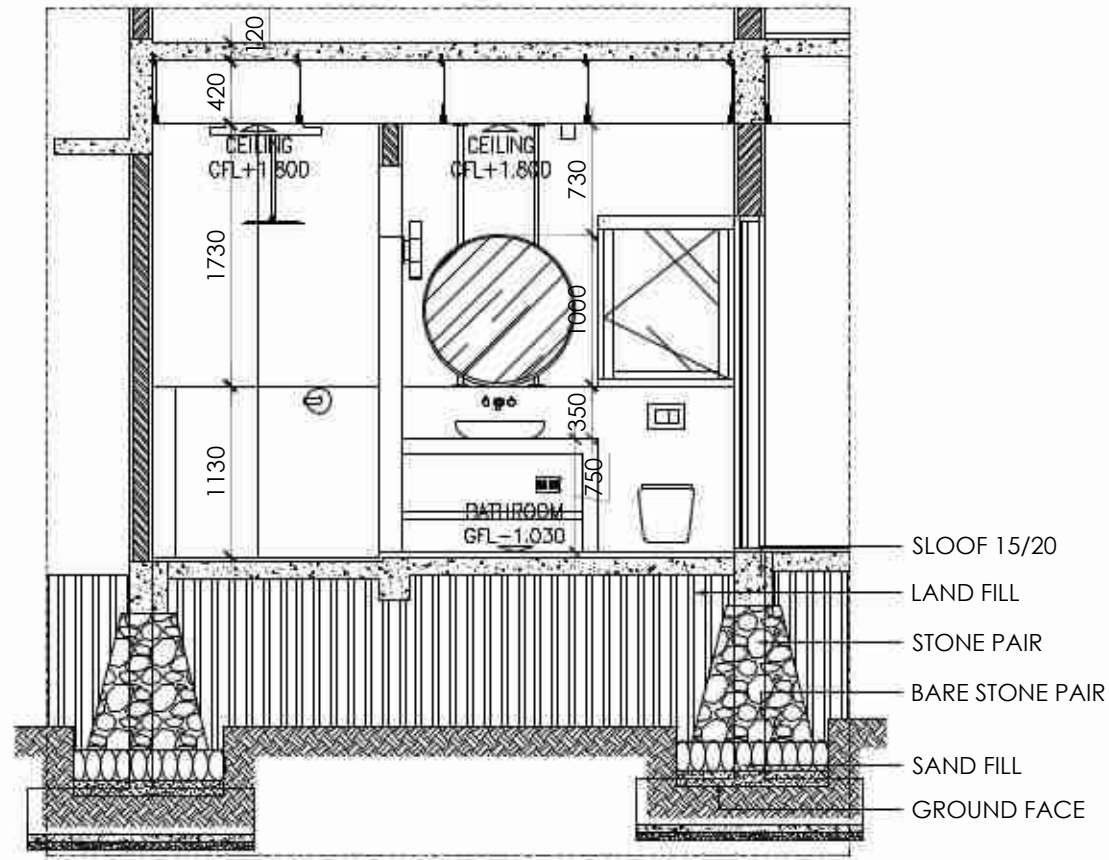

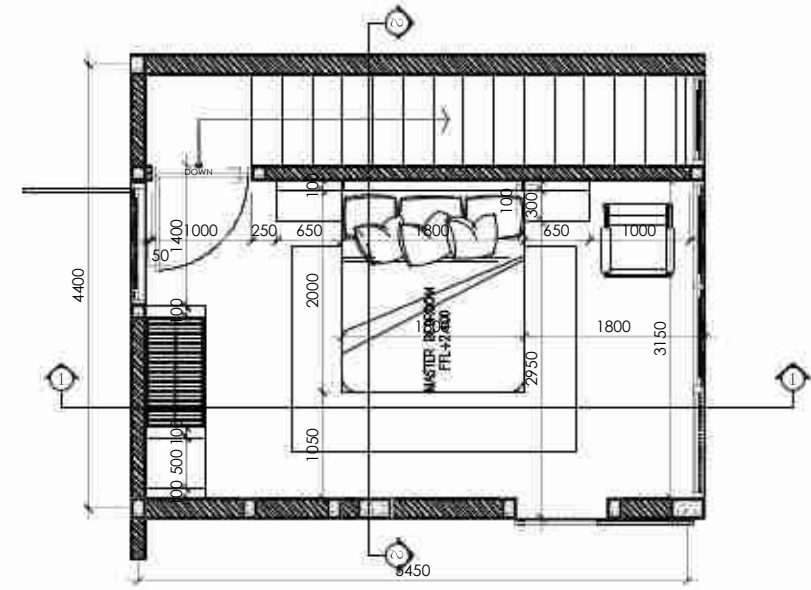
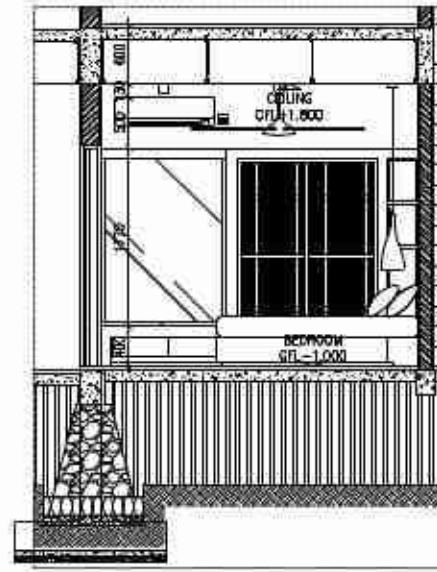
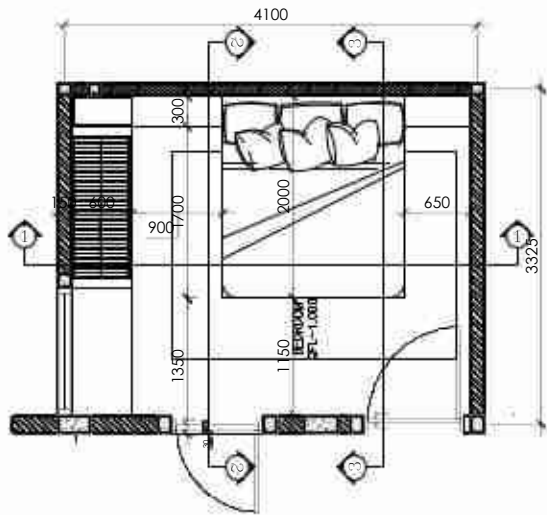
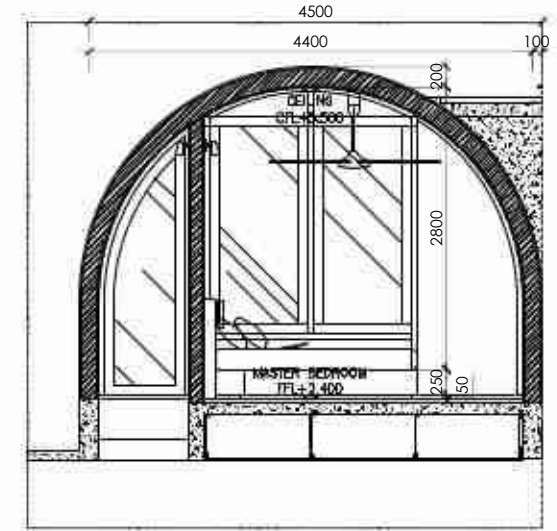
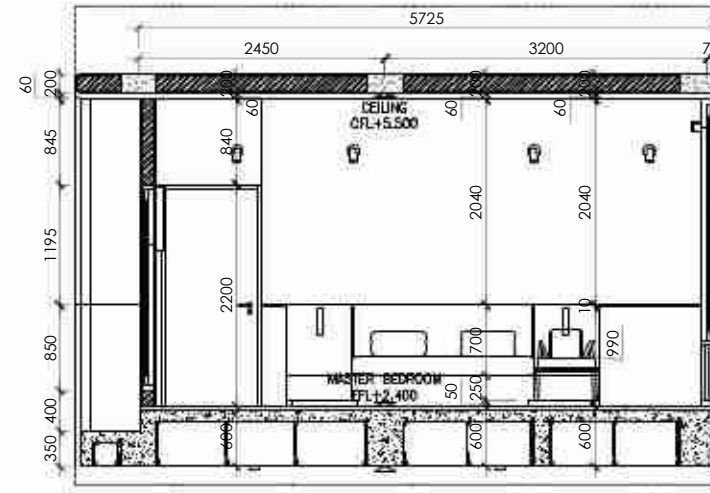
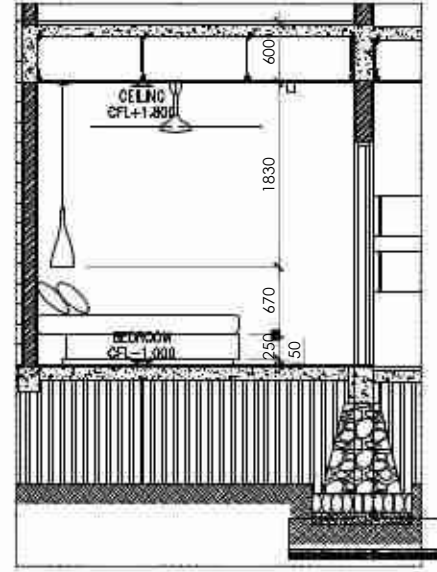
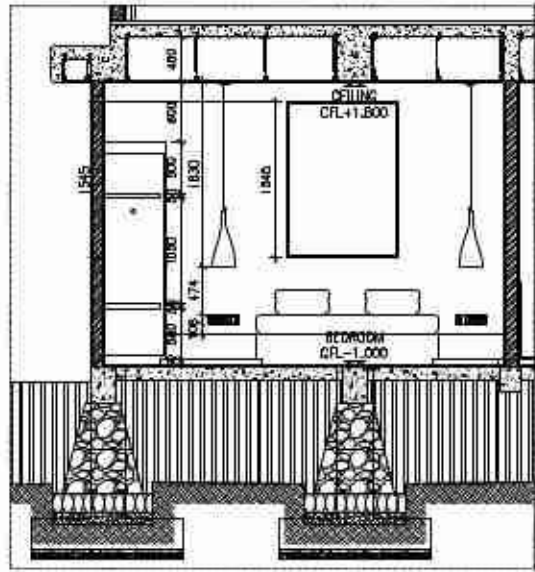

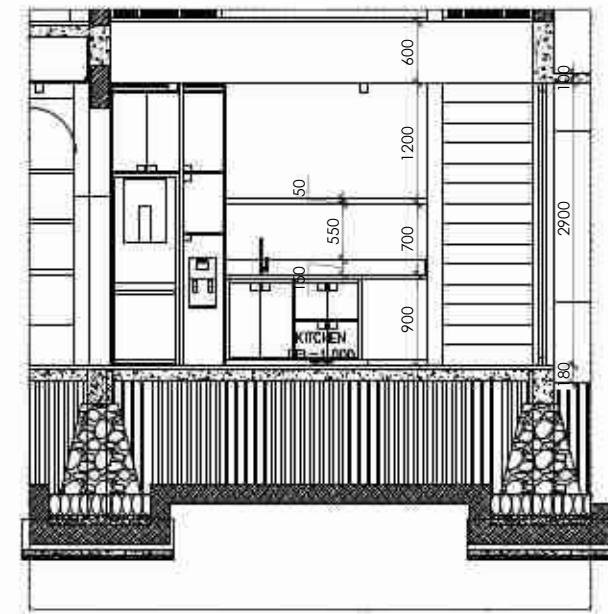
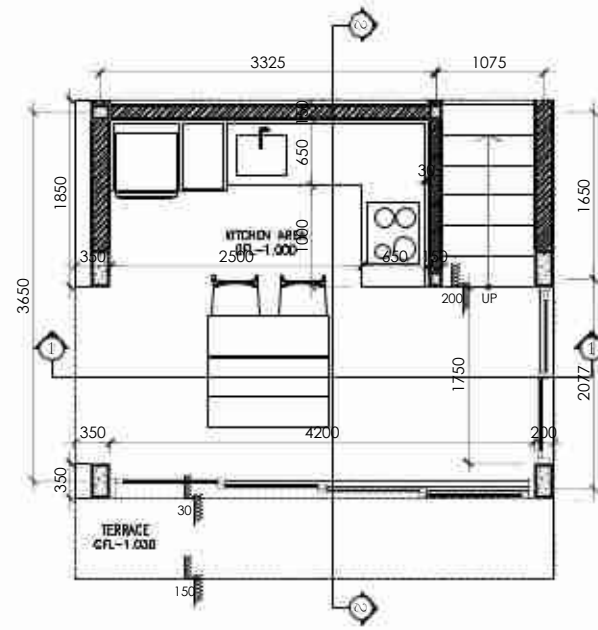
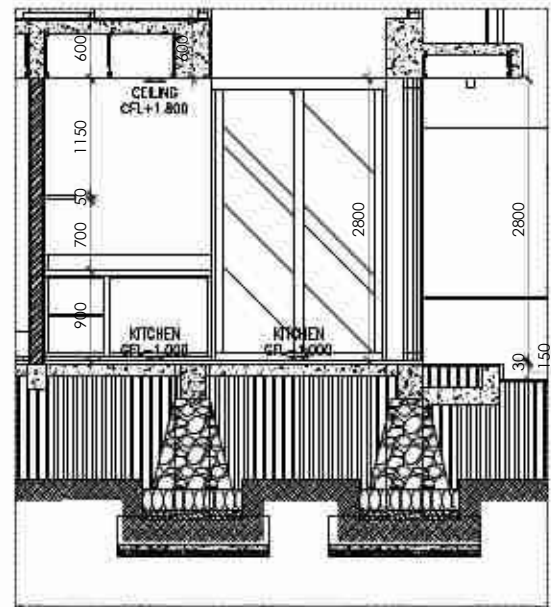

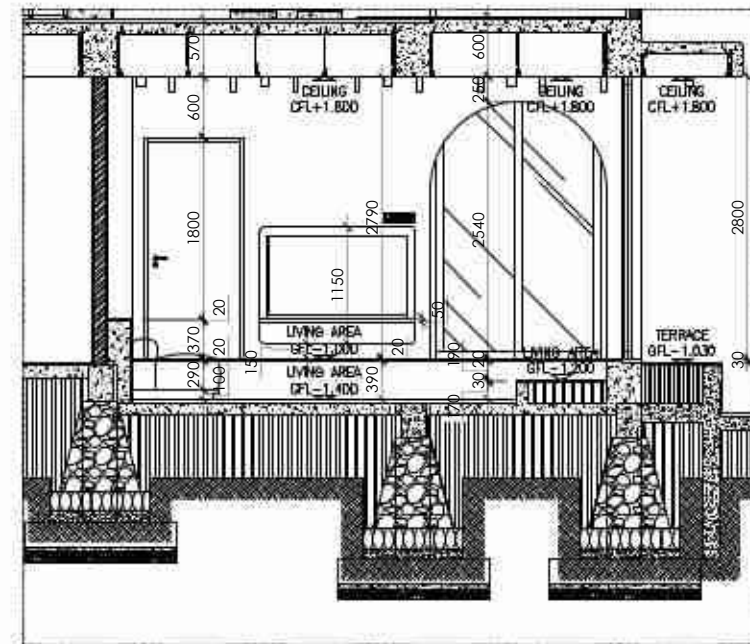
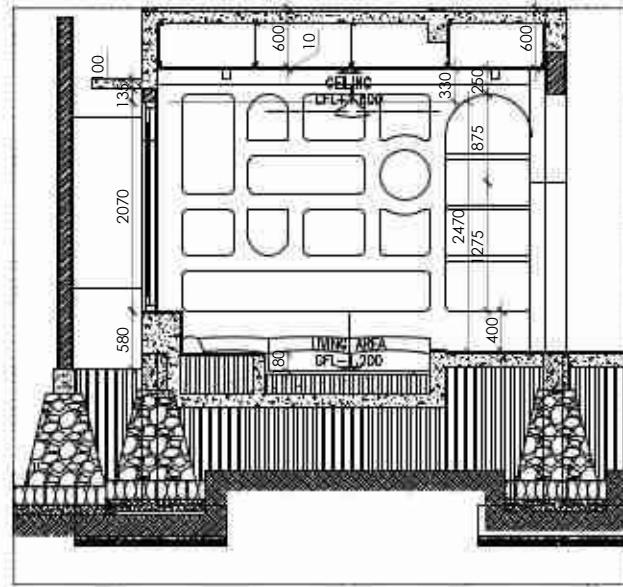
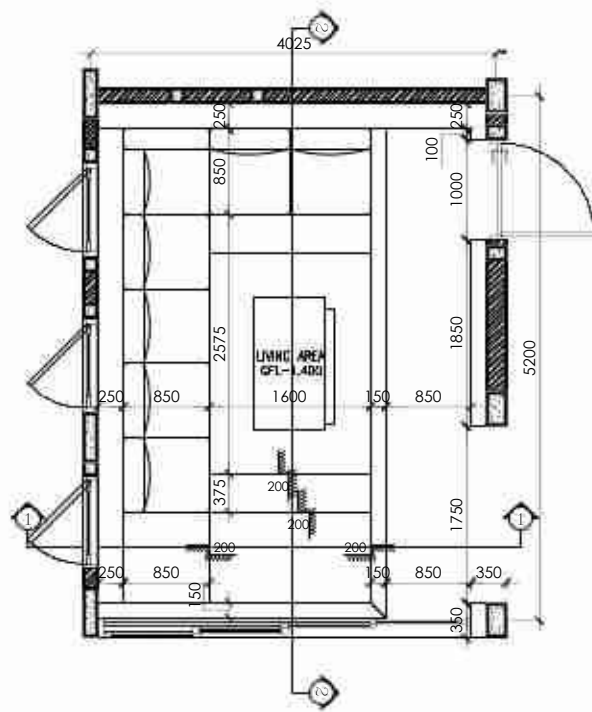

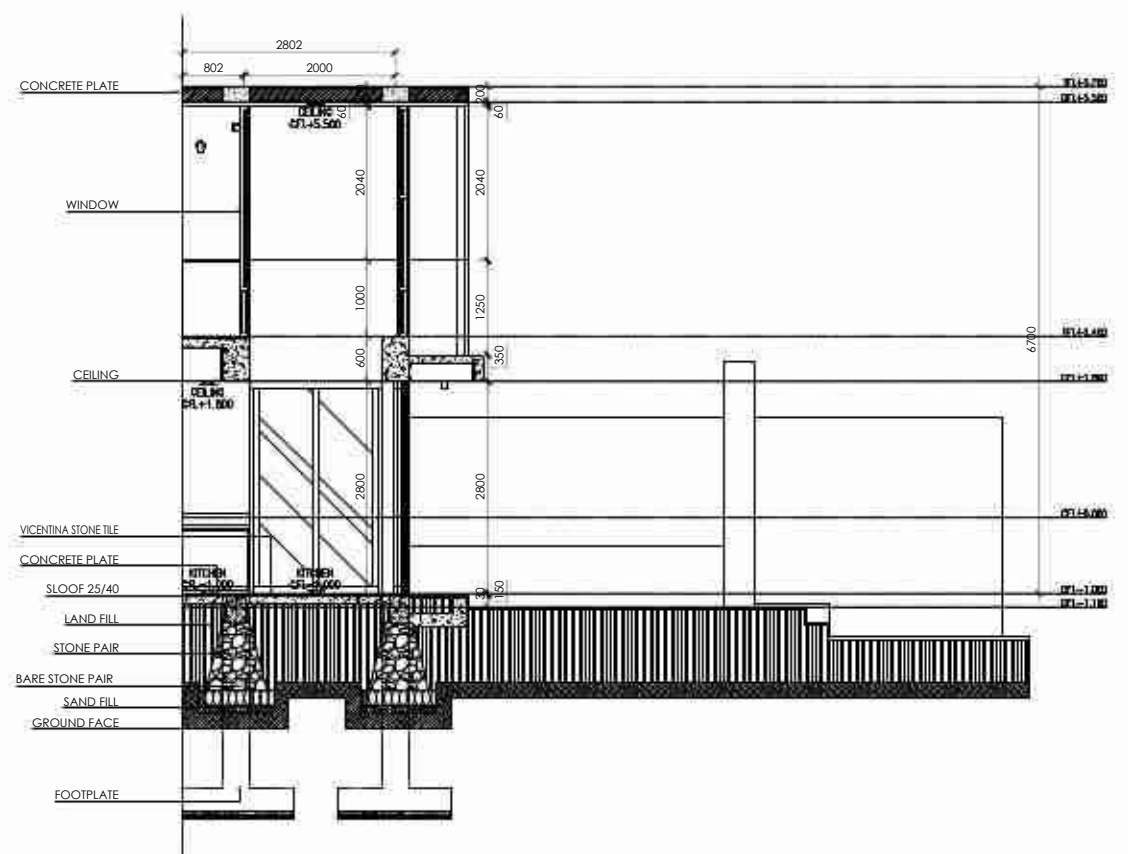
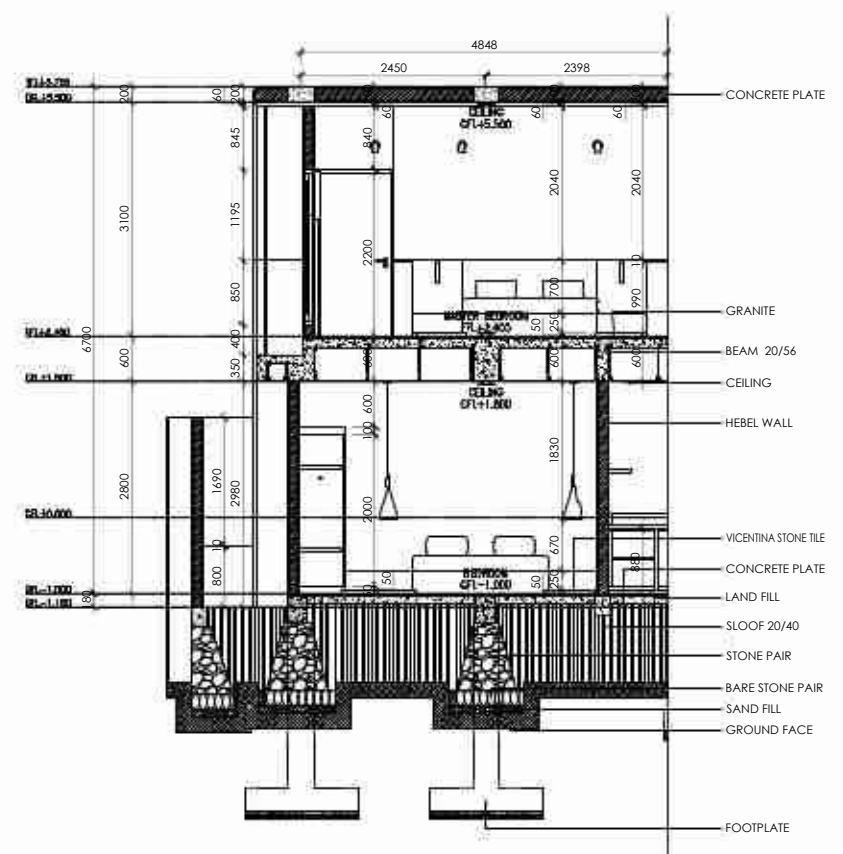
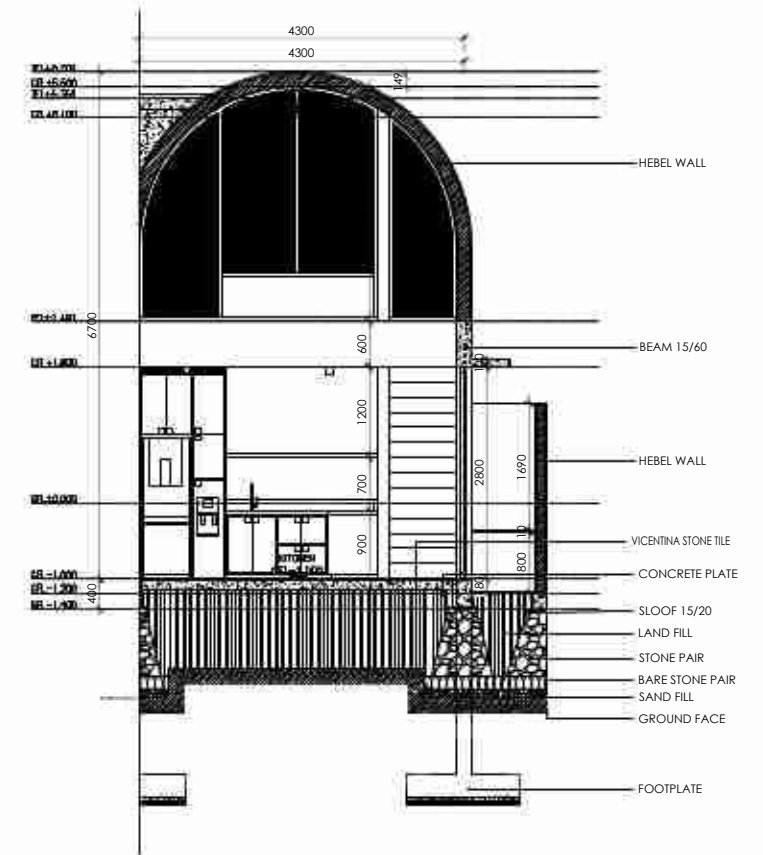
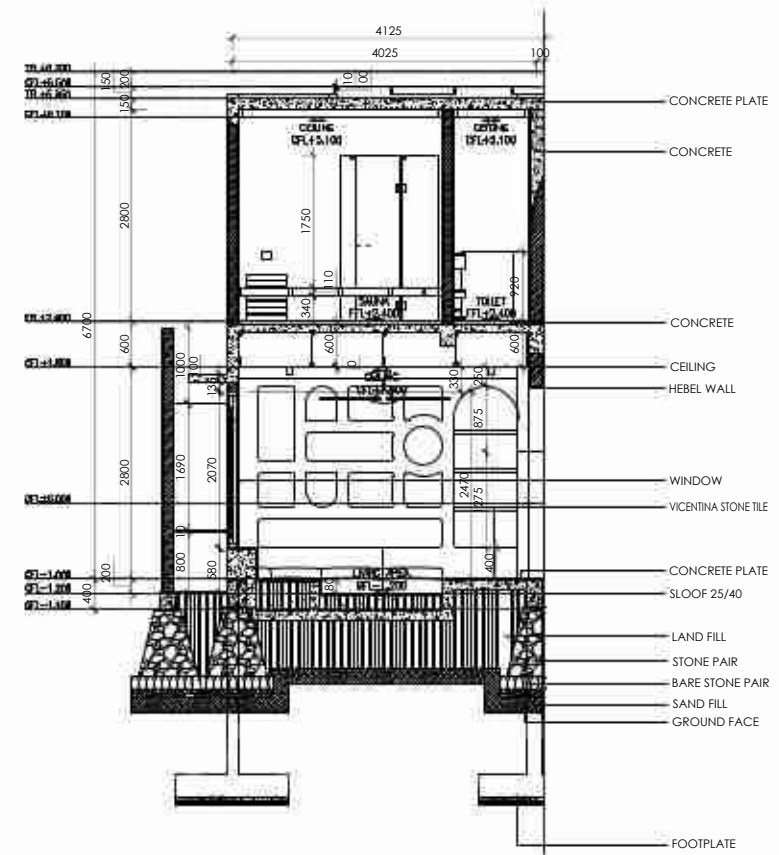

BLOW UP SECTION 1 VILLA B
Scale 1 : 100

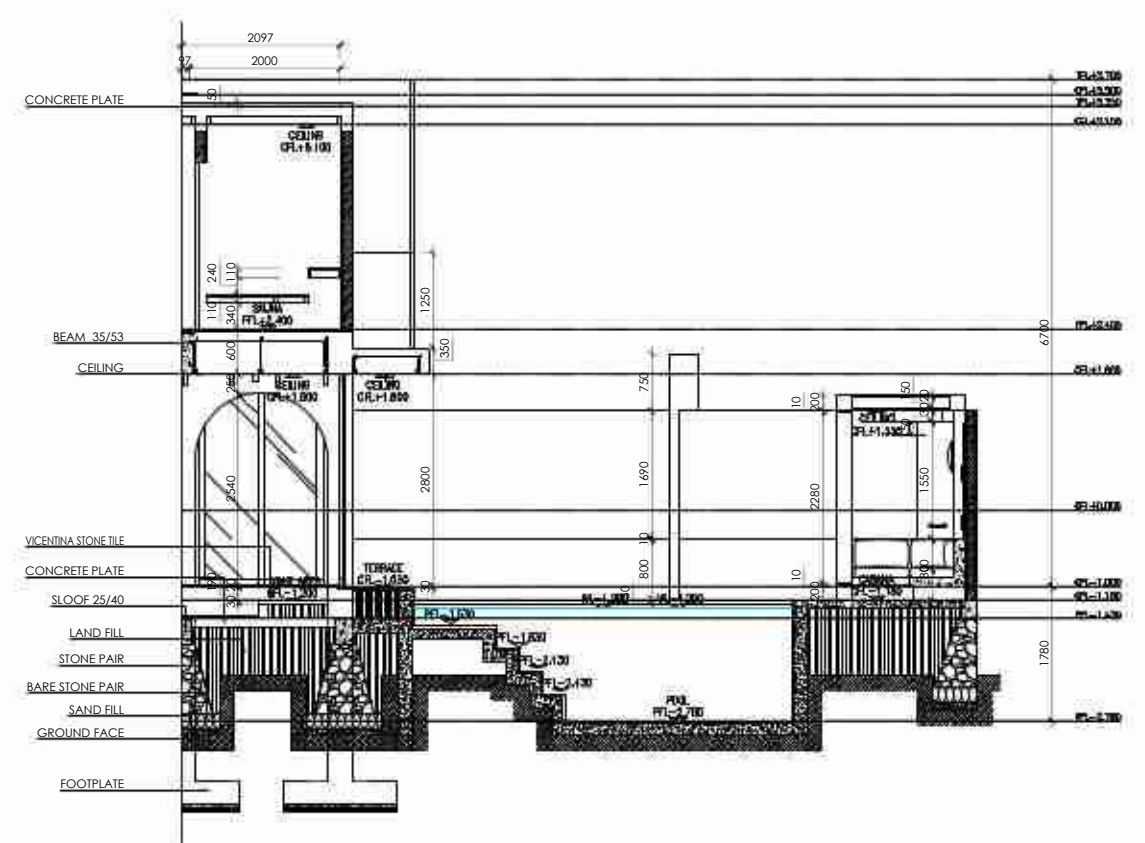
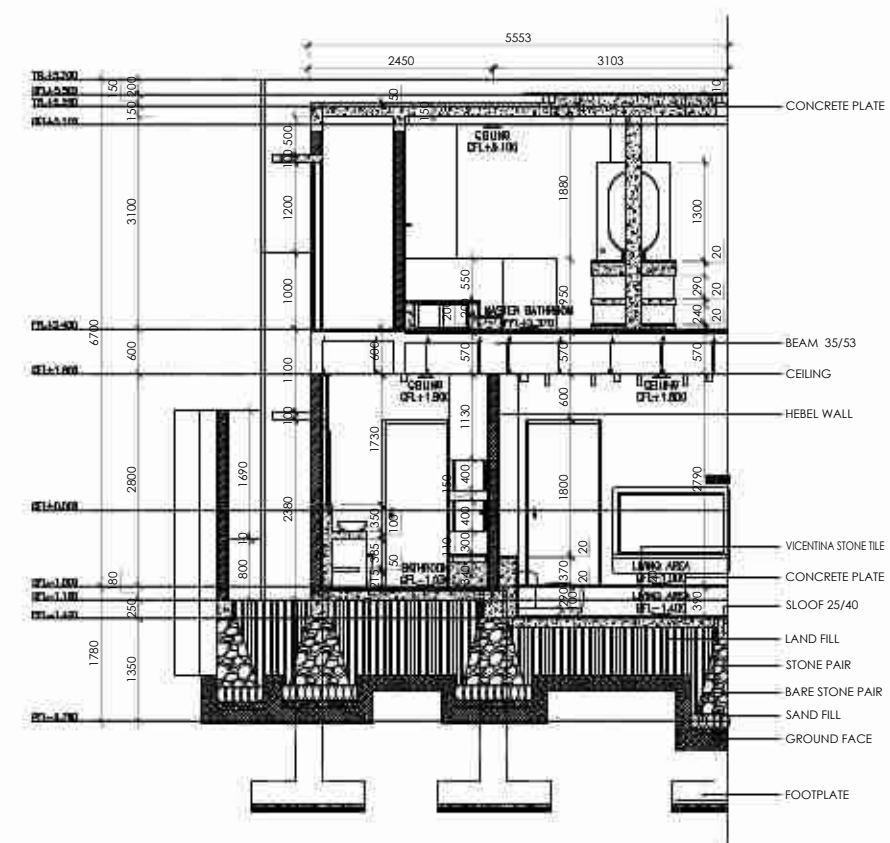
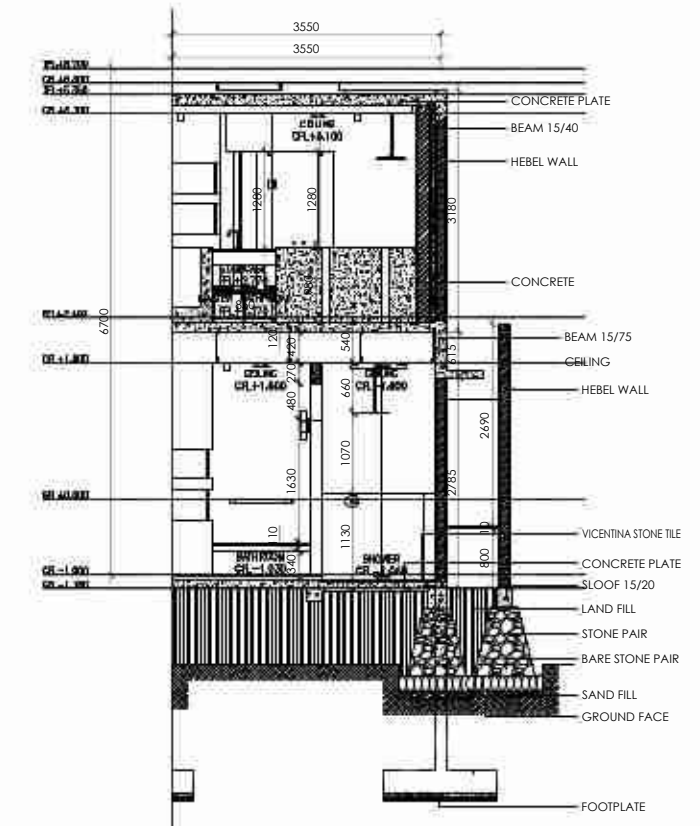
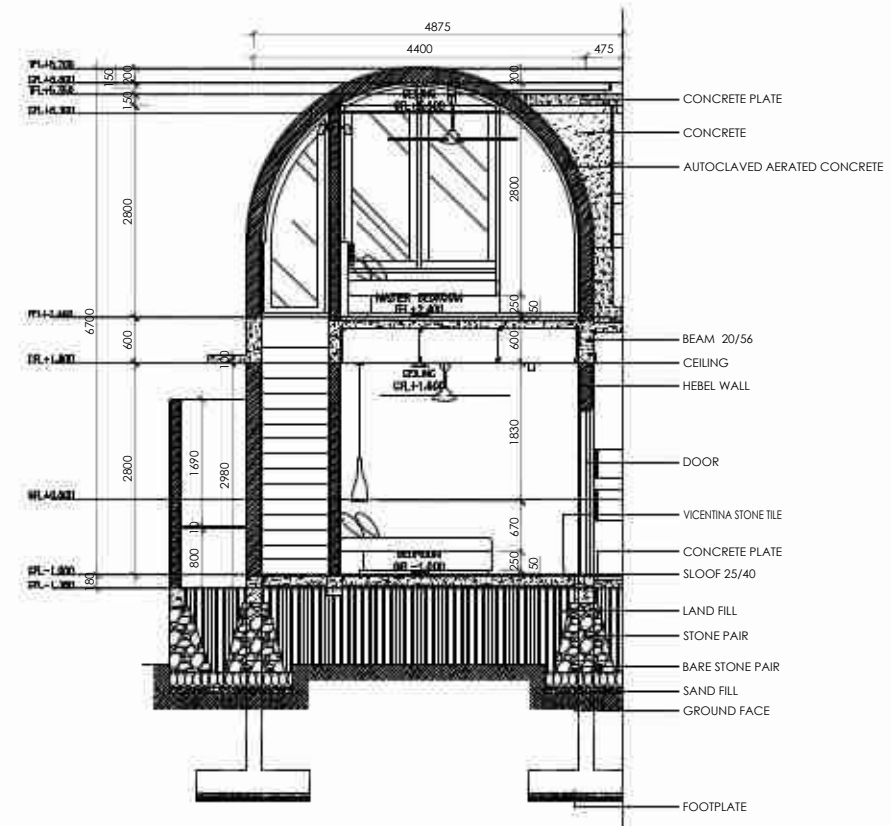

BLOW UP SECTION 2 VILLA B
Scale 1 : 100

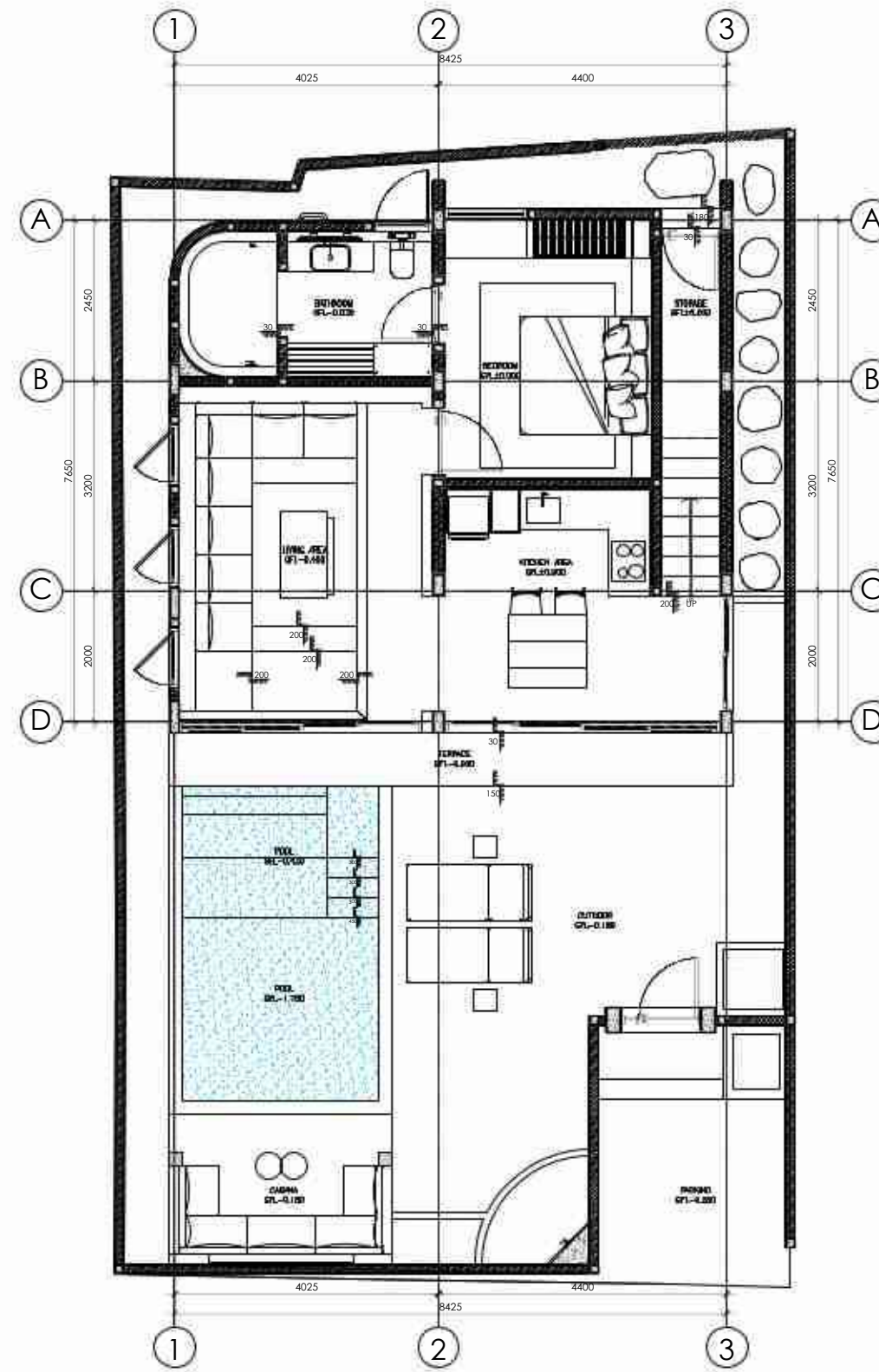

GROUND FLOOR PLAN VILLA C
Scale 1 : 100

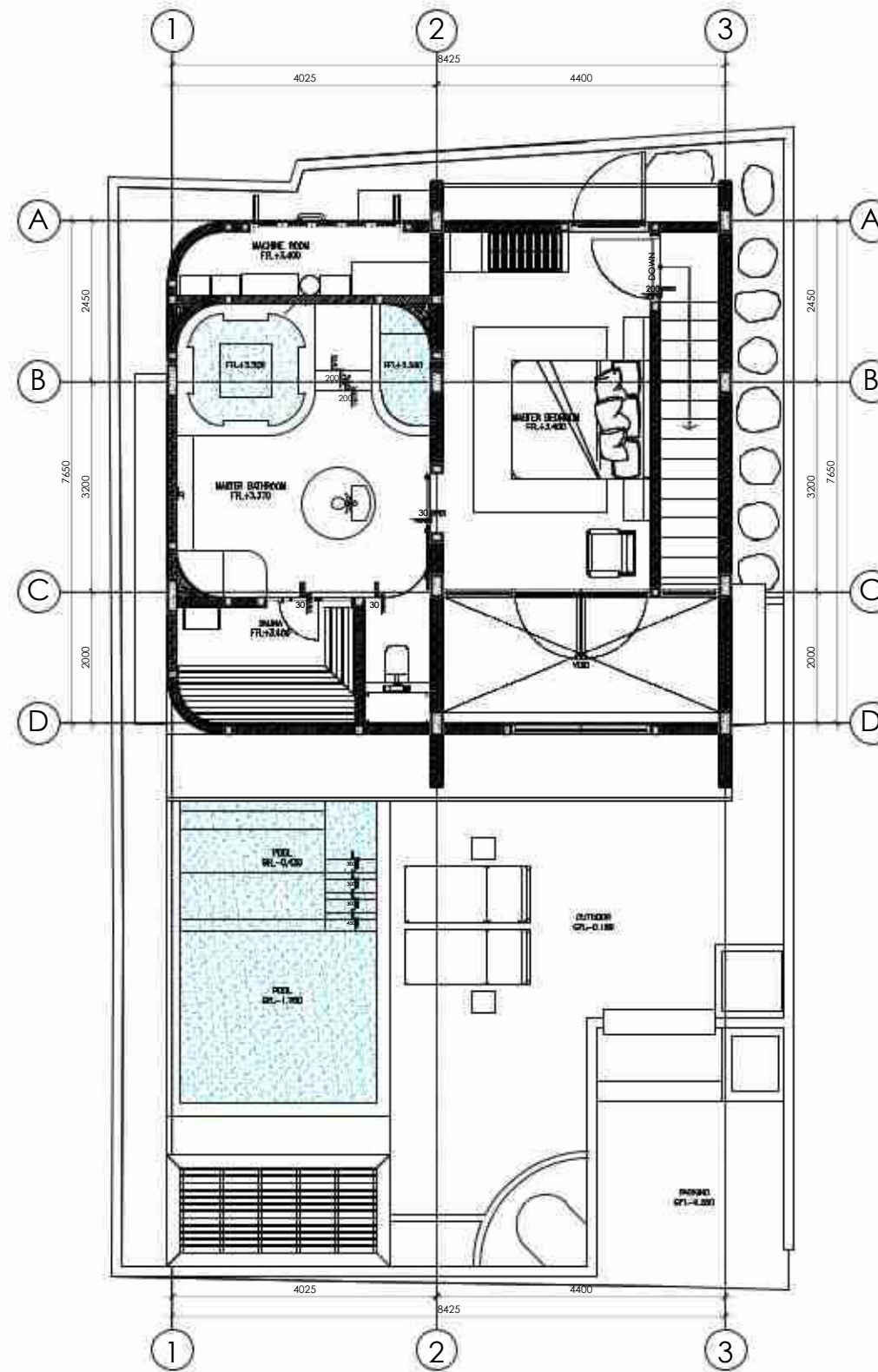

FIRST FLOOR PLAN VILLA C
Scale 1 : 100

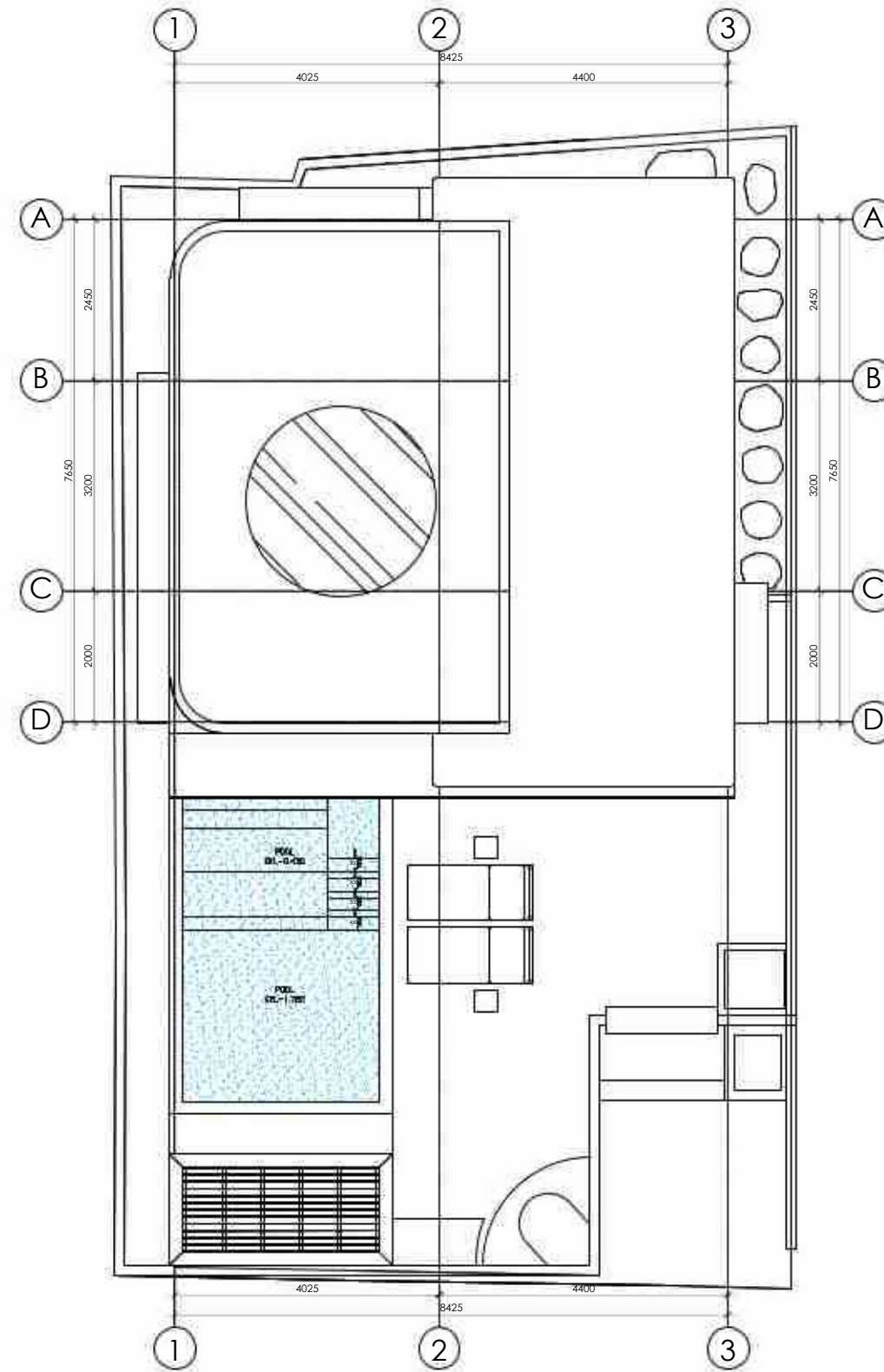

ROOF TOP PLAN VILLA C
Scale 1 : 100

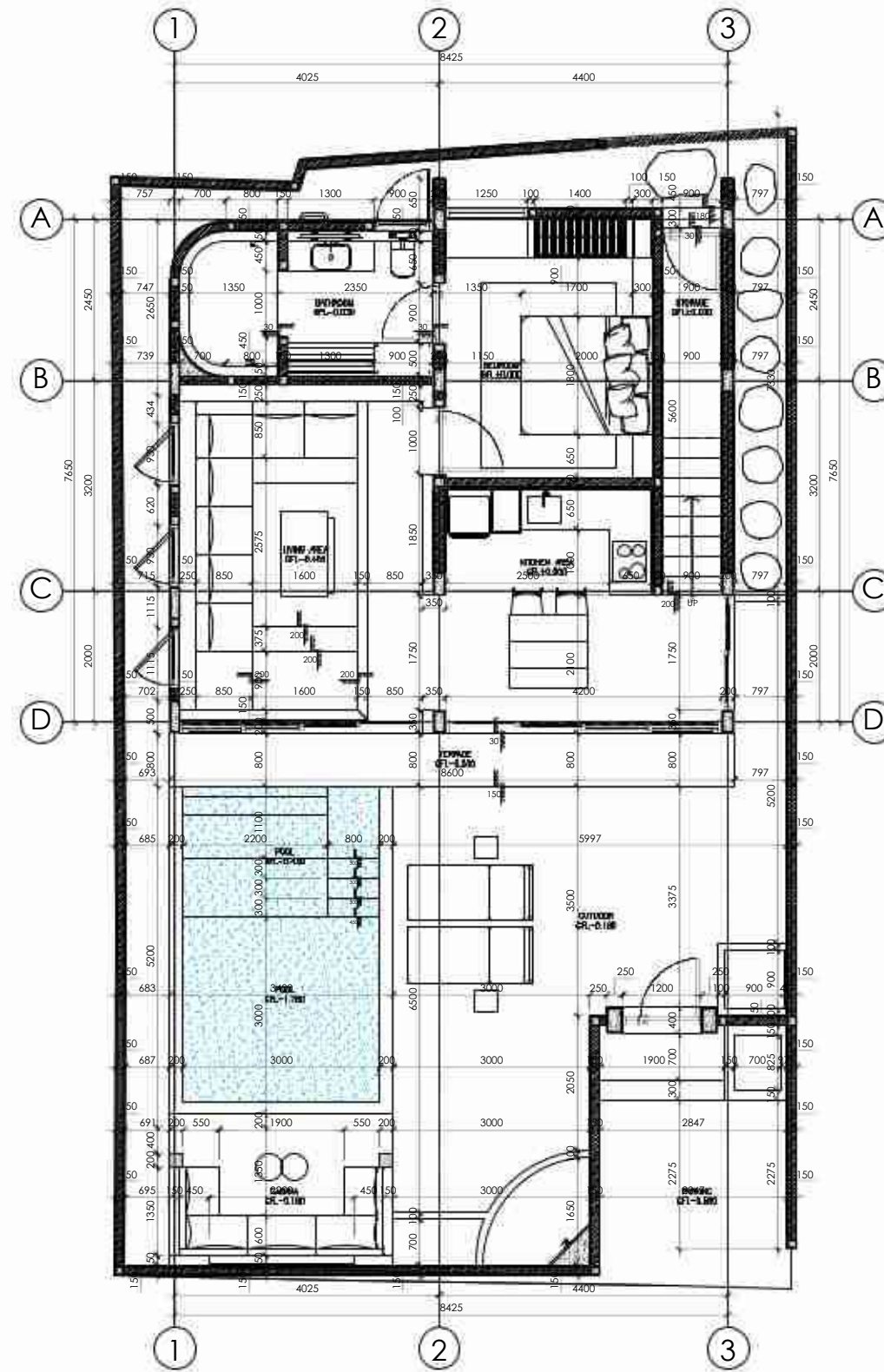

GROUND FLOOR DIMENSION PLAN VILLA C
Scale 1 : 100

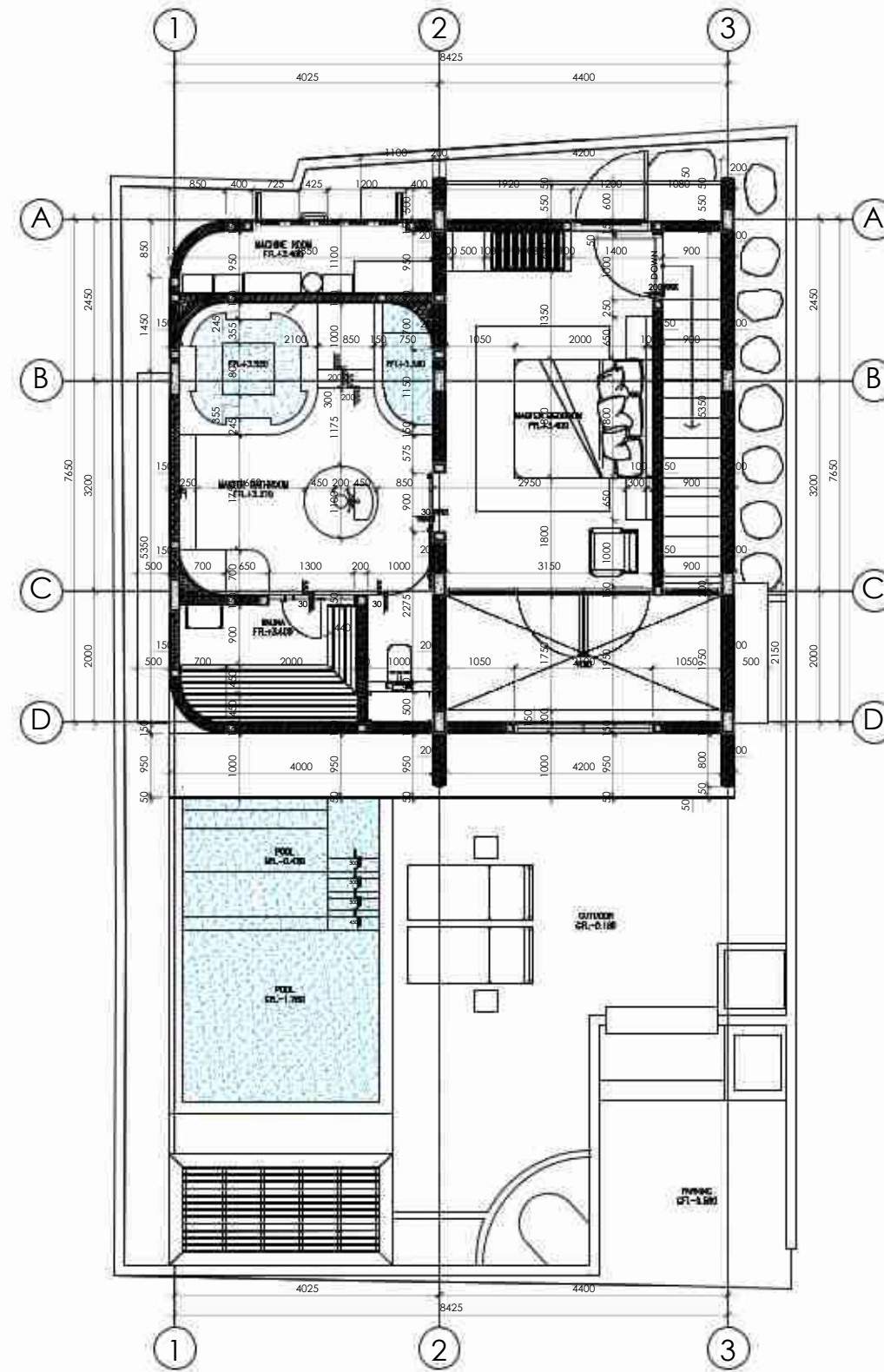

FIRST FLOOR DIMENSION PLAN VILLA C
Scale 1 : 100

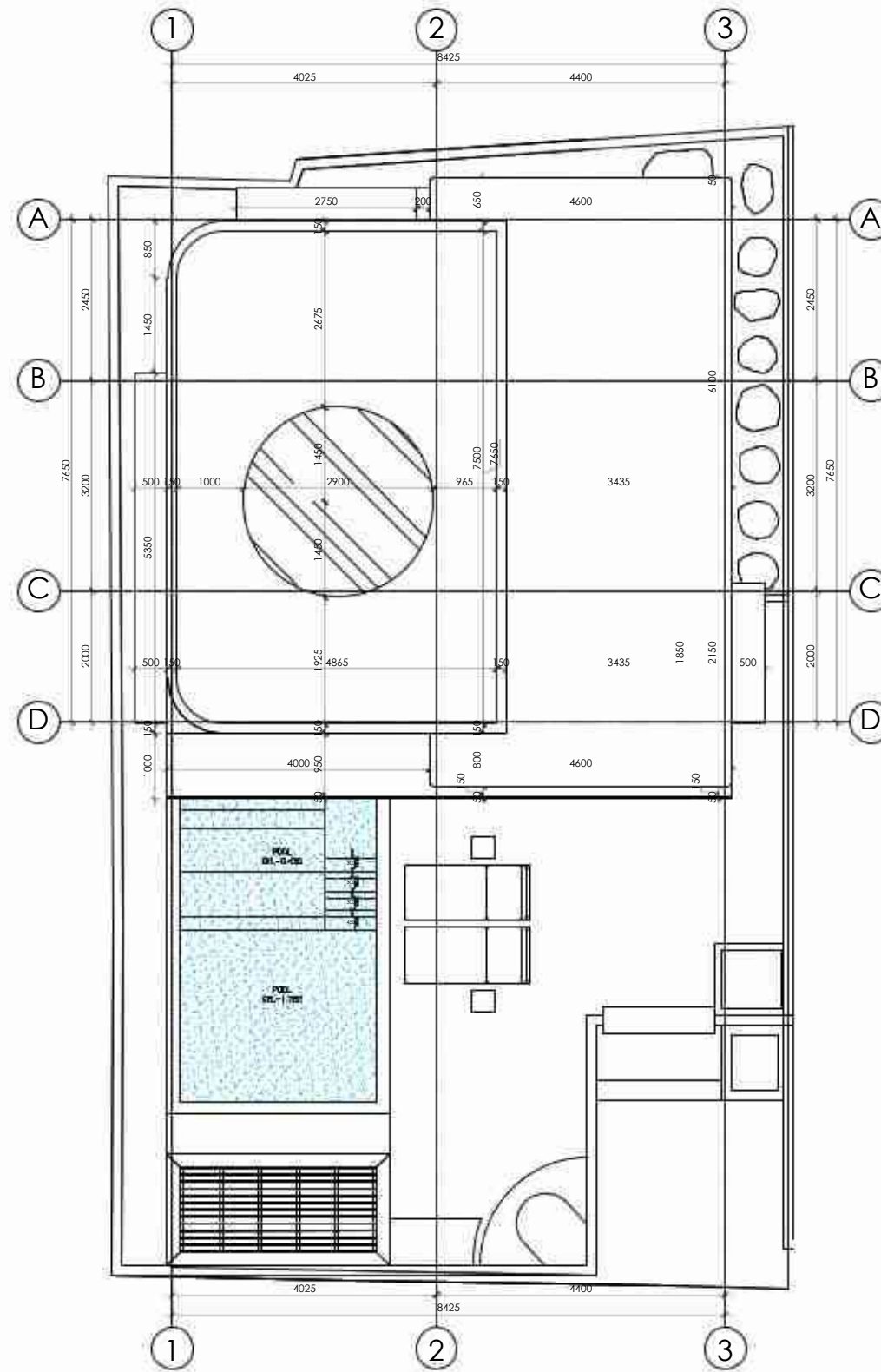

ROOF TOP DIMENSION PLAN VILLA C
Scale 1 : 100

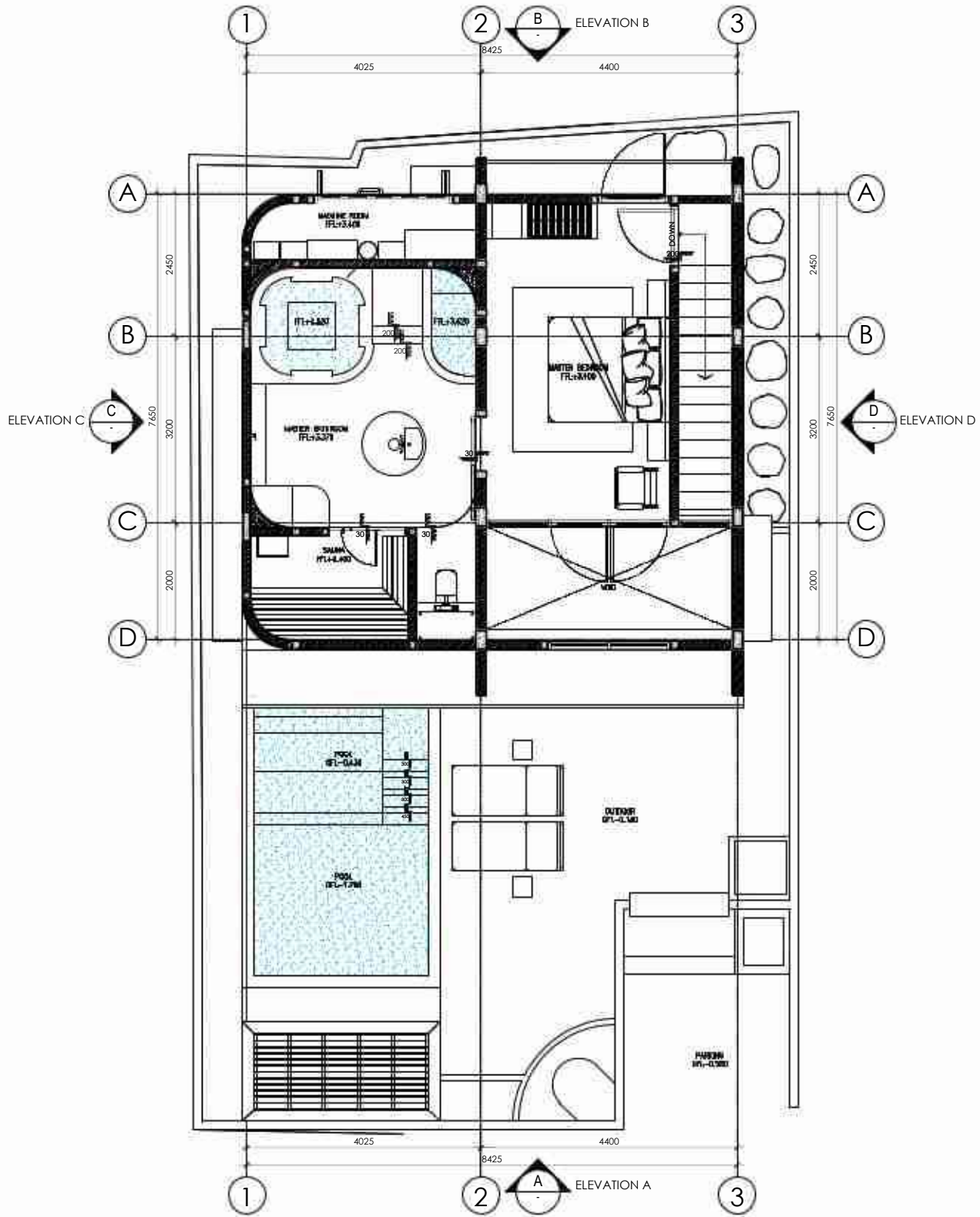
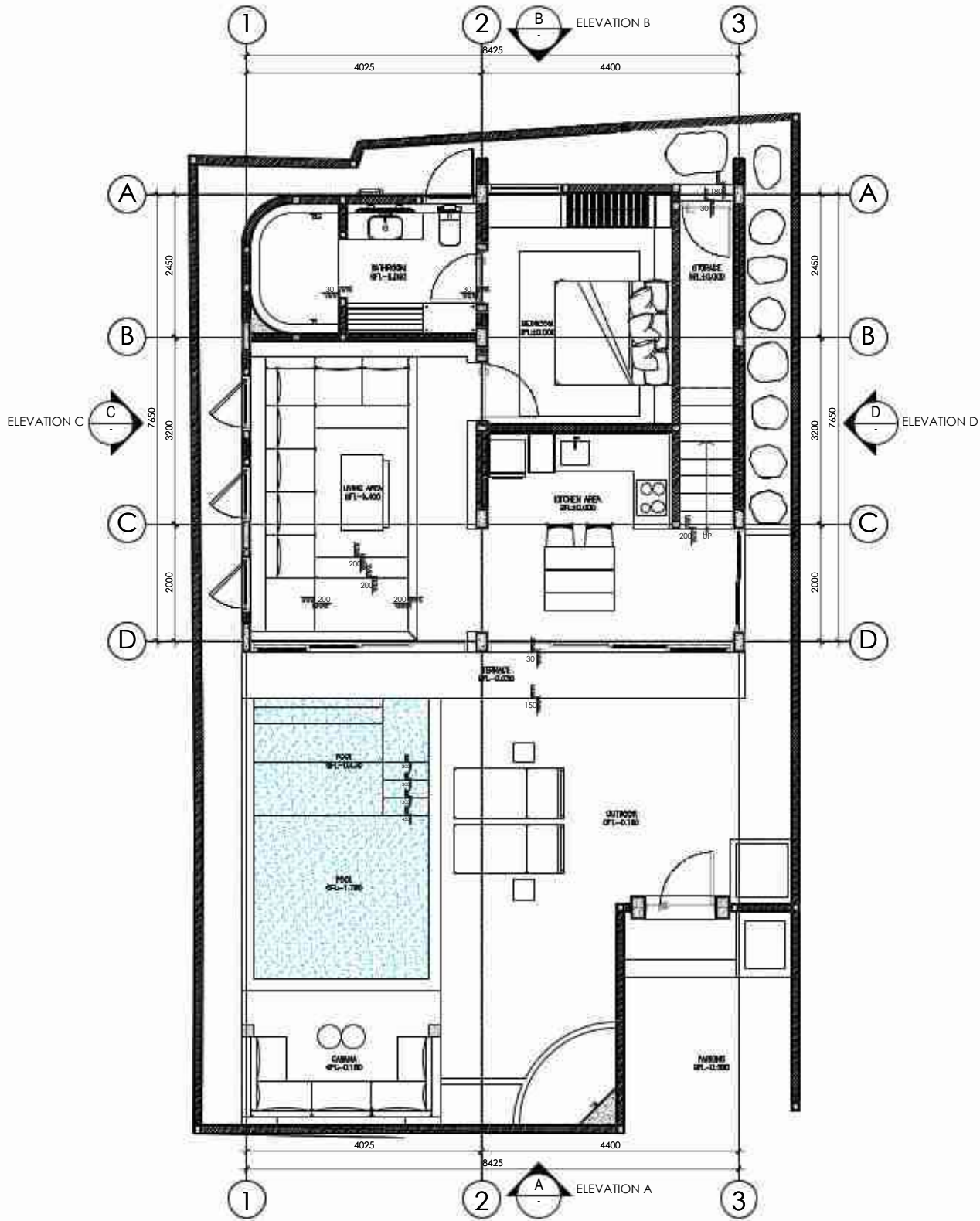

ELEVATION VILLA C
Scale 1 : 100

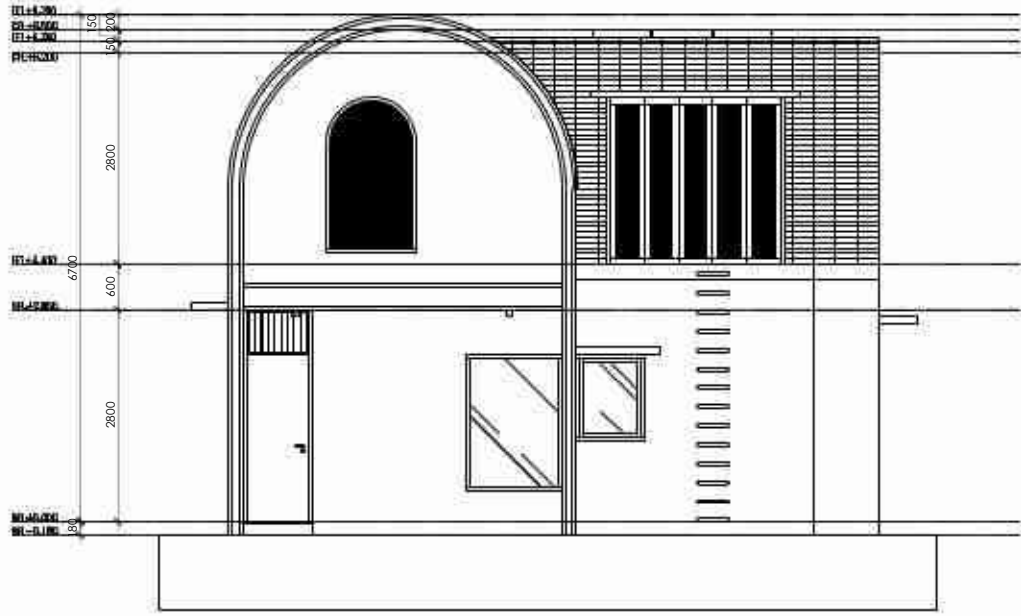
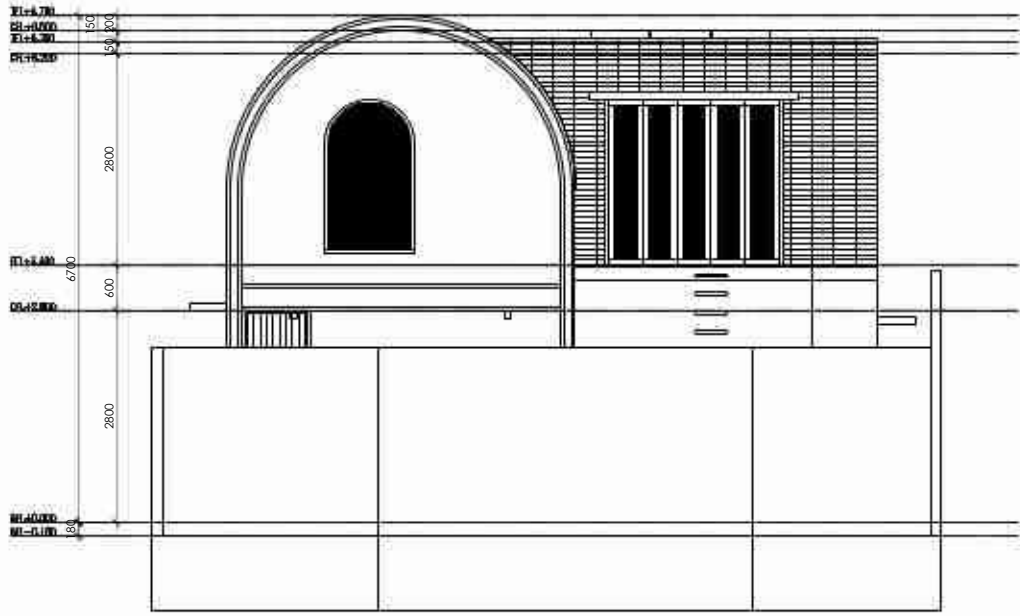

ELEVATION B-B VILLA C
Scale 1 : 100

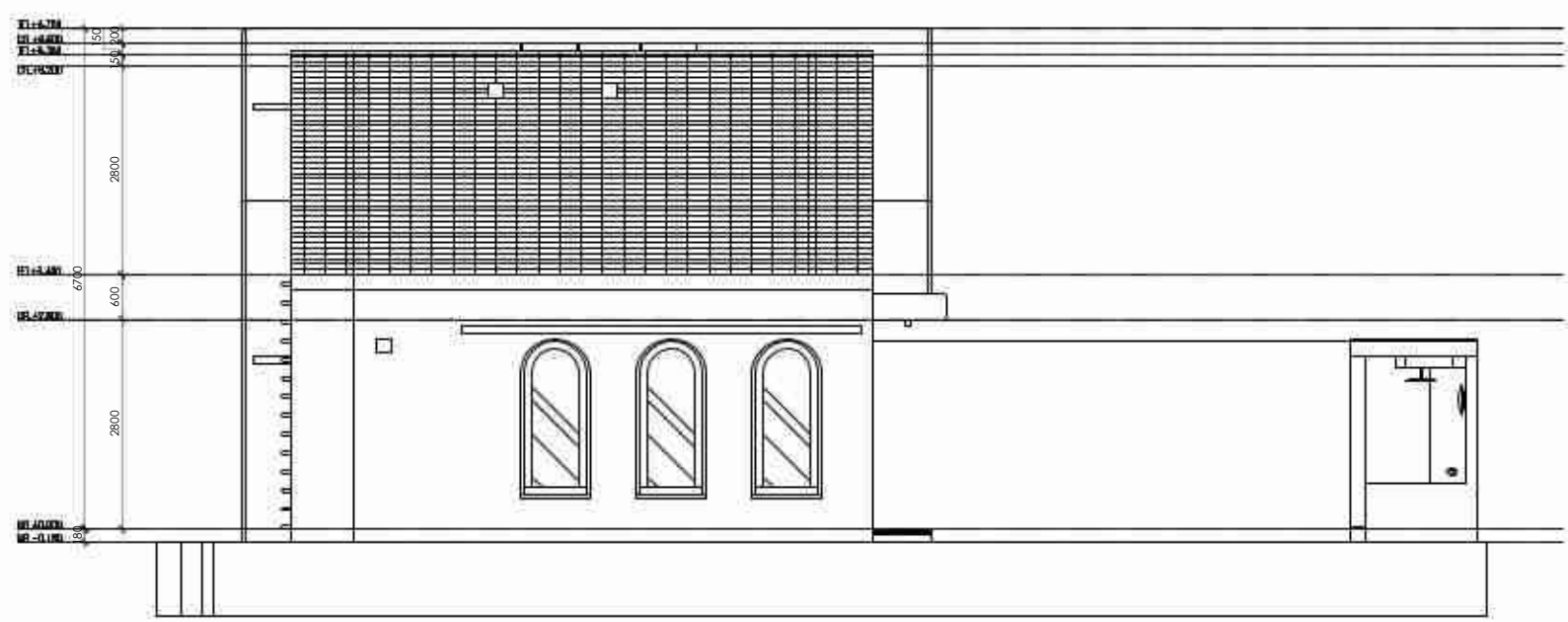
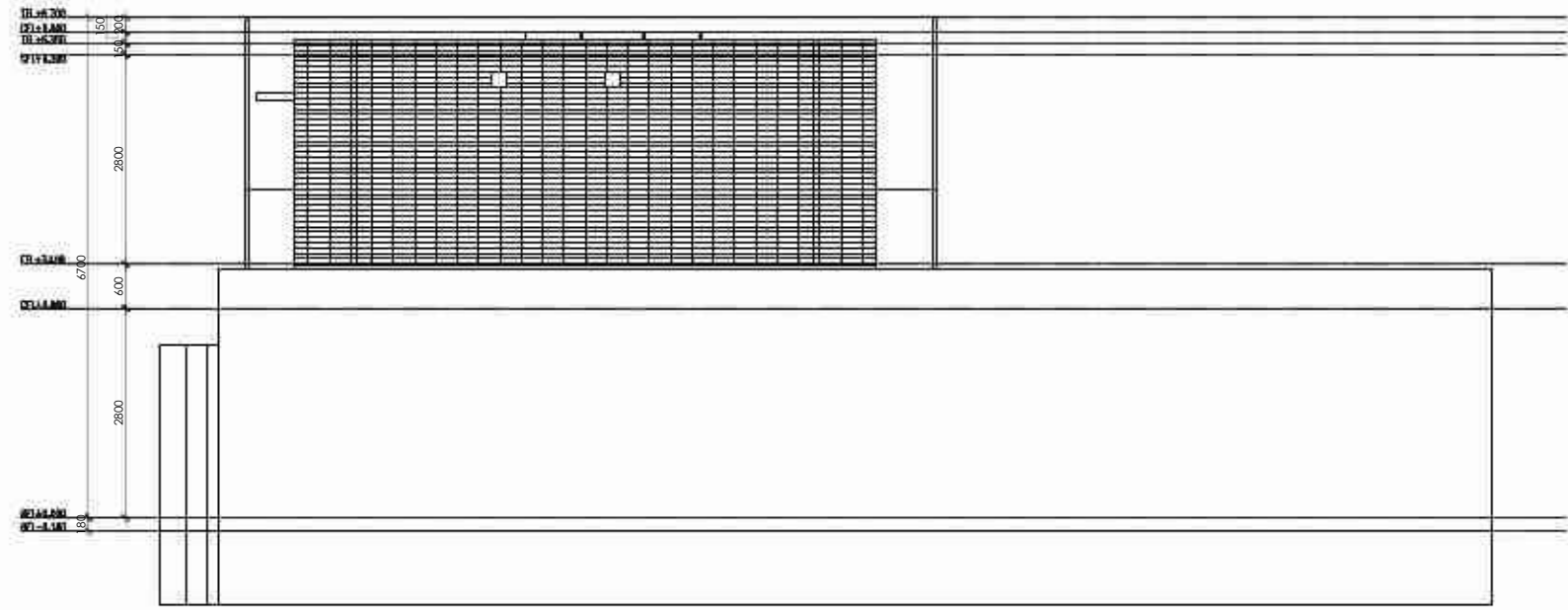

ELEVATION C-C SITE C
Scale 1 : 100

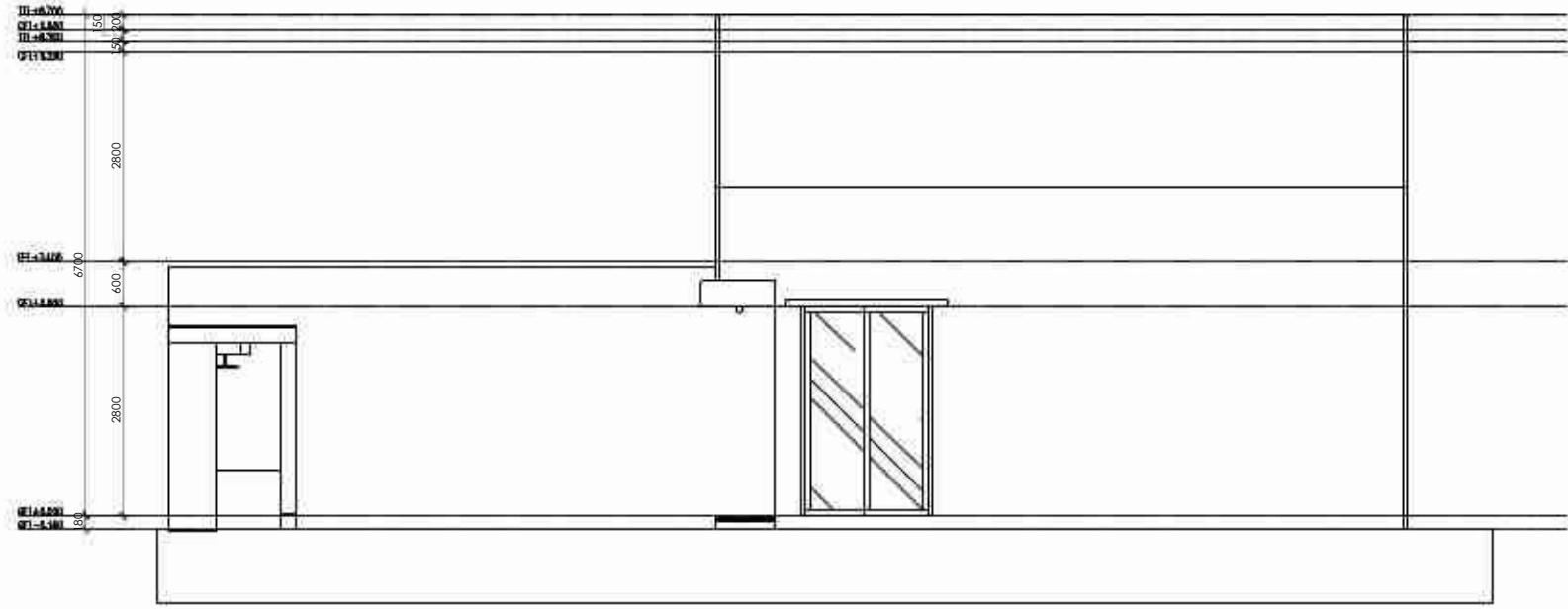
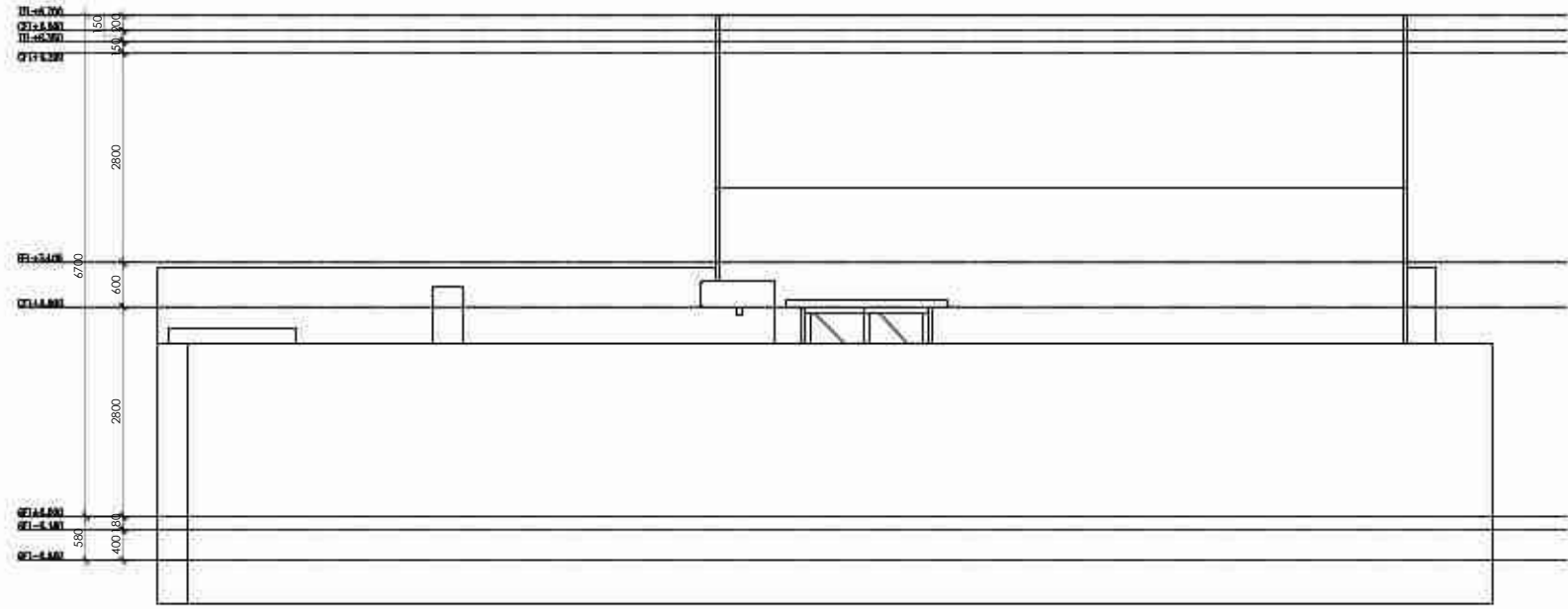

ELEVATION D-D VILLA C
Scale 1 : 100

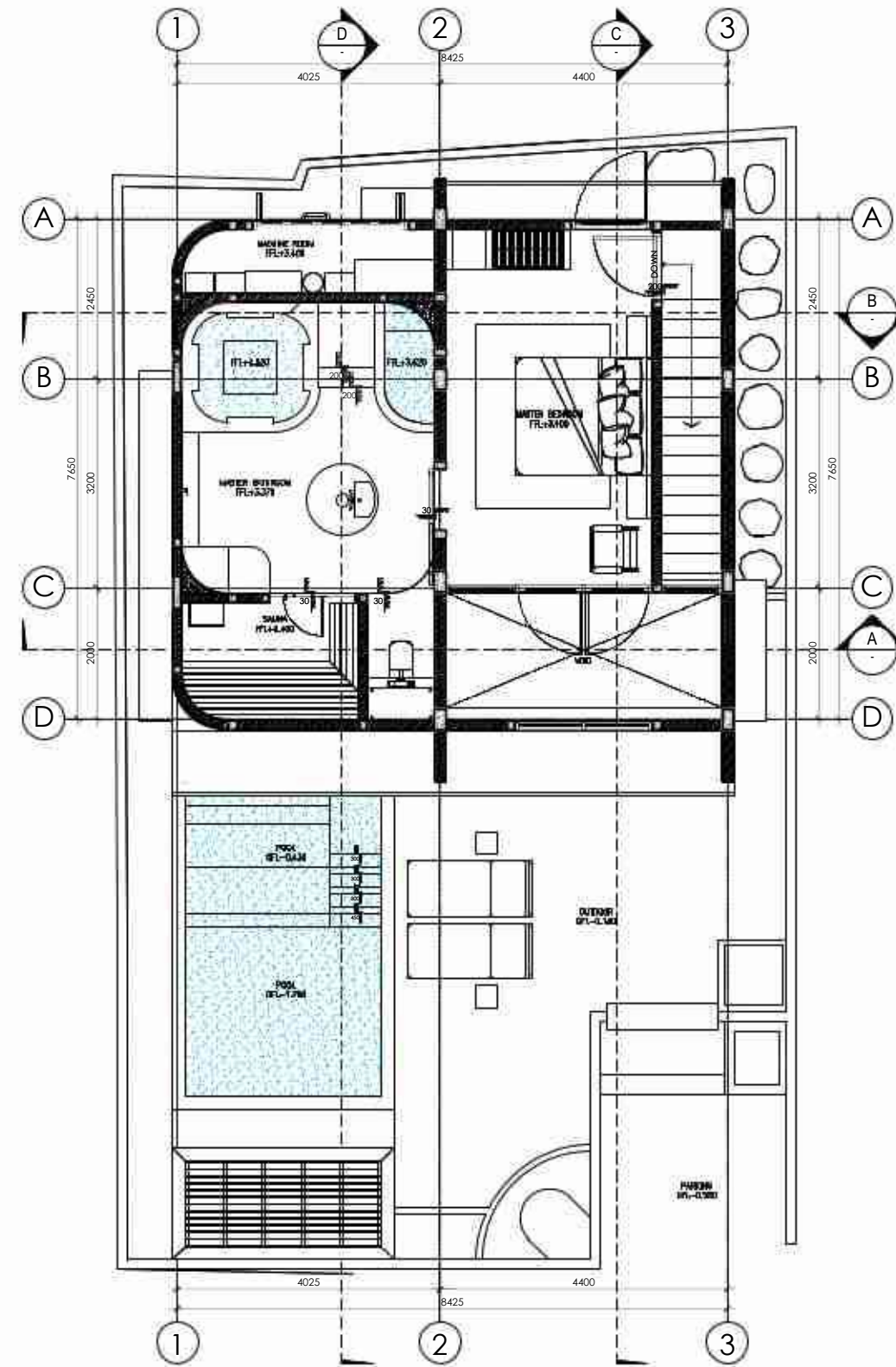
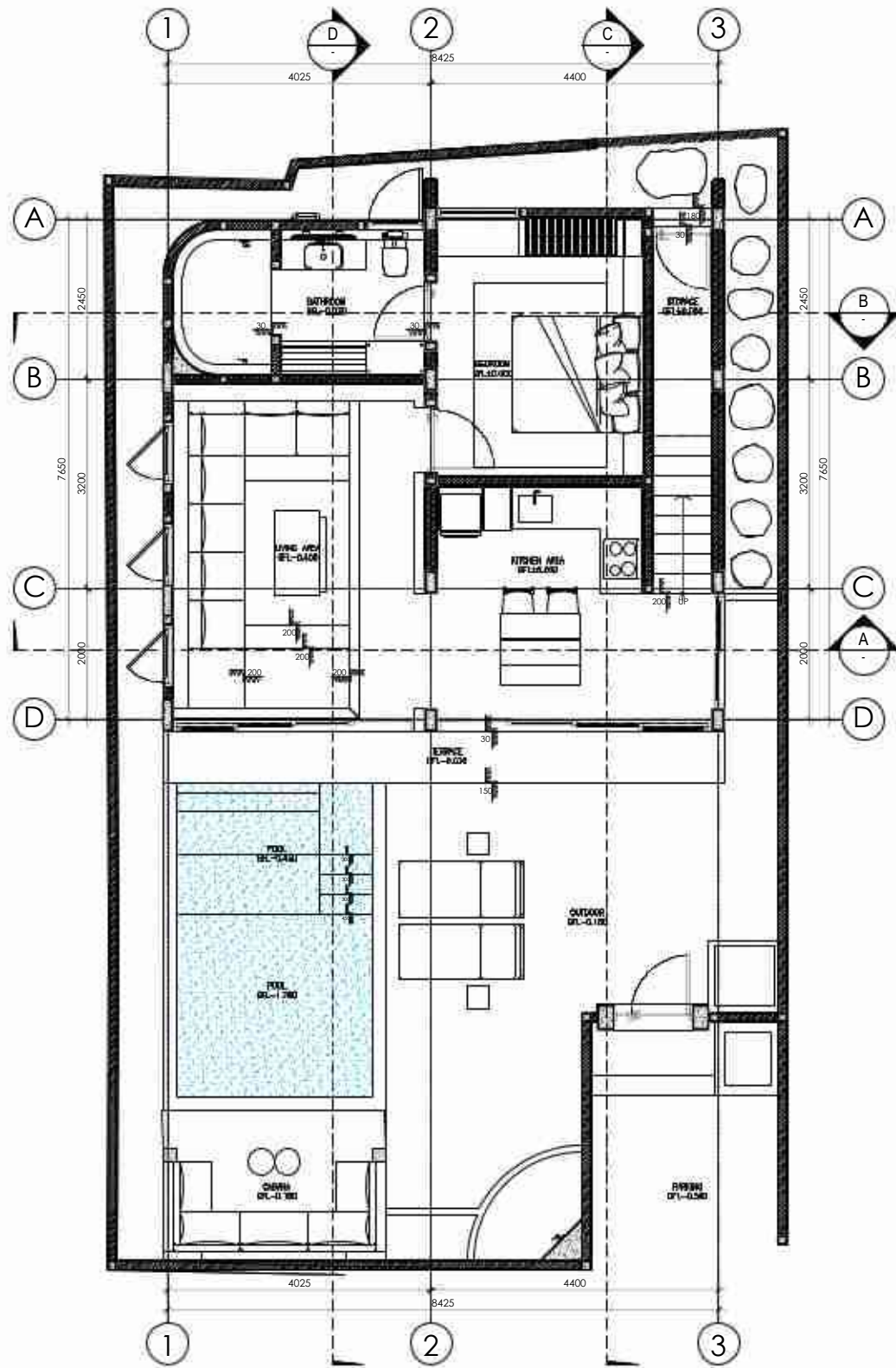

SECTION VILLA C
Scale 1 : 100

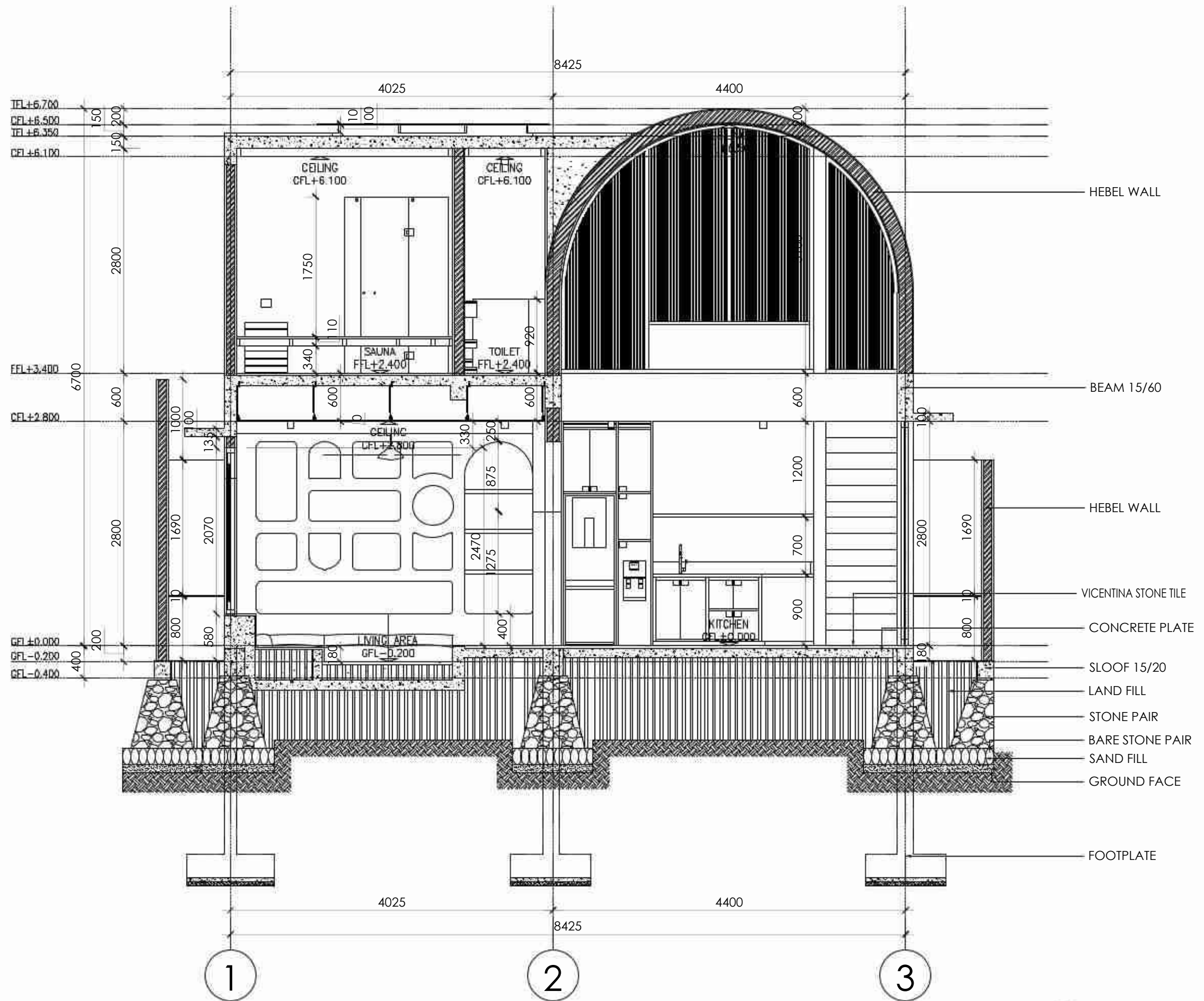

SECTION A-A VILLA C
Scale 1 : 50

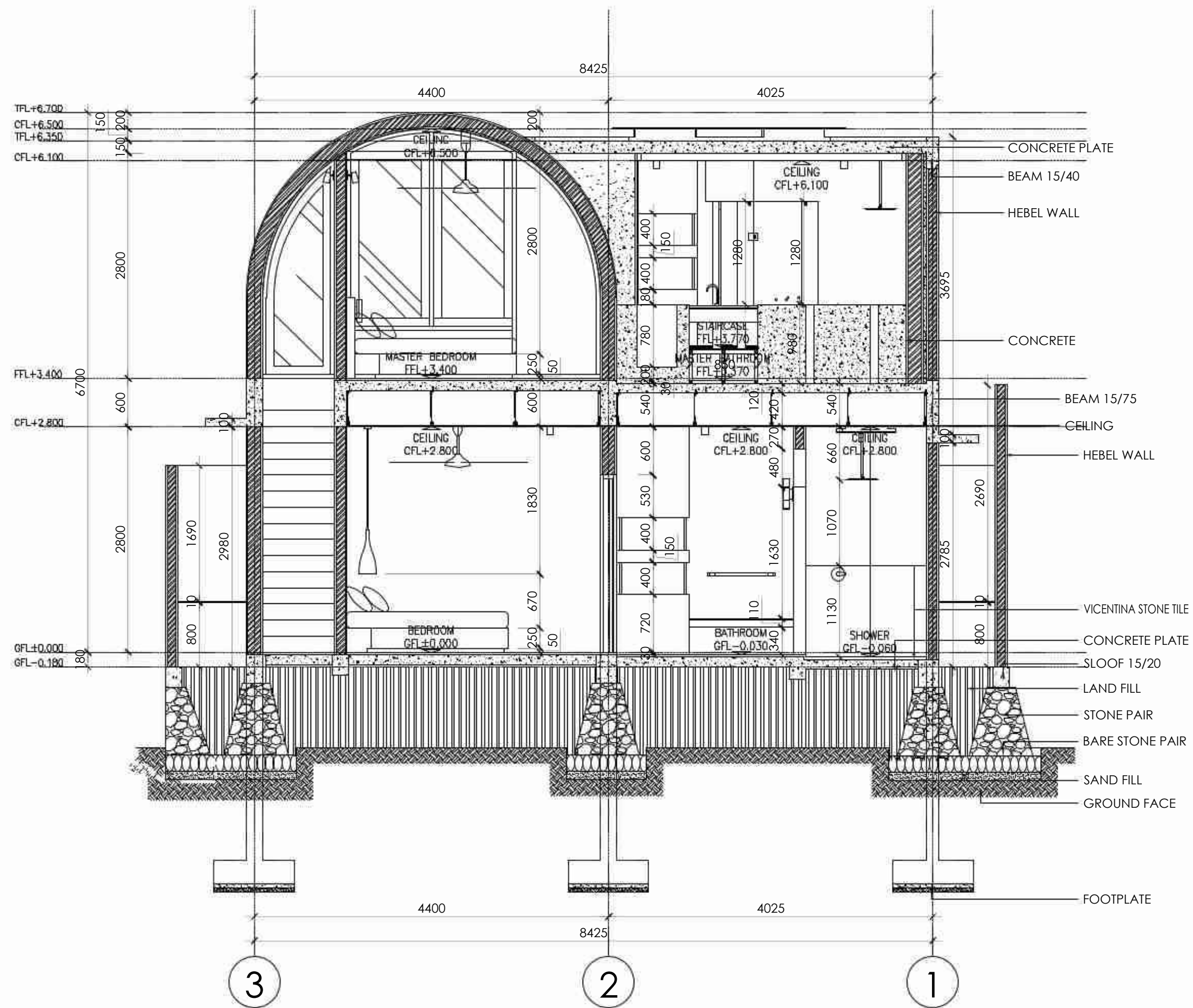

SECTION B-B VILLA C
Scale 1 : 50

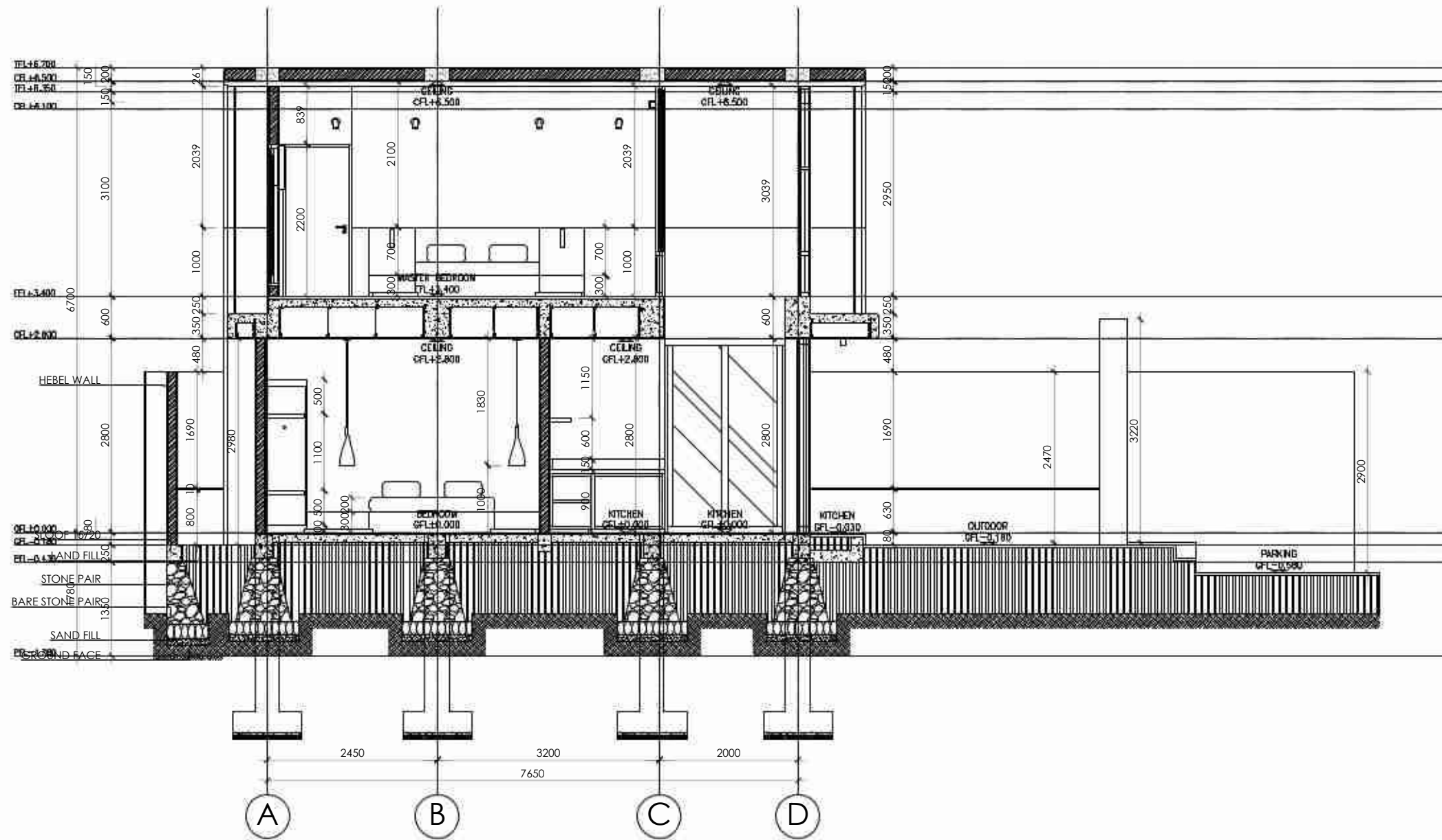

SECTION C-C VILLA C
Scale 1 : 75

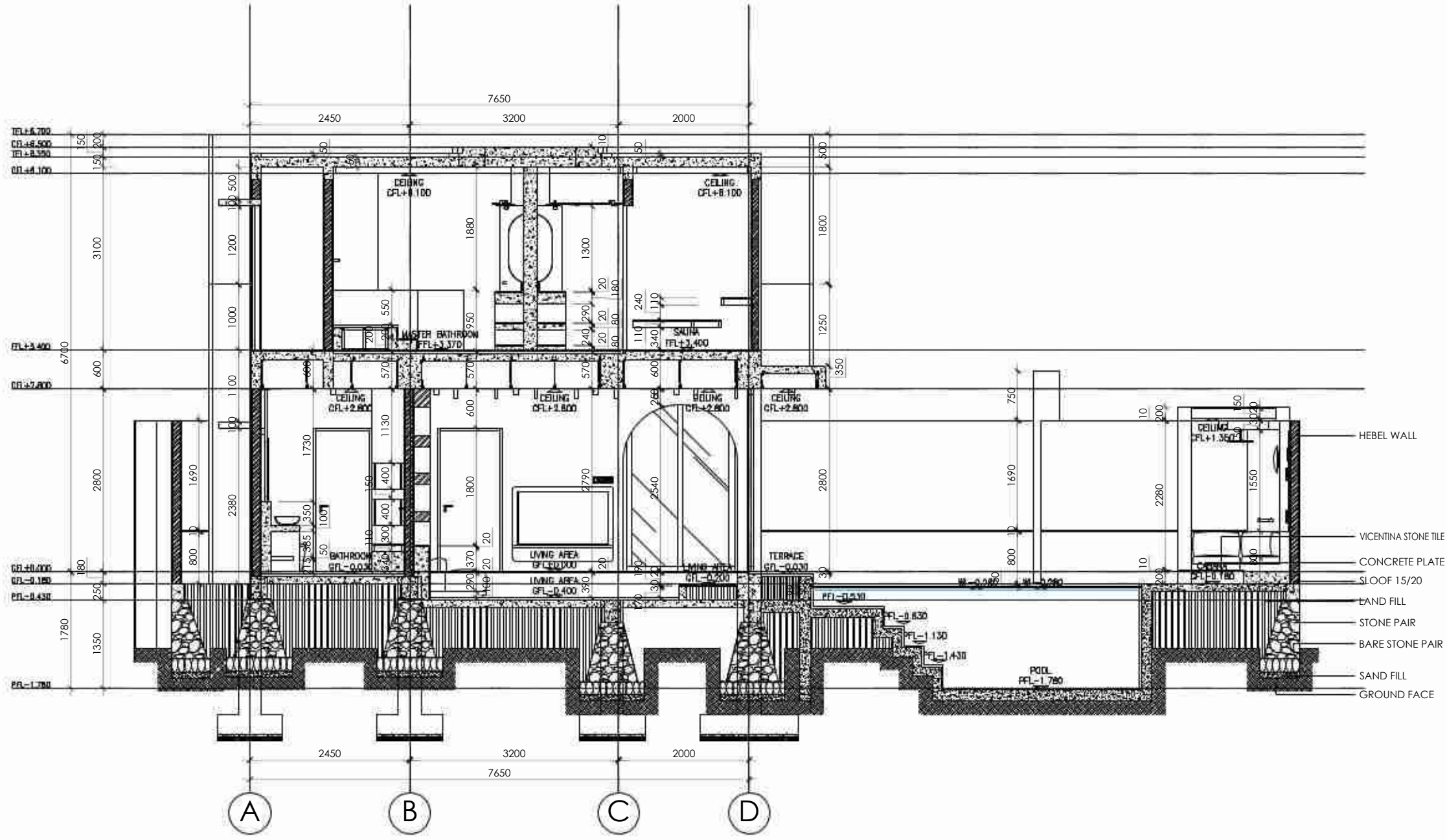

SECTION D-D VILLA C
 Scale 1 : 75

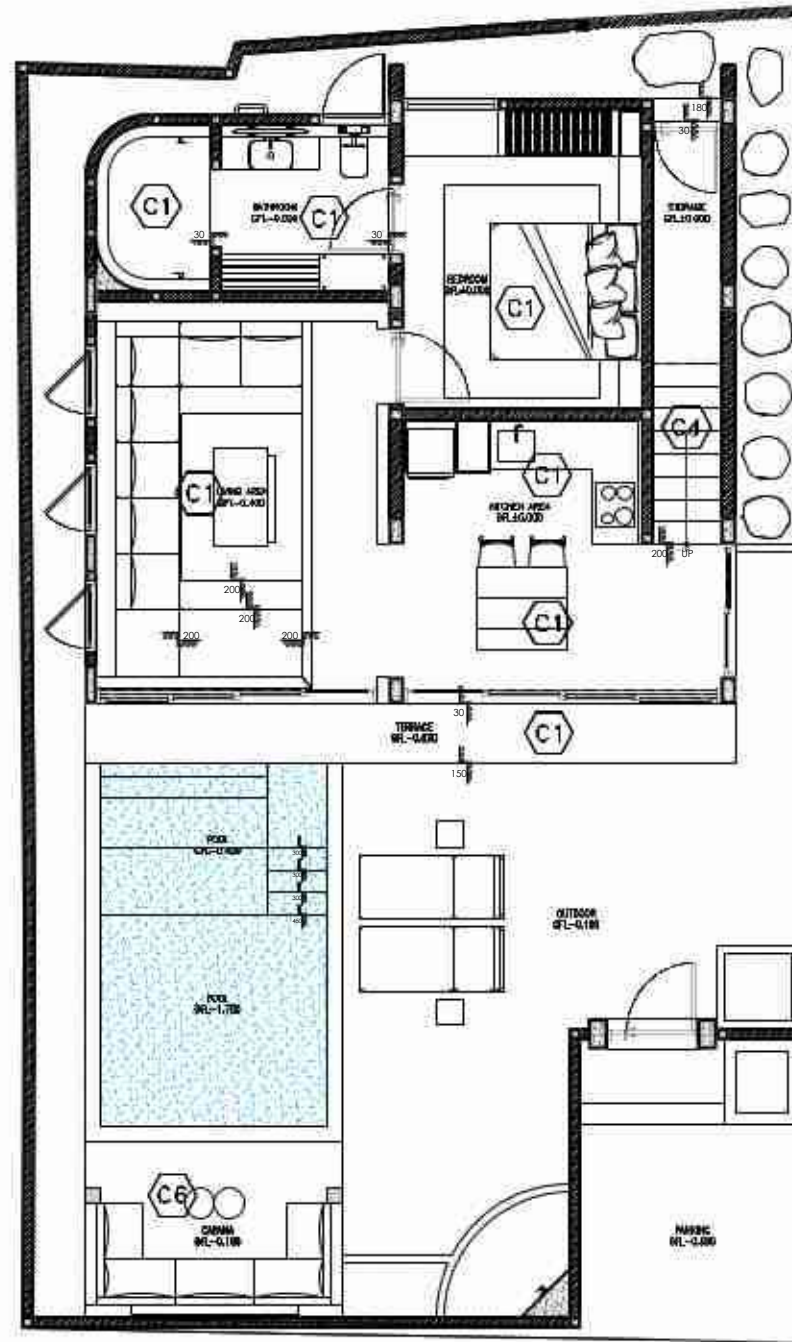

KETERANGAN	
C1	CONCRETE BARE TEXTURE HAZELNUT PAINTING COLOR
C2	MIDVIC MARBLE TILE
C3	CONCRETE BARE TEXTURE GREY COLOR
C4	CONCRETE BARE TEXTURE PREFER TO MAKE
C5	CONCRETE BARE TEXTURE PREFER TO MAKE
C6	TEAK WOOD FIN BRAK MALIUT
C7	SPECIAL BRICKS
C8	TERTULUH DAPUR

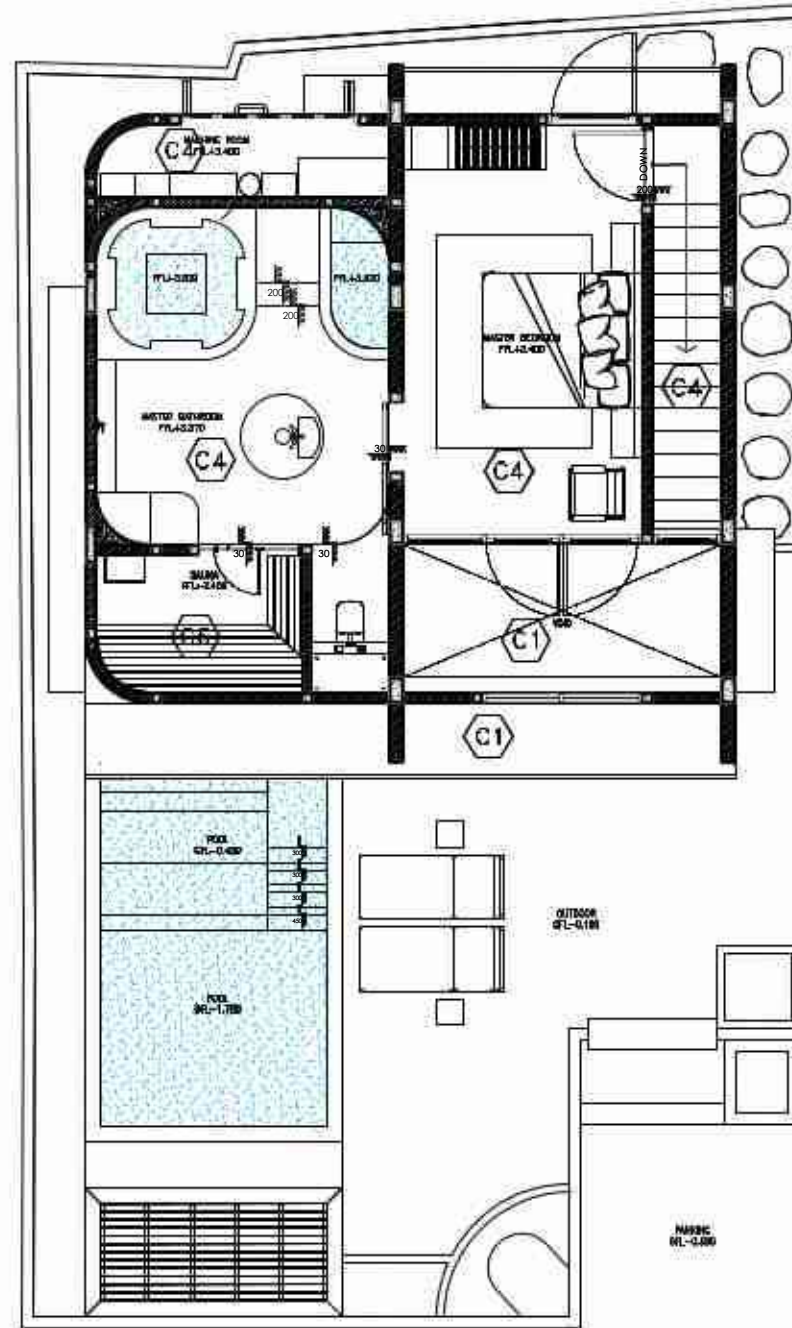

KETERANGAN	
C1	CONCRETE BARE TEXTURE HAZIMIT WHITE COLOR
C2	MOSAIC MARBEL TILE
C3	CONCRETE BARE TEXTURE GREY COLOR
C4	CONCRETE BARE TEXTURE PROFER TO INAGE
C5	CONCRETE BARE TEXTURE PROFER TO INAGE
C6	TEAK 1000 IN DARK WASHED
C7	SPECIAL IRONS
C8	Terrazzo Surface

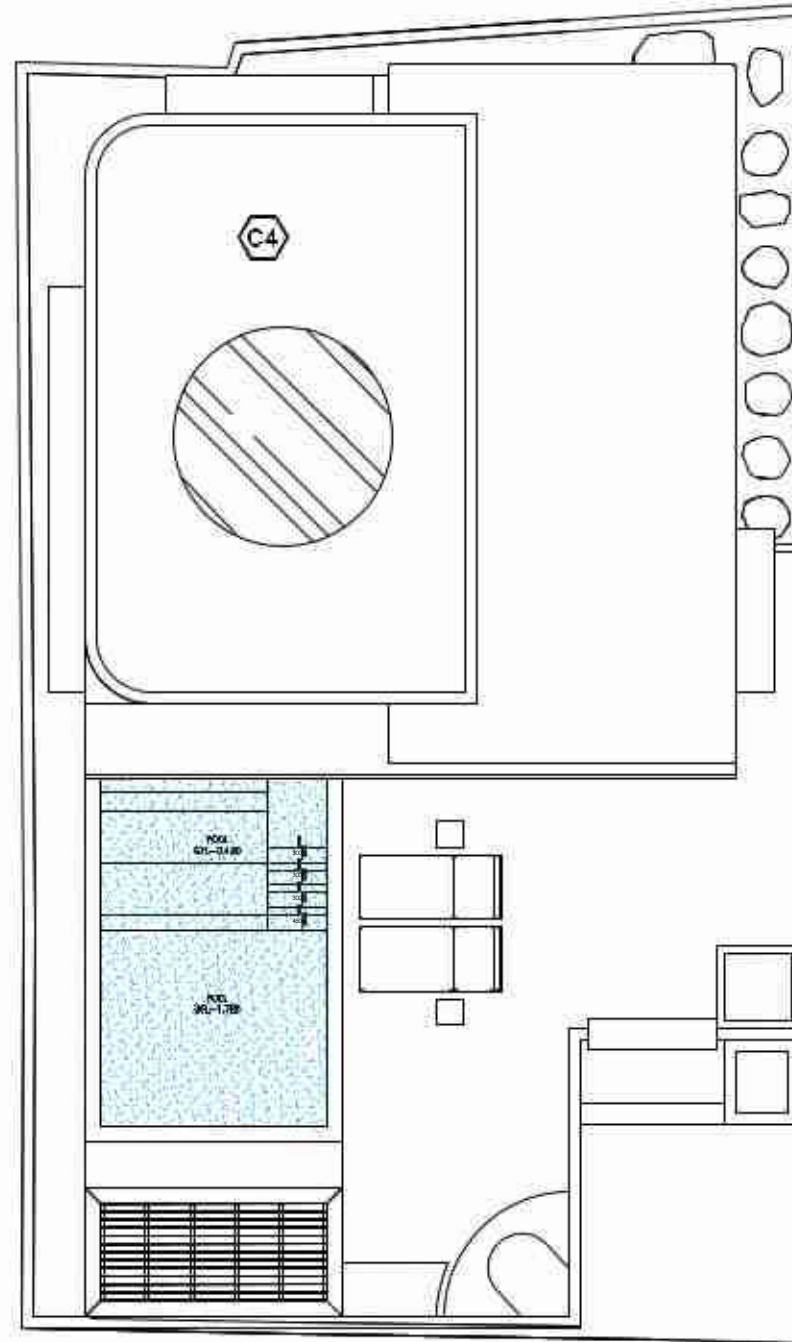

KETERANGAN	
(C1)	CONCRETE BARE TEXTURE HAZENIT PINKISH COLOR
(C2)	MOSAIC MARBLE TILE
(C3)	CONCRETE BARE TEXTURE GREY COLOR
(C4)	CONCRETE BARE TEXTURE PROFER TO INAGE
(C5)	CONCRETE BARE TEXTURE PROFER TO INAGE
(C6)	TEAK 1000 IN DARK VARNISH
(C7)	SPECIAL IRONS
(C8)	Terrazzo Surface

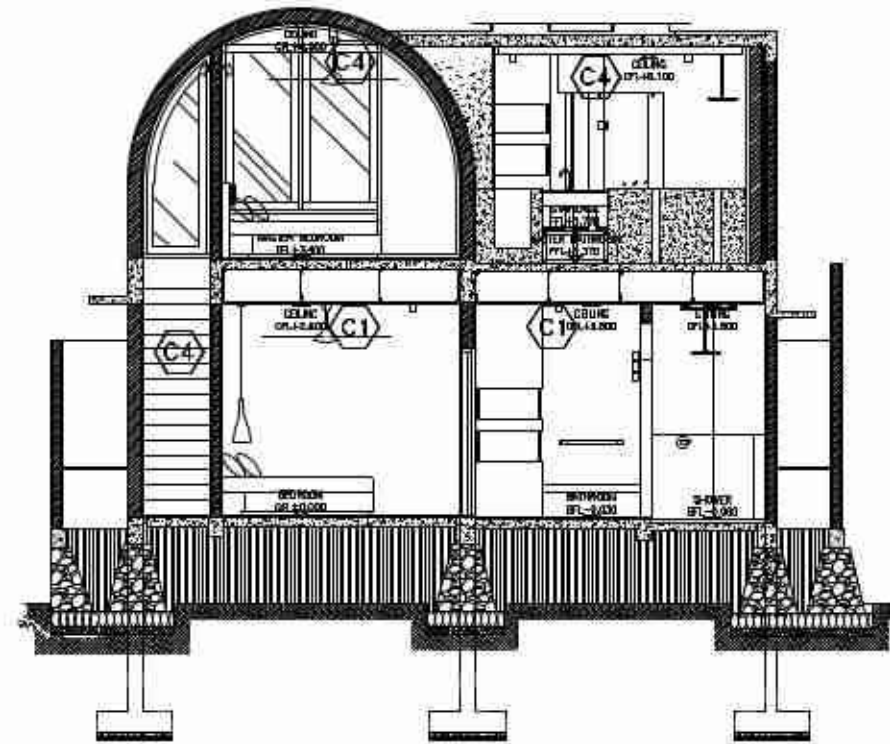
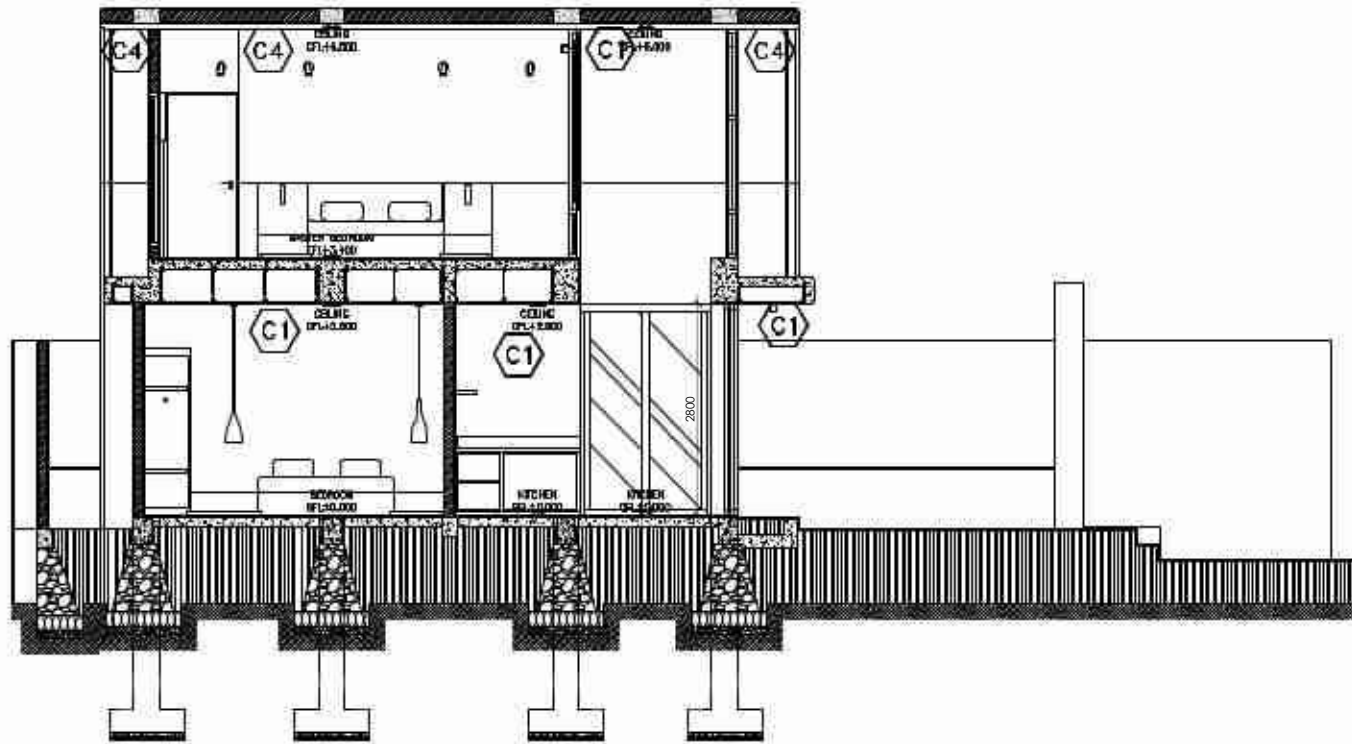
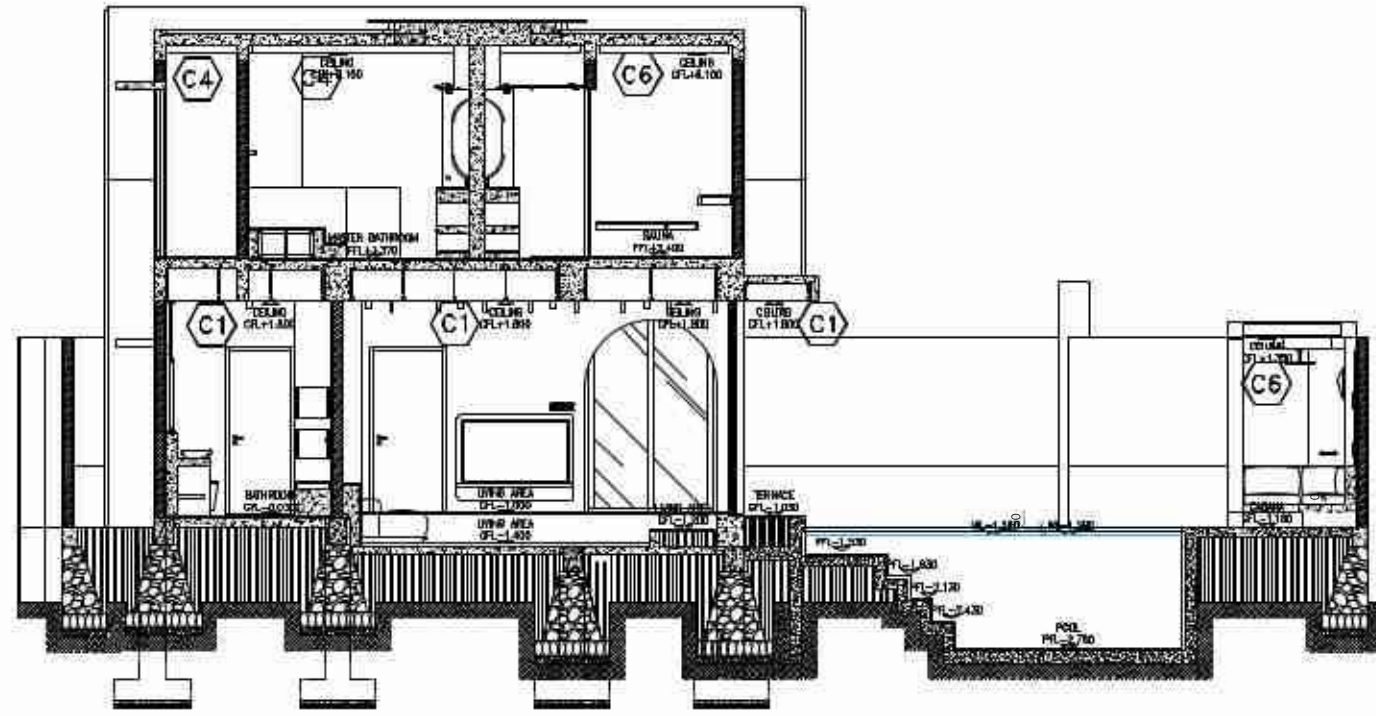
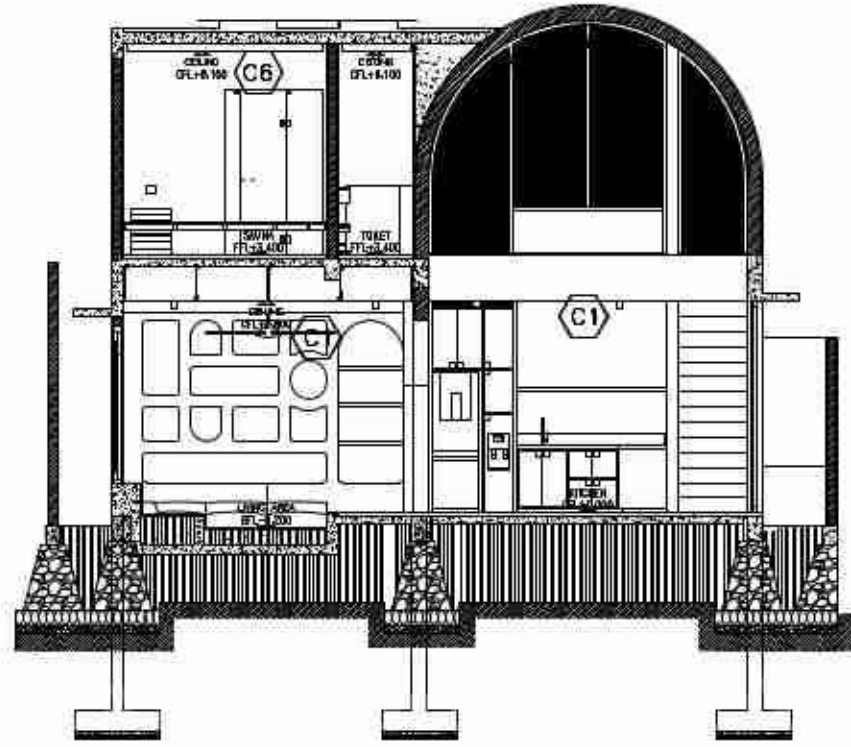

KETERANGAN

(C1)	CONCRETE BARE TEXTURE HAZELNUT PANTONE COLOR
(C2)	MIXING MARBLE TILE
(C3)	CONCRETE BARE TEXTURE GREY GILOR
(C4)	CONCRETE BARE TEXTURE PREFER TO IMAGE
(C5)	CONCRETE BARE TEXTURE PREFER TO IMAGE
(C6)	TEAK WOOD FIN DARK WAKAIT
(C7)	SPECIAL FINISHES
(C8)	TERRAZZO SURFACE

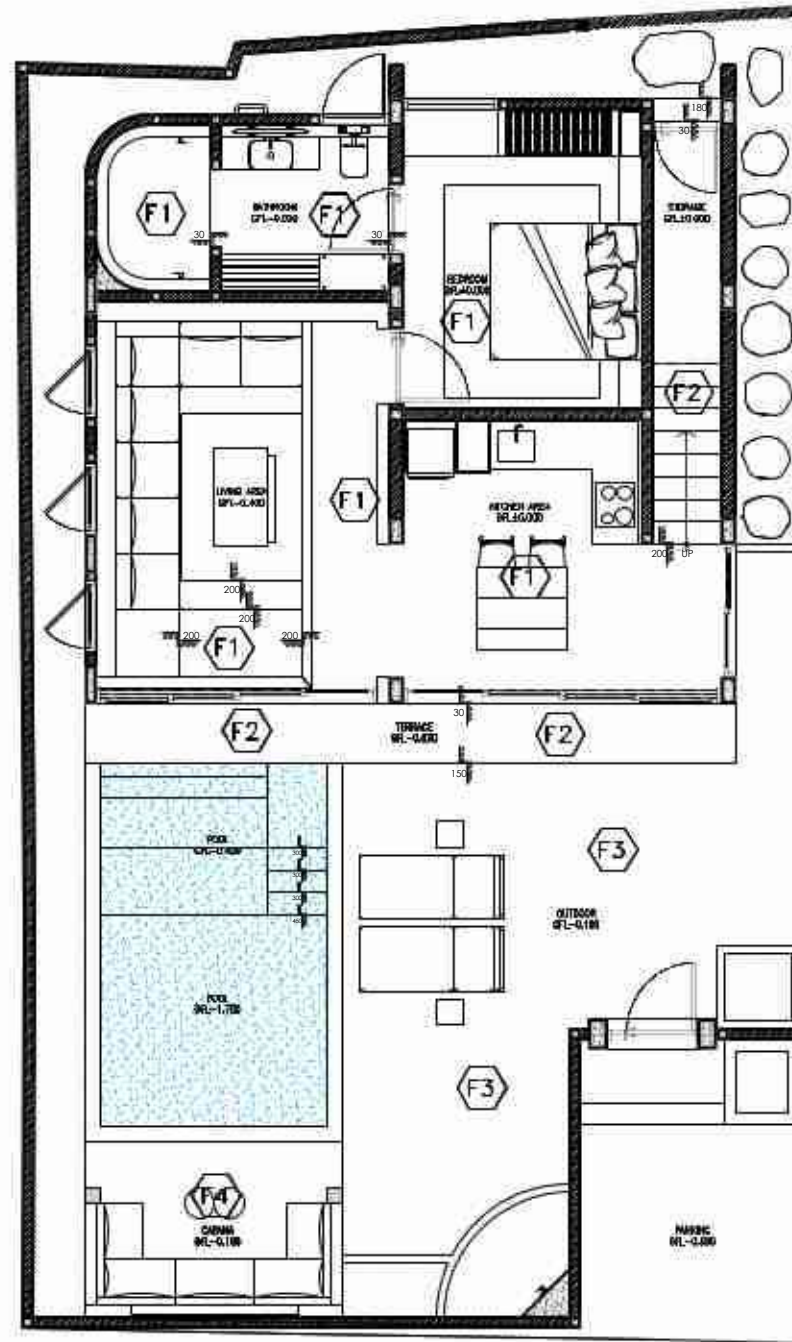

KETERANGAN

F1	VICENTINA STONE TILE
F2	SPECIAL BRICKS
F3	PURIFIED PAVING COBBLESTONE
F4	CONCRETE BASE TEXTURE GREY COLOR
F5	TEAK WOOD FINISH WALKOUT

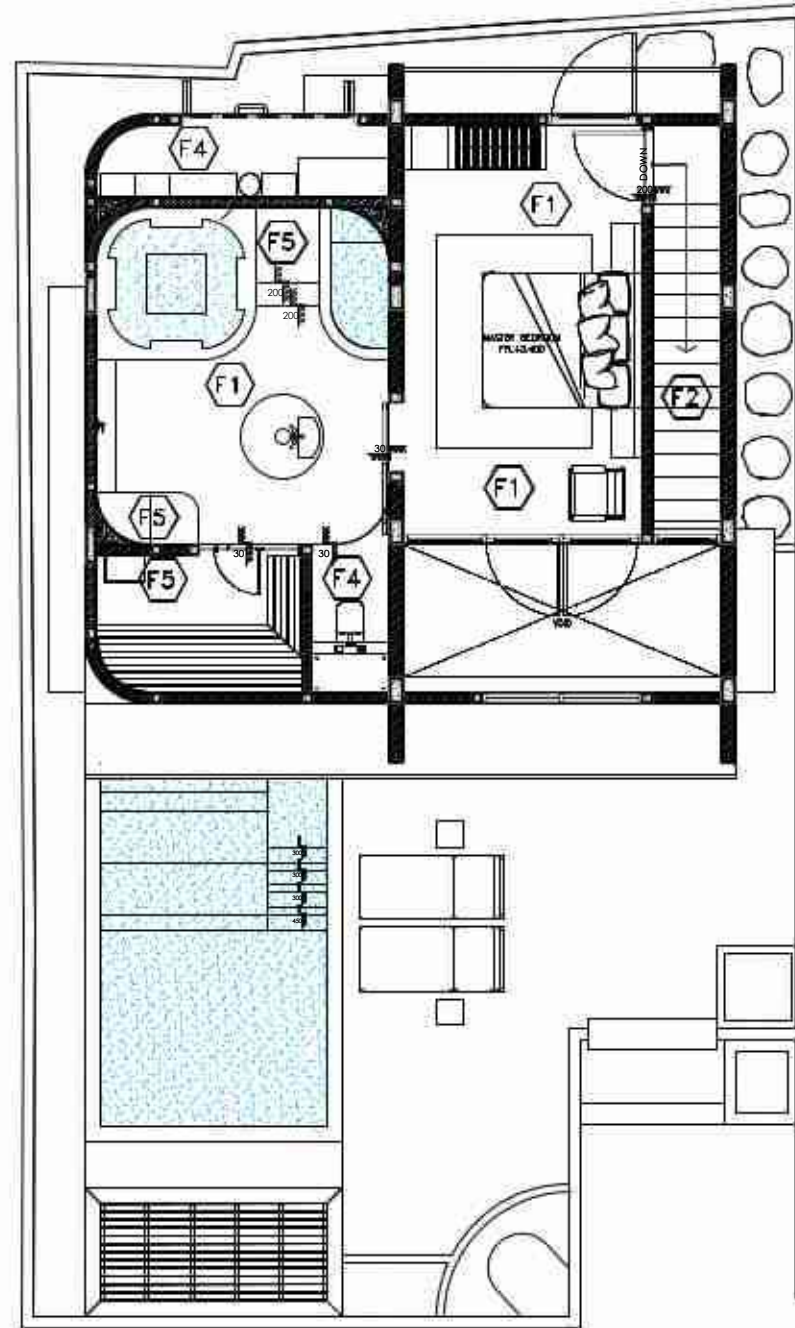

KETERANGAN	
F1	VICENTINA STONE TILE
F2	SPECIAL BRICKS
F3	PURIFIED PAVING COBBLESTONE
F4	CONCRETE BASE TEXTURE GREY COLOR
F5	TEAK WOOD FINISH WALNUT

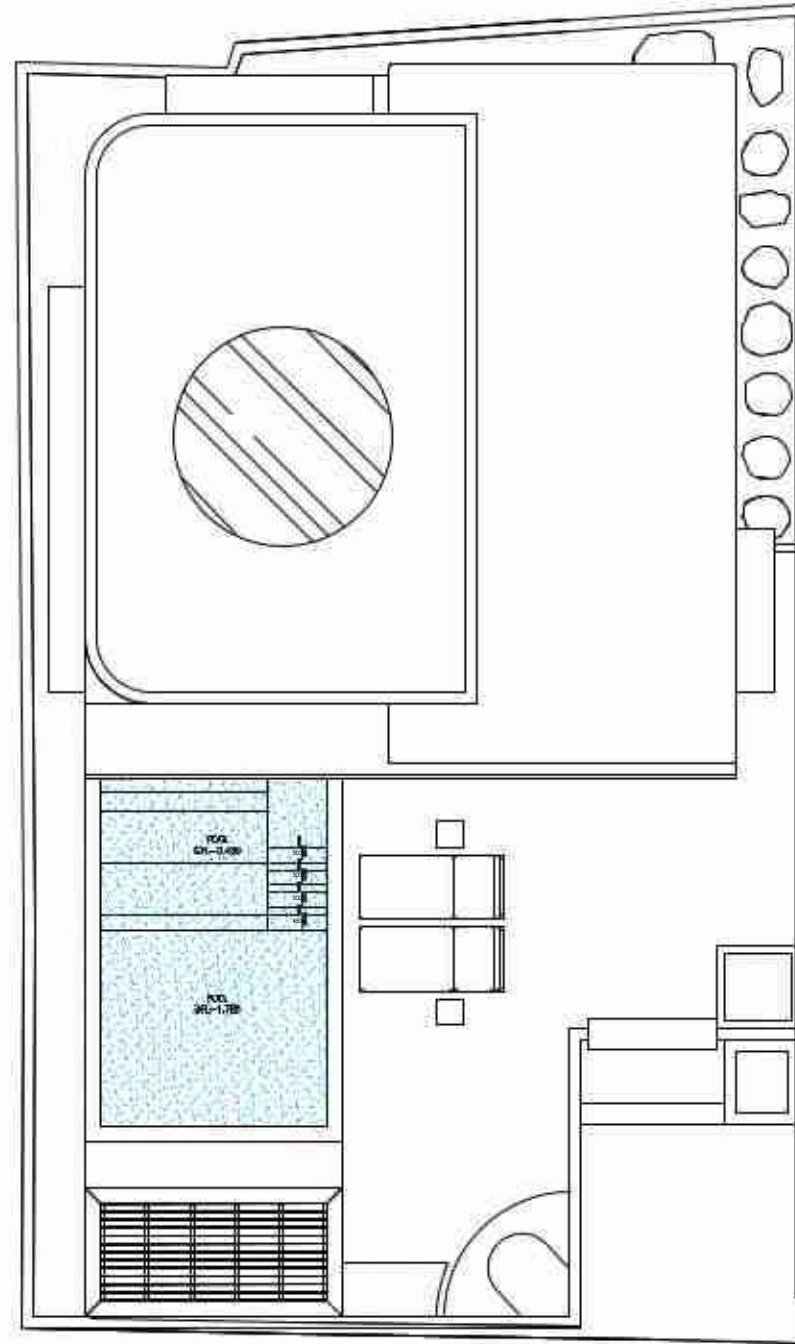

KETERANGAN	
(T1)	VICENTINA STONE TILE
(T2)	SPECIAL BRICKS
(T3)	PURPURA PAVING COBBLESTONE
(T4)	CONCRETE BASE TEXTURE GREY COLOR
(T5)	TEPAK BERSI FIN DRAIN PALUJIT

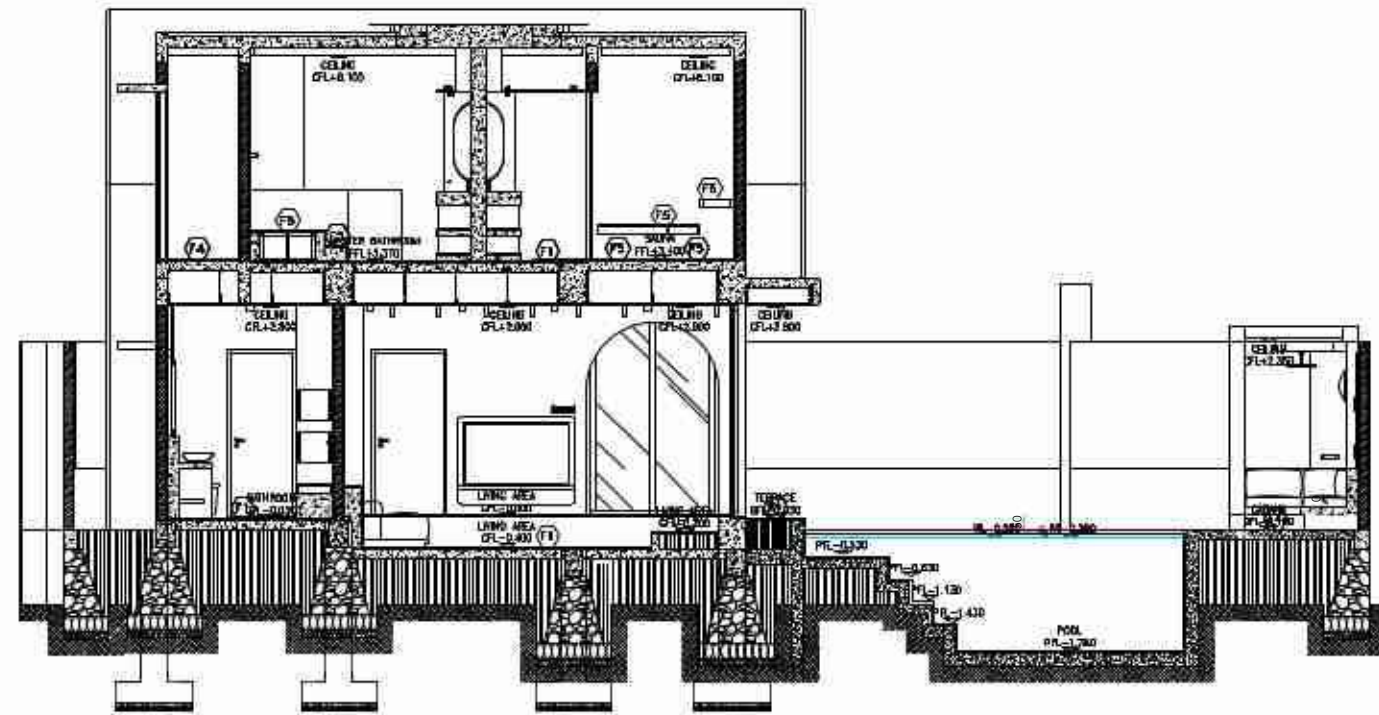
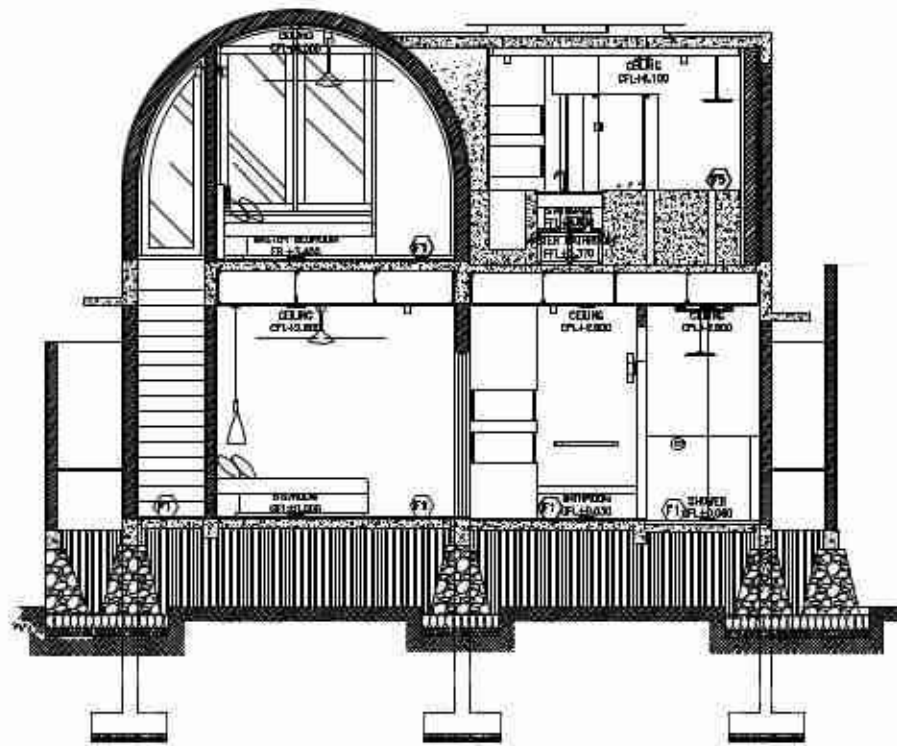
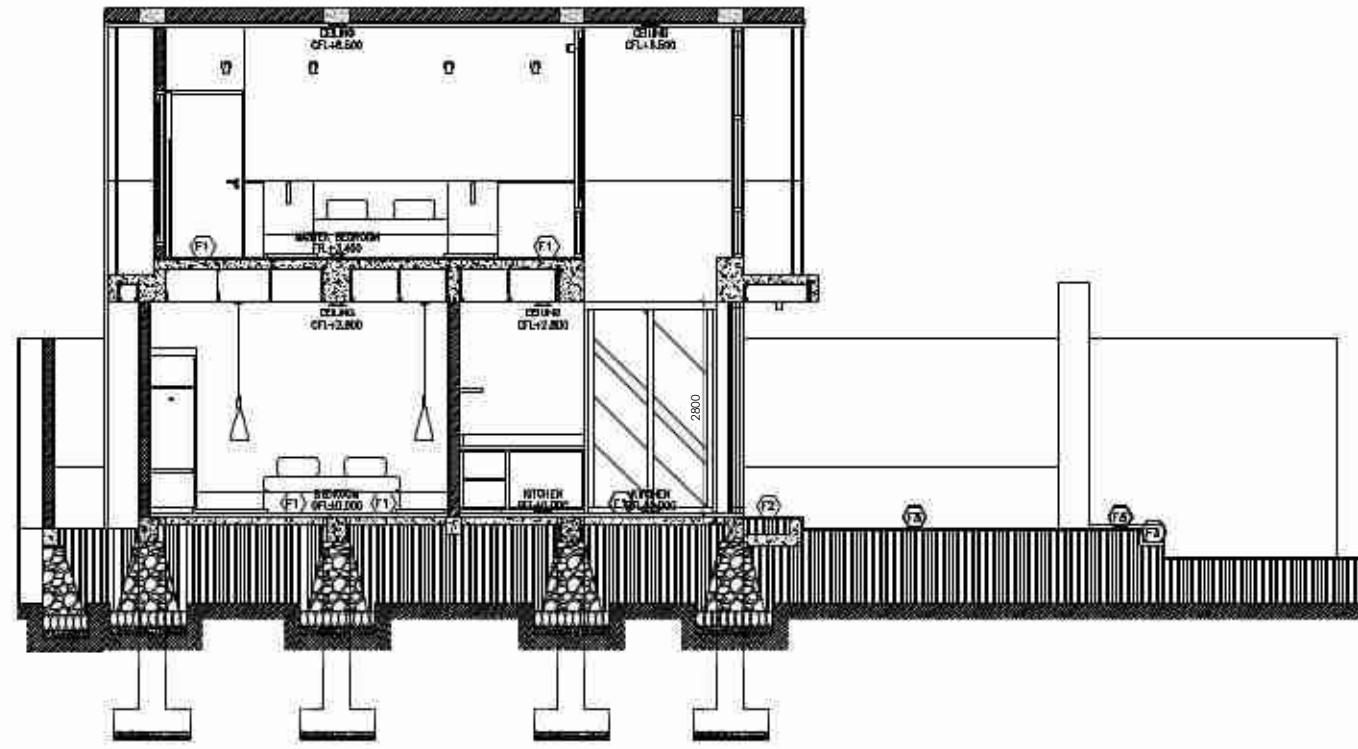
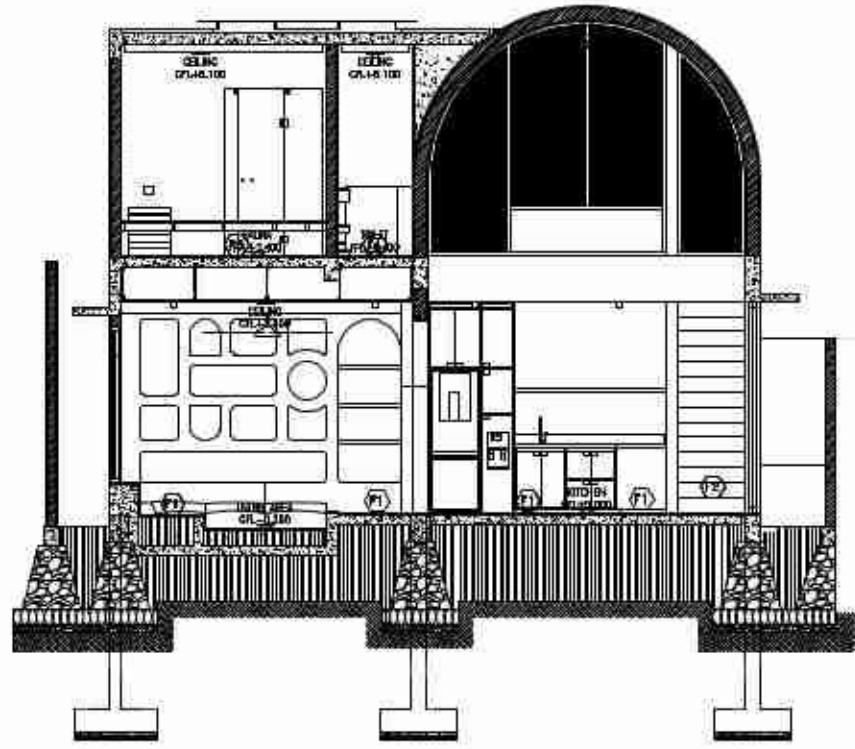

KETERANGAN	
(F1)	VICENTINA STONE TILE
(F2)	SPECIAL BRICKS
(F3)	PERFIDO PAVING COBBLESTONE
(F4)	CONCRETE BARE TEXTURE GREY COLOR
(F5)	TEAK WOOD FINISH WALKWAY

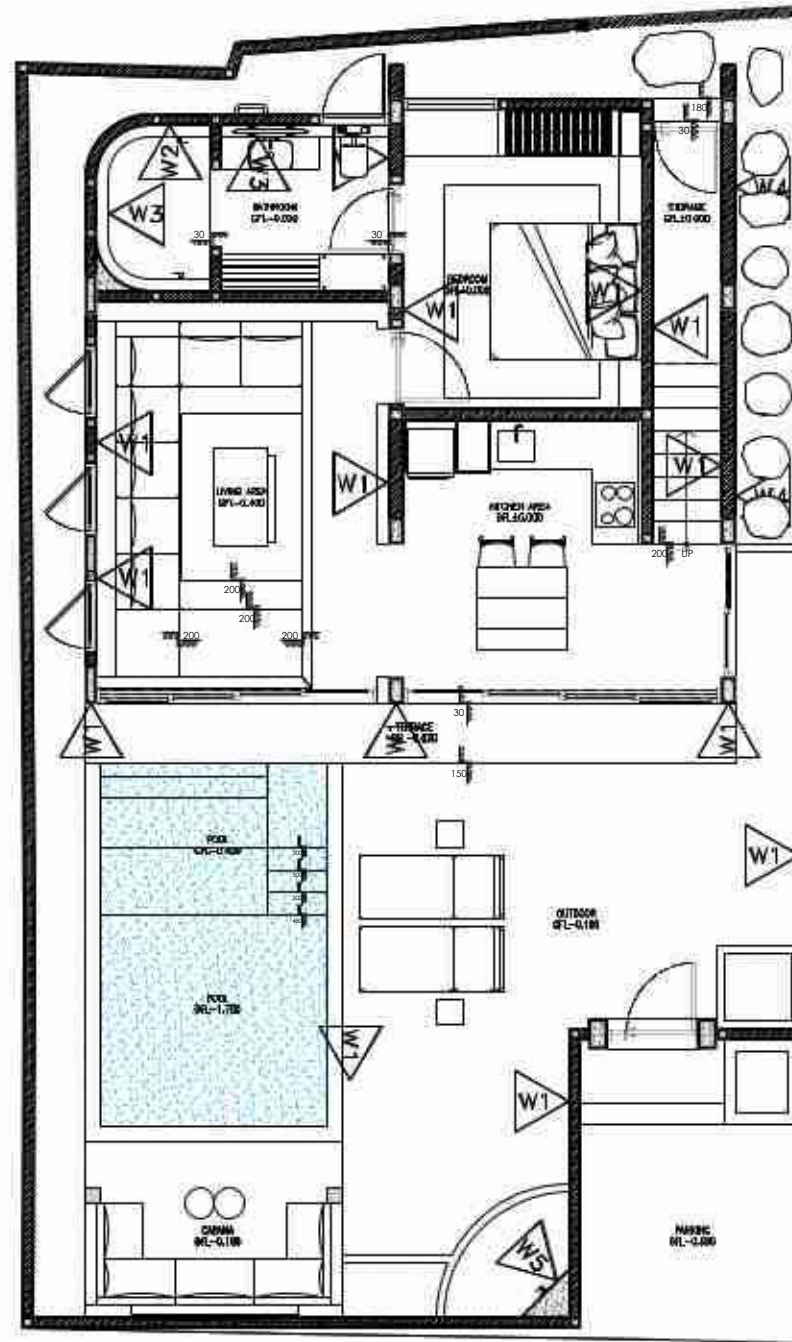

KETERANGAN	
W1	CONCRETE BARE TEXTURE HAZELHIT PANTONE COLOR
W2	HORIZONTAL MARBLE TILE
W3	CONCRETE BARE TEXTURE GREY COLOR
W4	CONCRETE BARE TEXTURE PREFER TO BRACE
W5	CONCRETE BARE TEXTURE PREFER TO BRACE
W6	TEAK WOOD FIN OFFER VULKUIT
W7	SPECIAL BRICKS

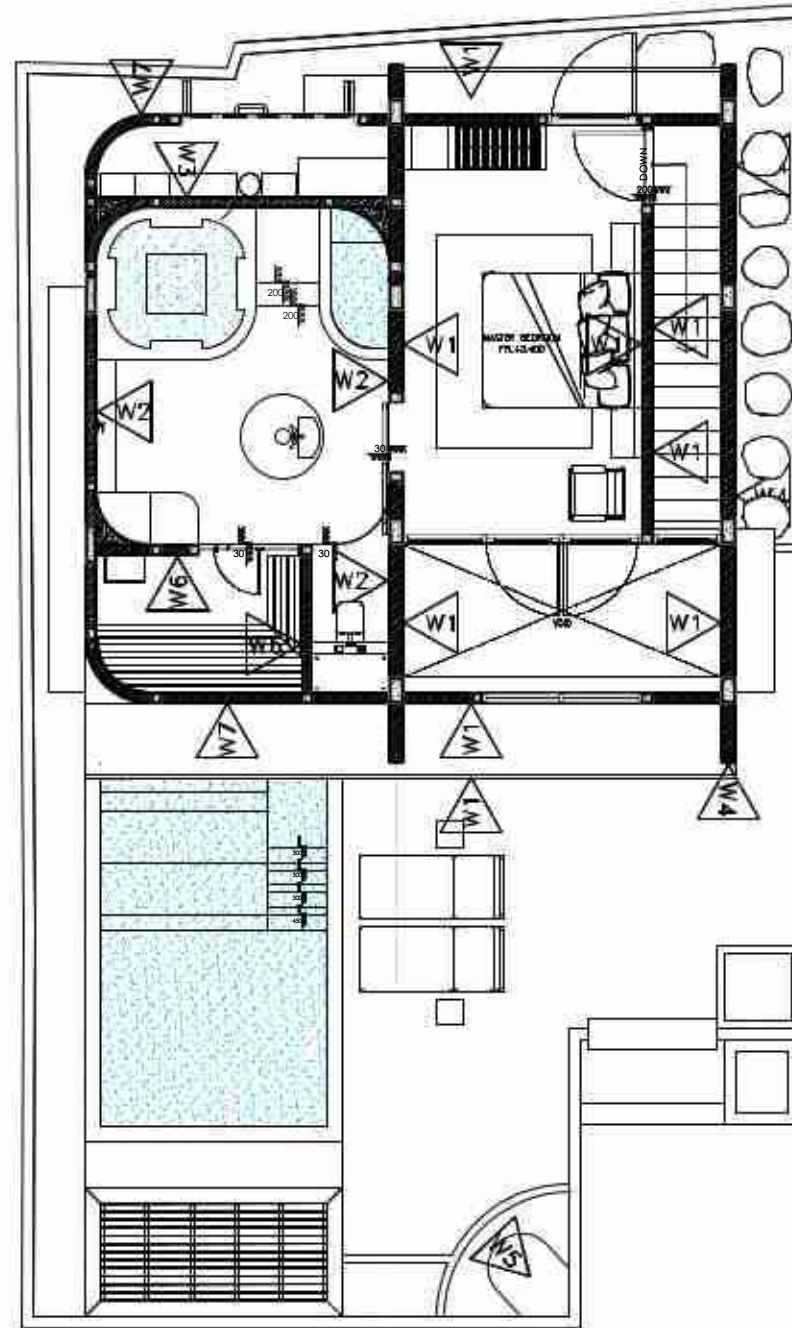

KETERANGAN	
W1	CONCRETE BARE TEXTURE HAZELHUT PANTONE COLOR
W2	HORIZONTAL MARBEL TILE
W3	CONCRETE BARE TEXTURE GREY COLOR
W4	CONCRETE BARE TEXTURE PREFER TO INAGE
W5	CONCRETE BARE TEXTURE PREFER TO INAGE
W6	TEAK WOOD FIN OFFER VILAHUT
W7	SPECIAL BRICKS

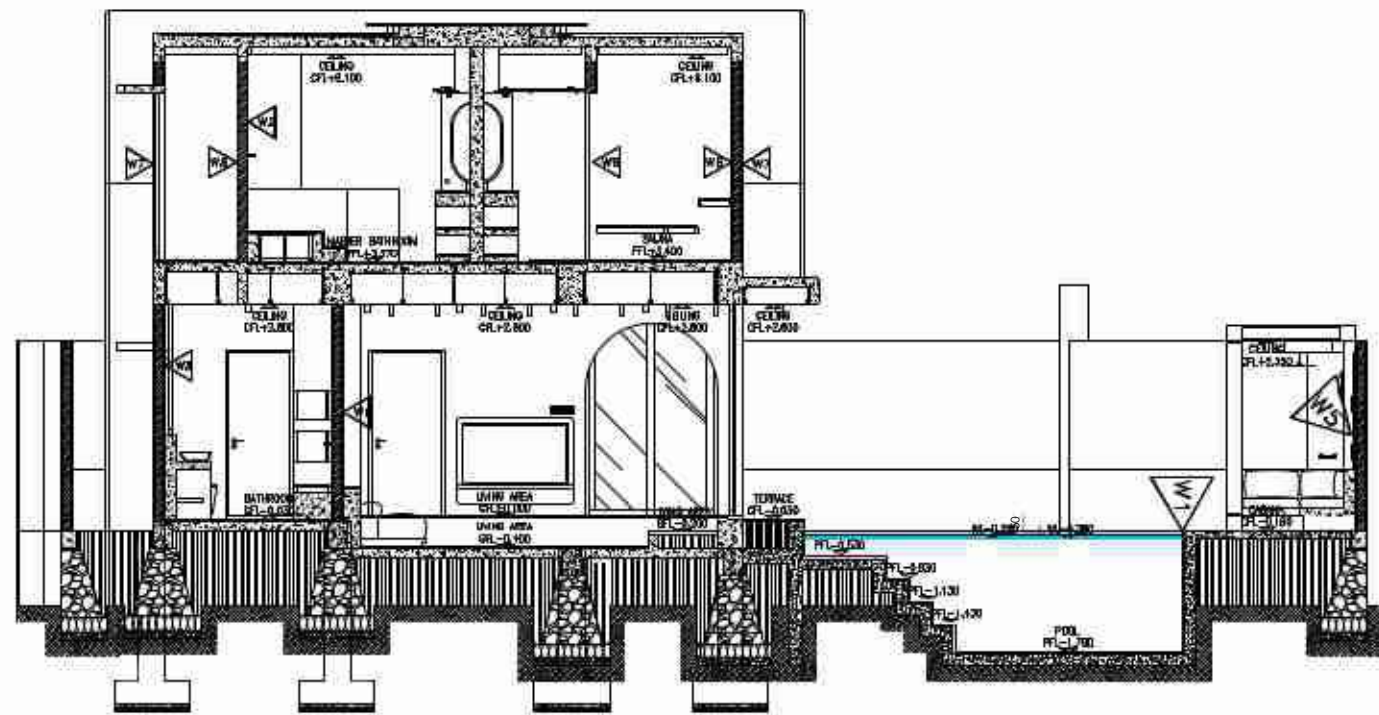
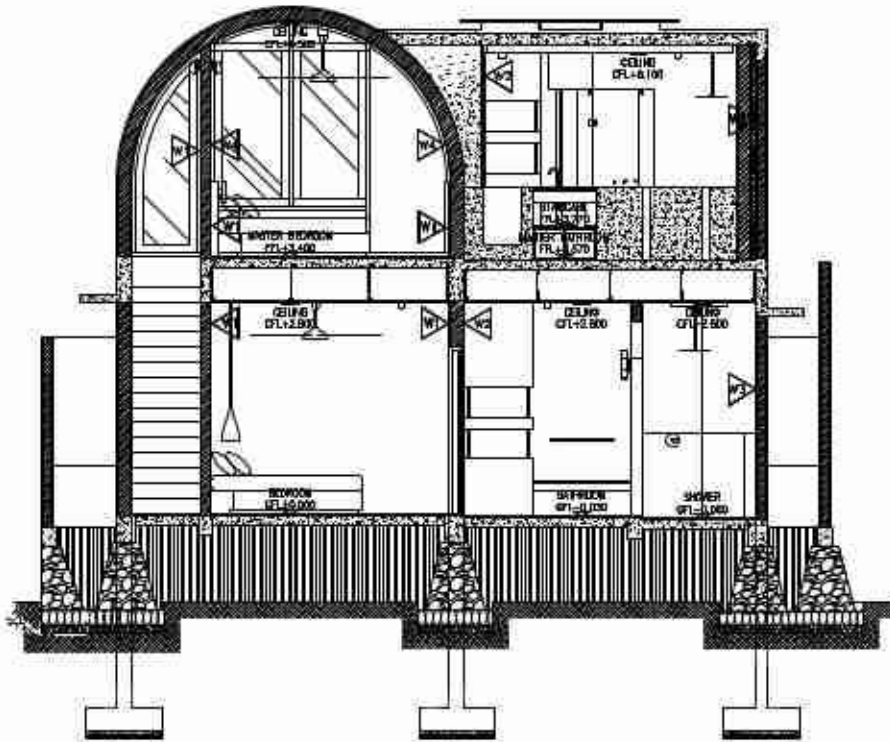
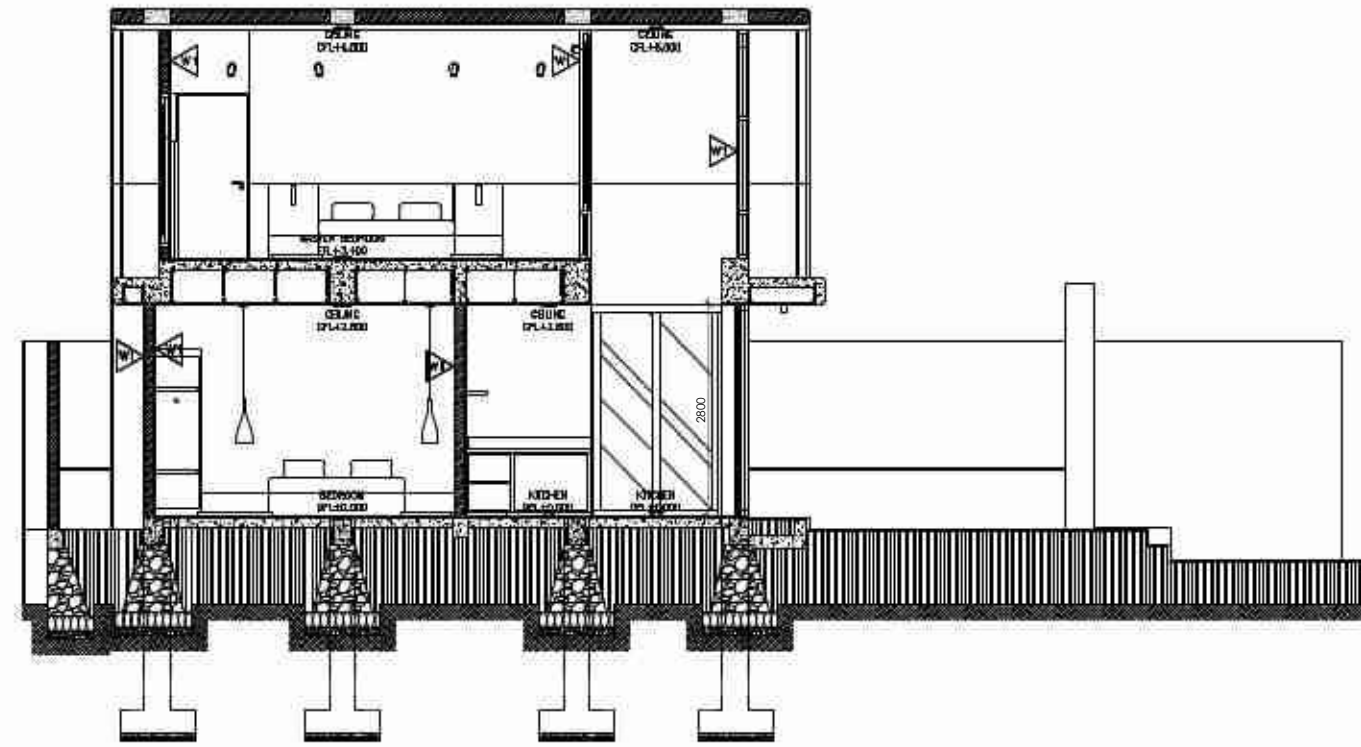
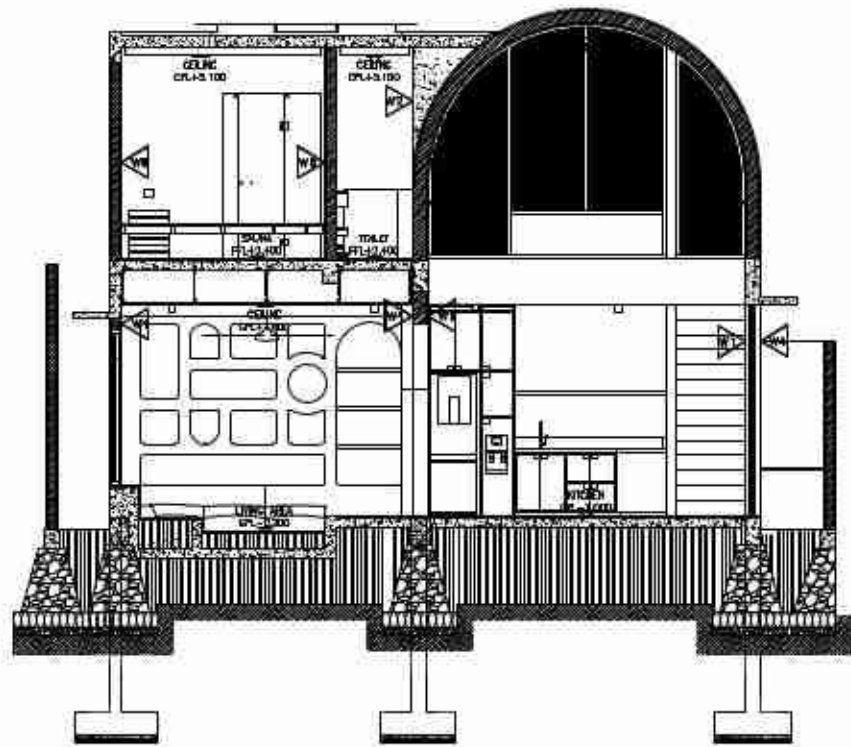

KETERANGAN	
	CONCRETE BASE TEXTURE HAZELNUT PARTONE COLOR
	MOSAIK MARBEL TILC
	CONCRETE BASE TEXTURE GREY COLOR
	CONCRETE BASE TEXTURE PREFER TO IMAGE
	CONCRETE BASE TEXTURE PREFER TO IMAGE
	TEAK WOOD PIN DARK NUHANT
	SPECIAL BRICKS

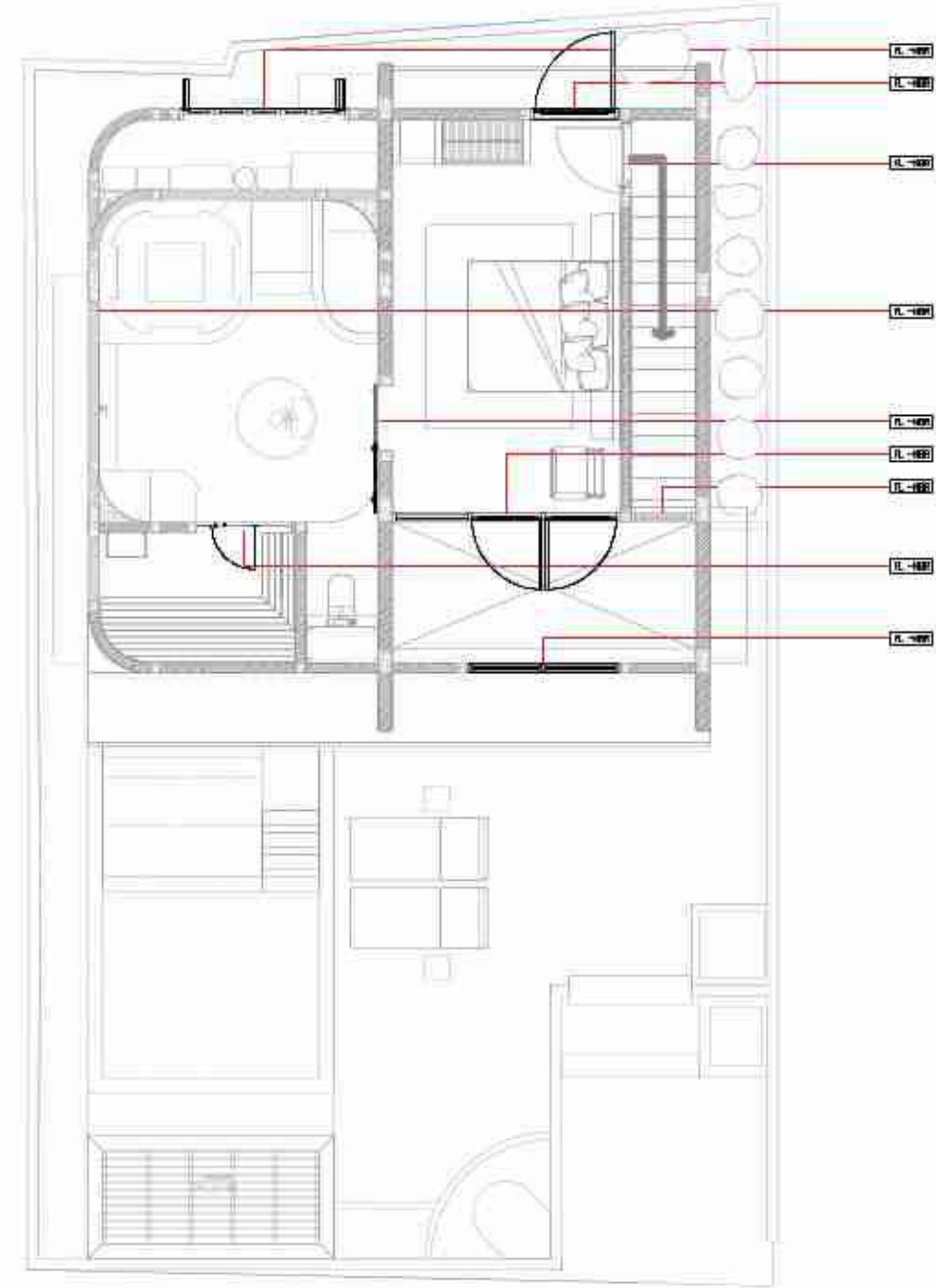
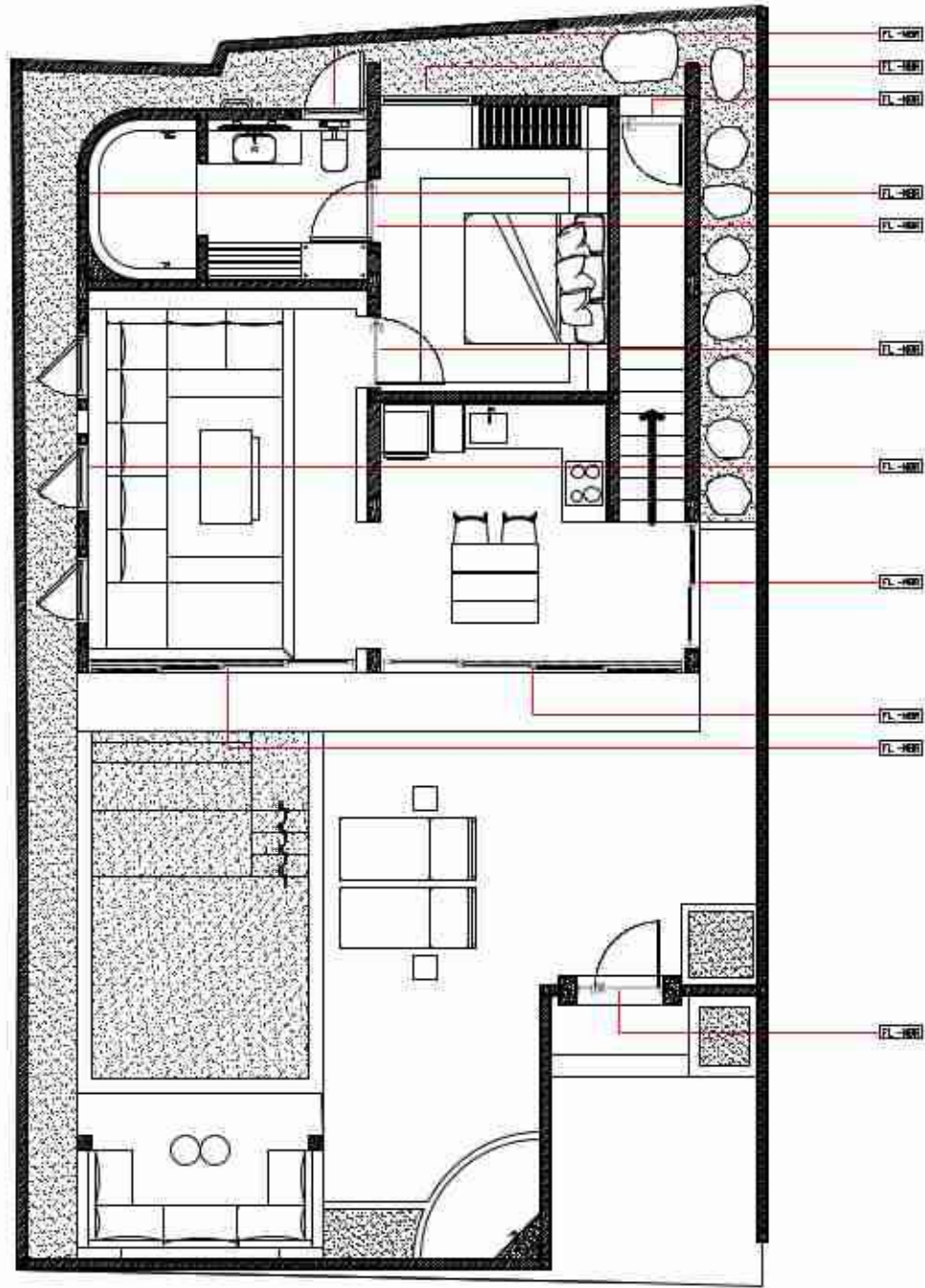

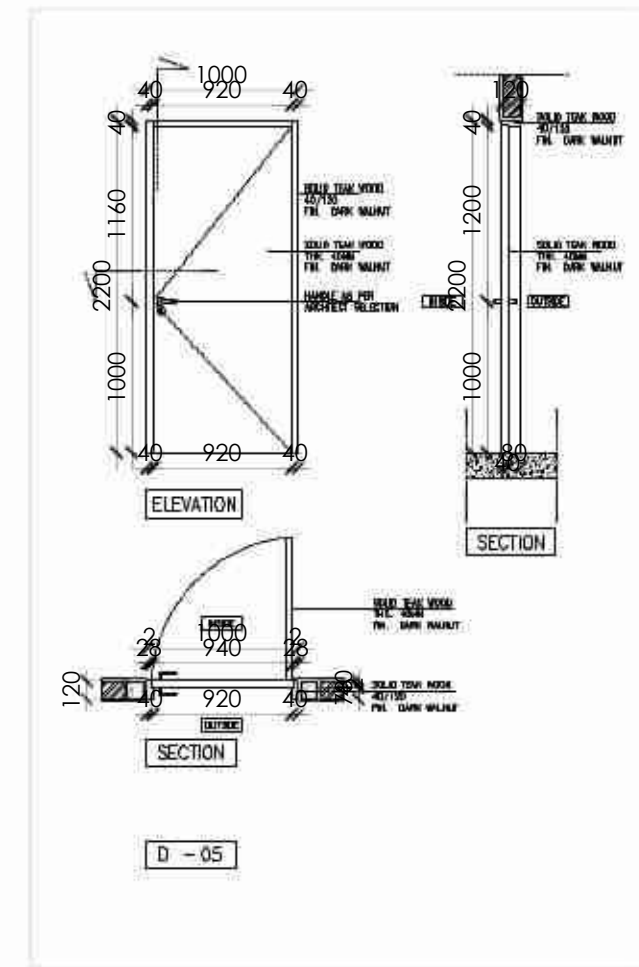
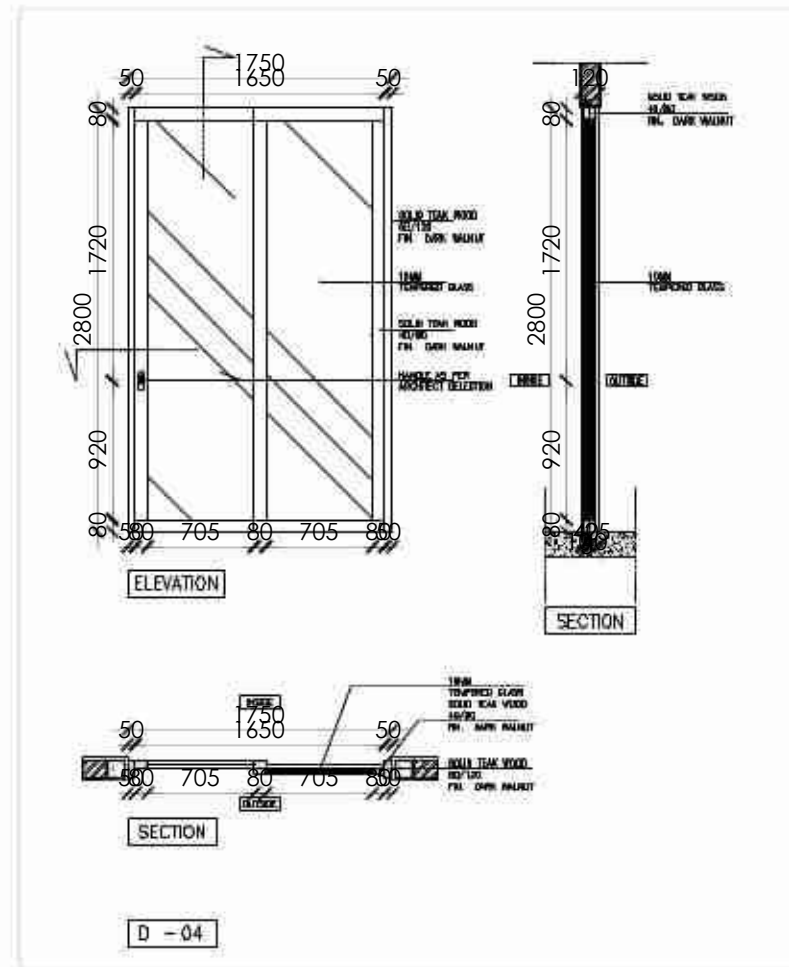
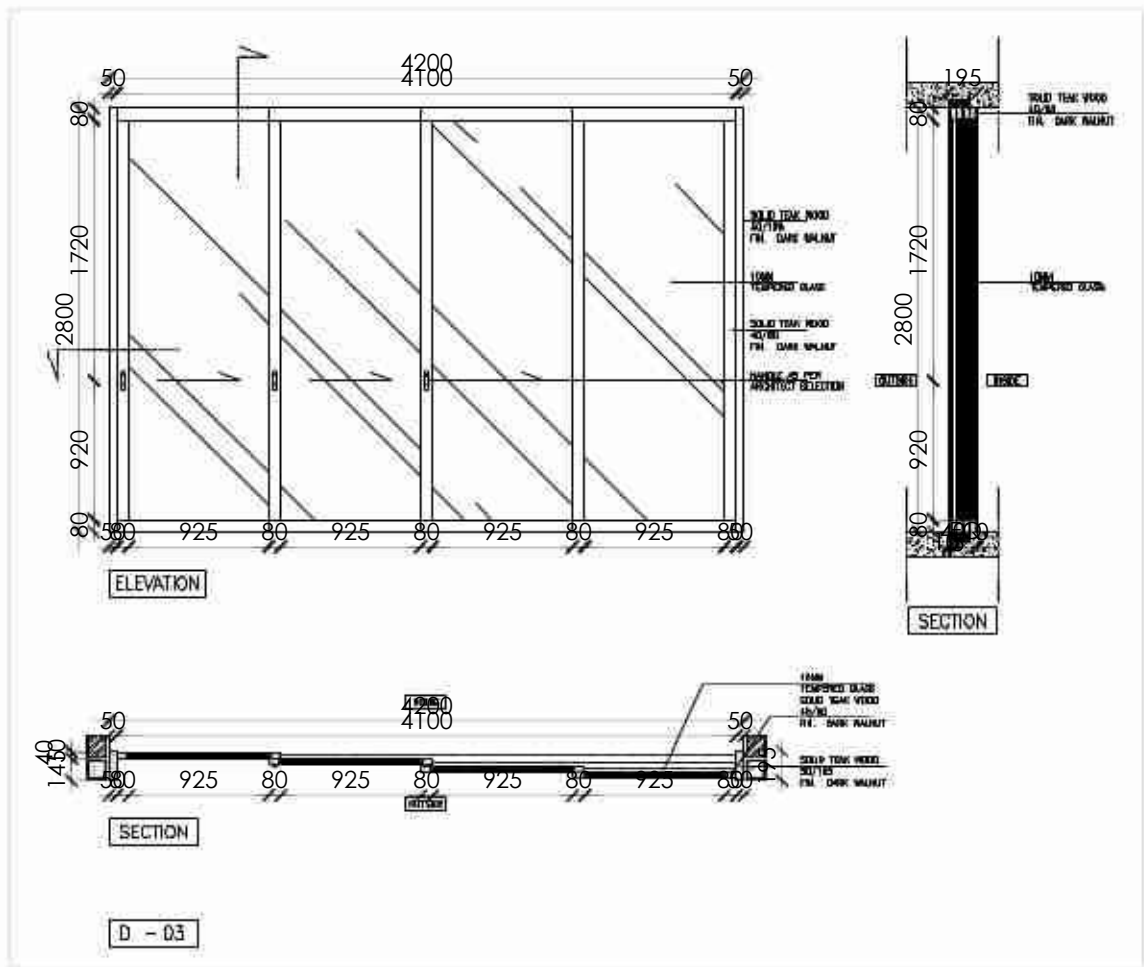
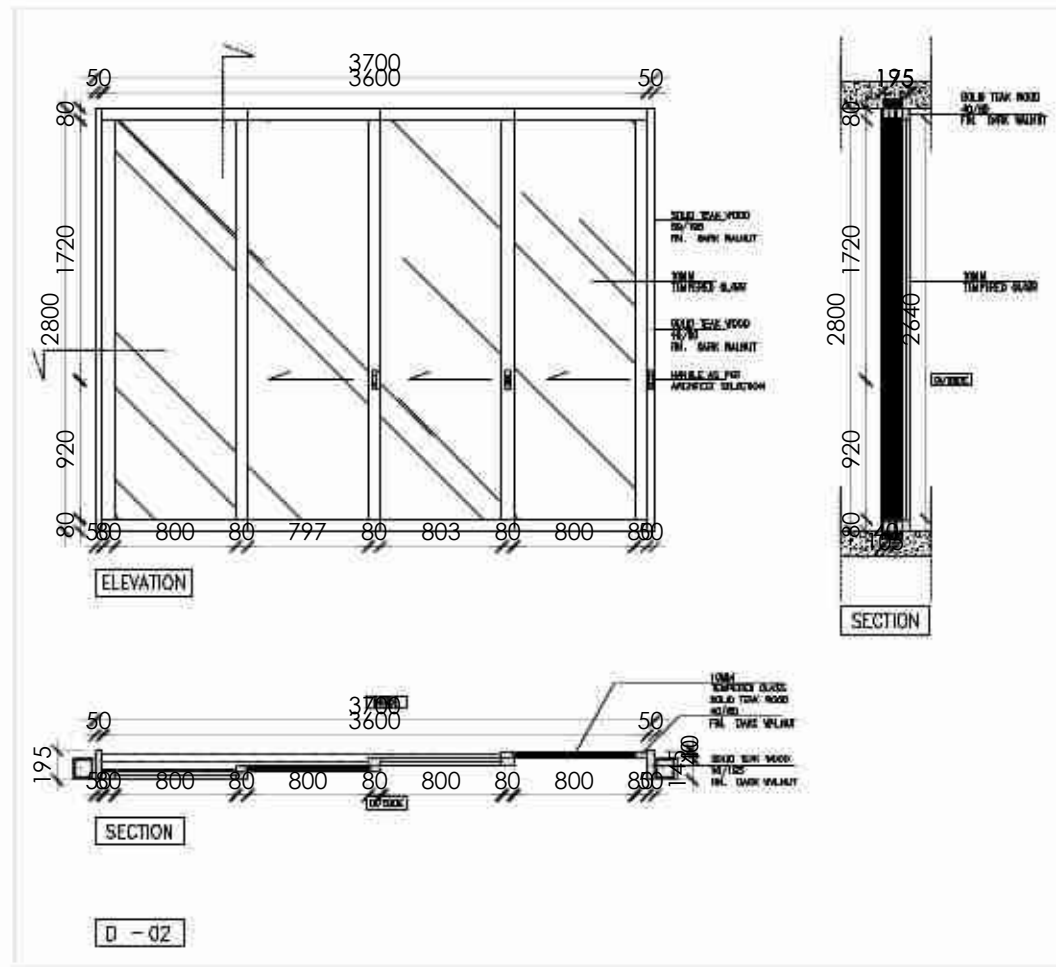
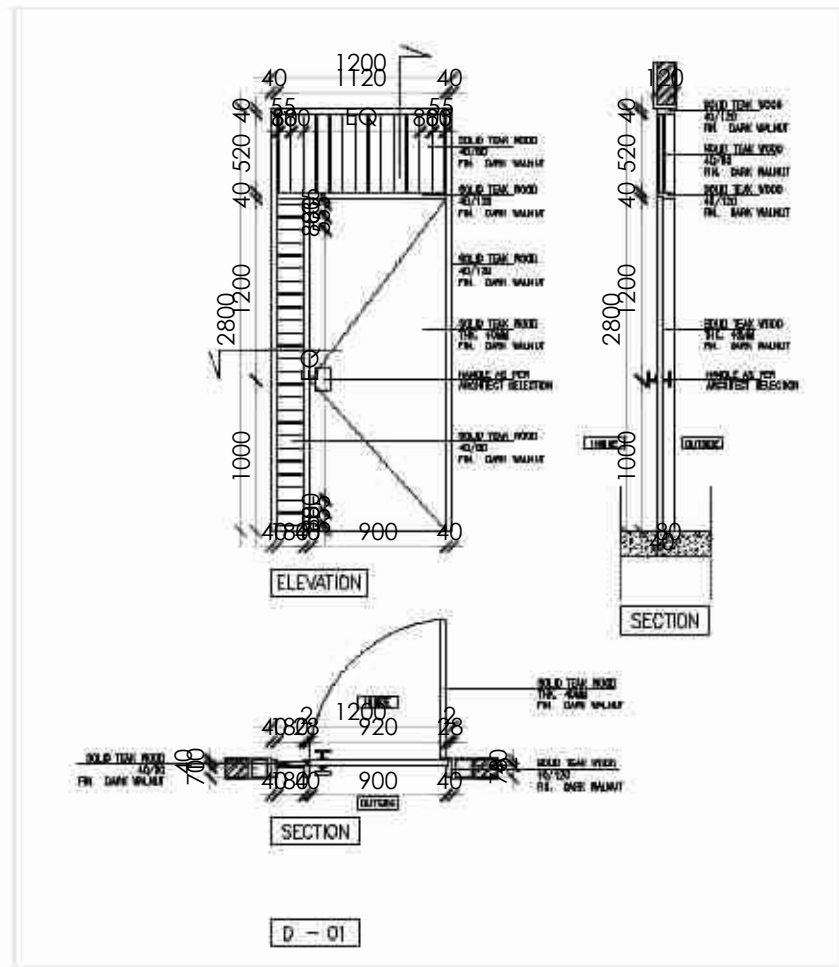

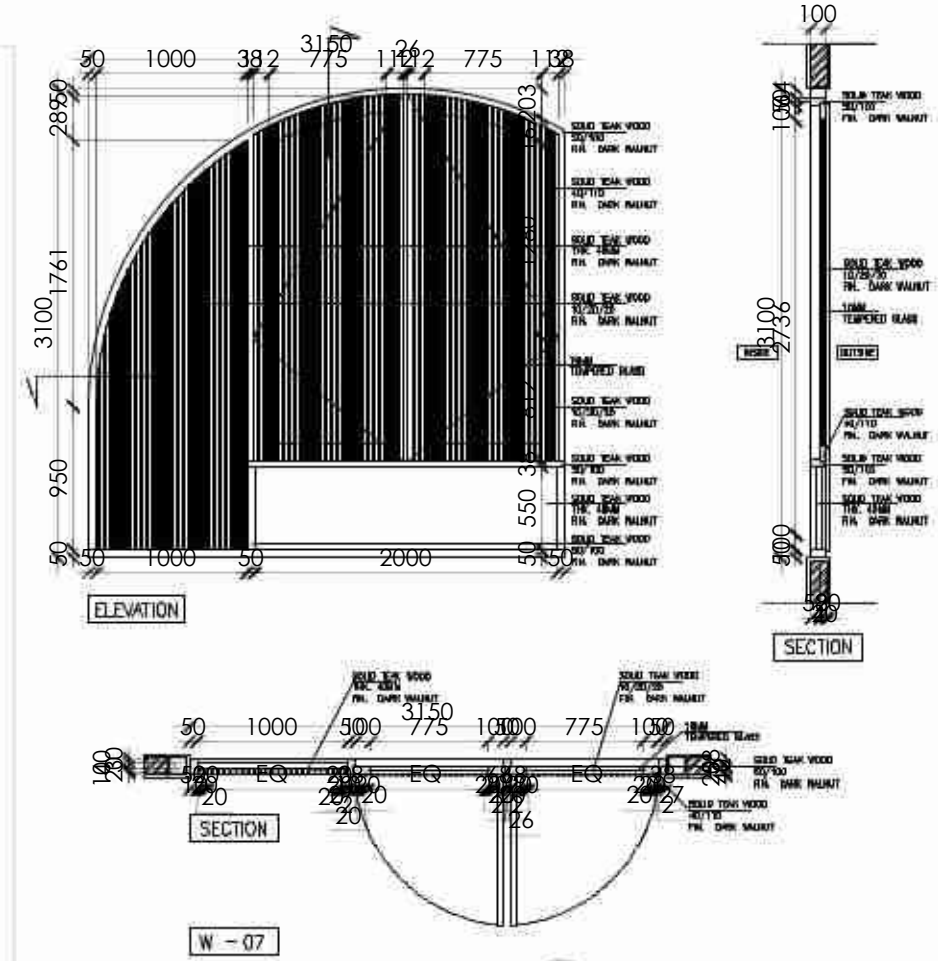
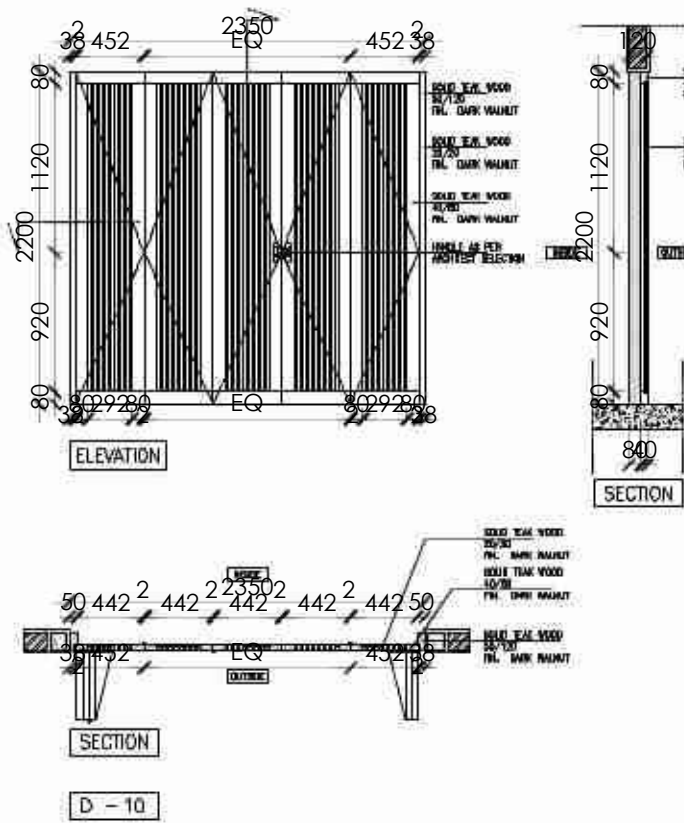
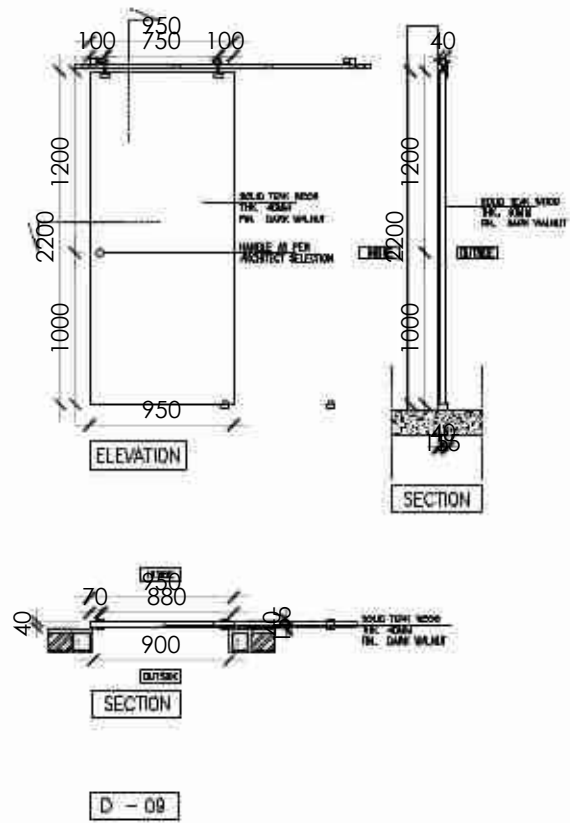
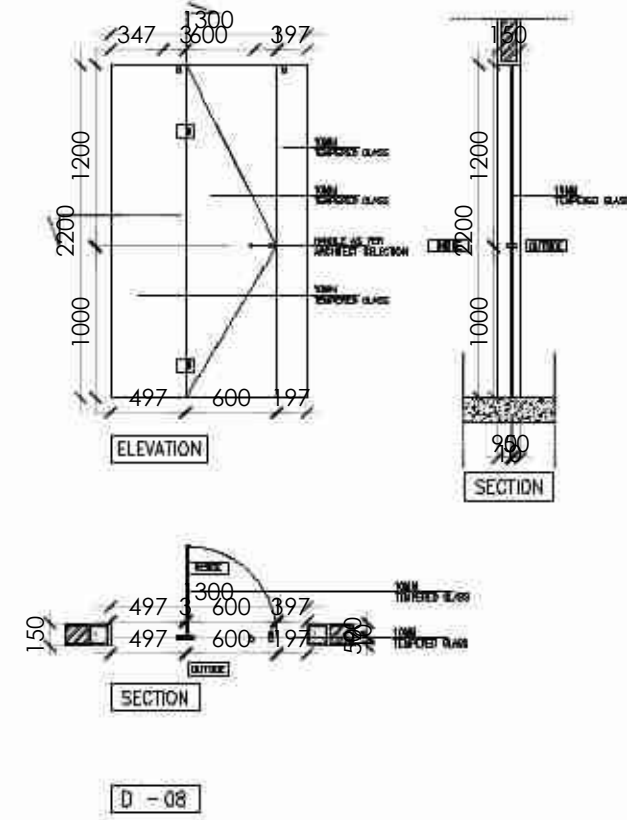
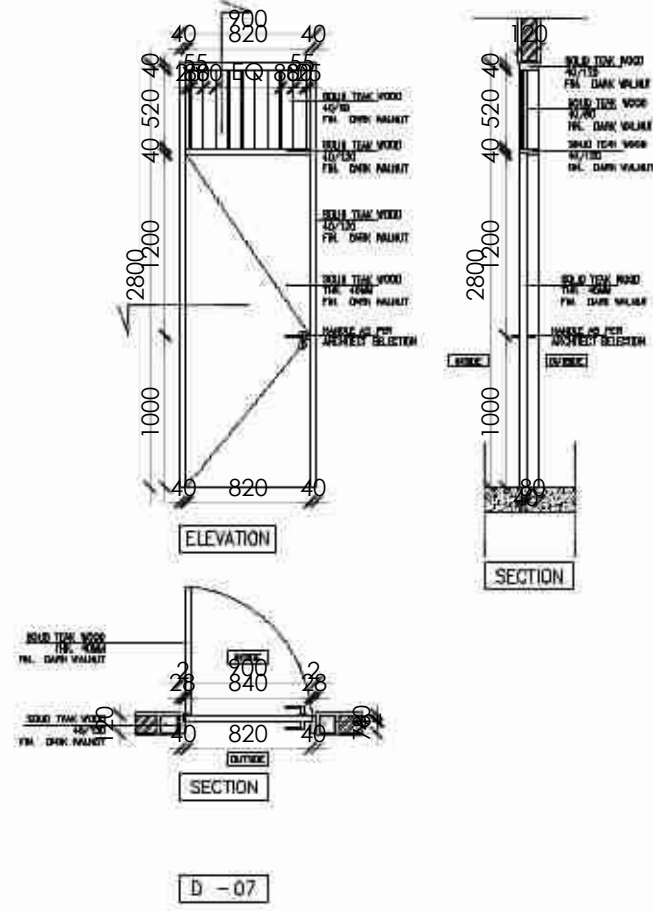
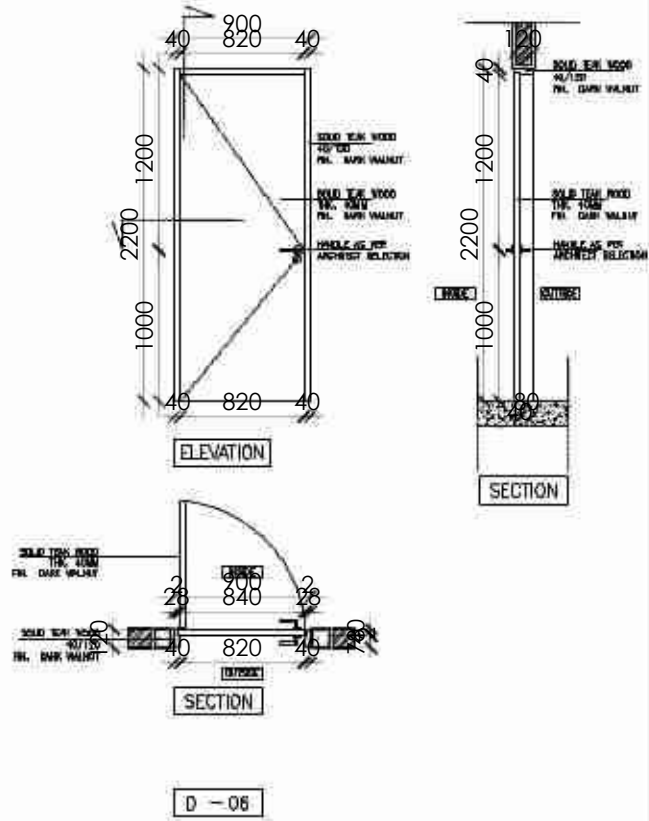

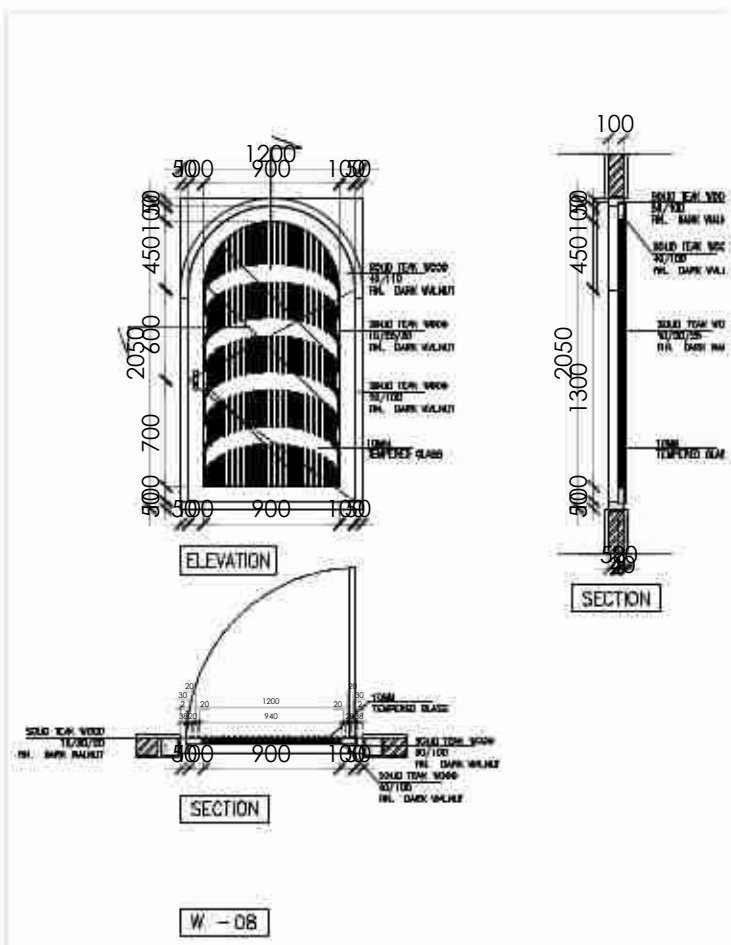
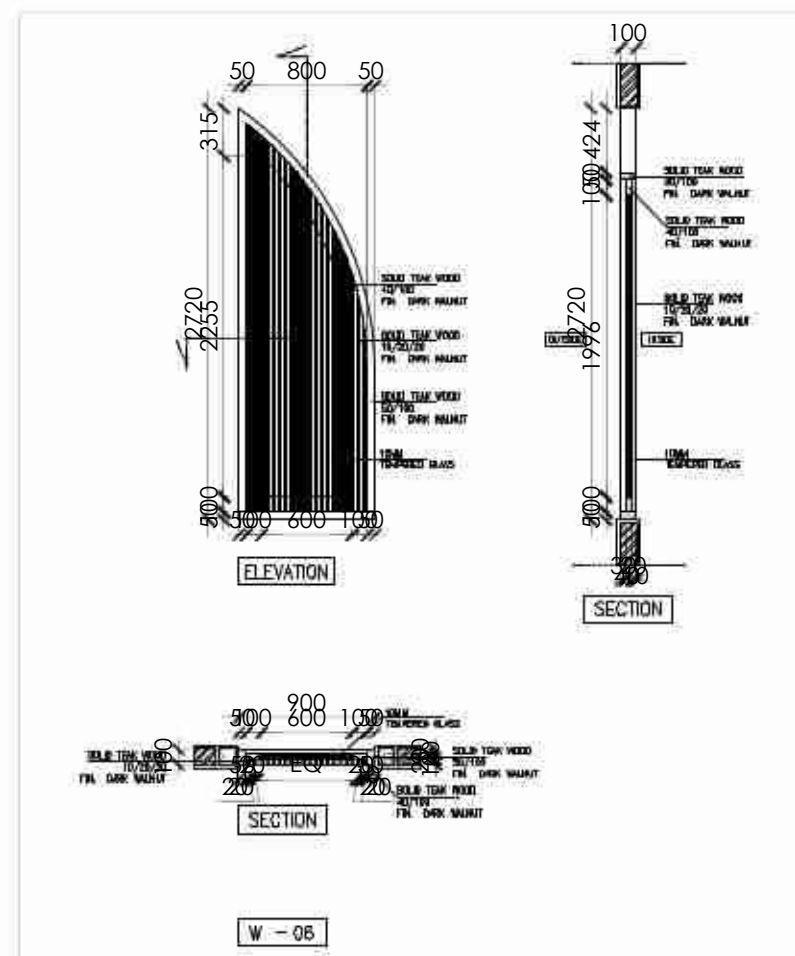
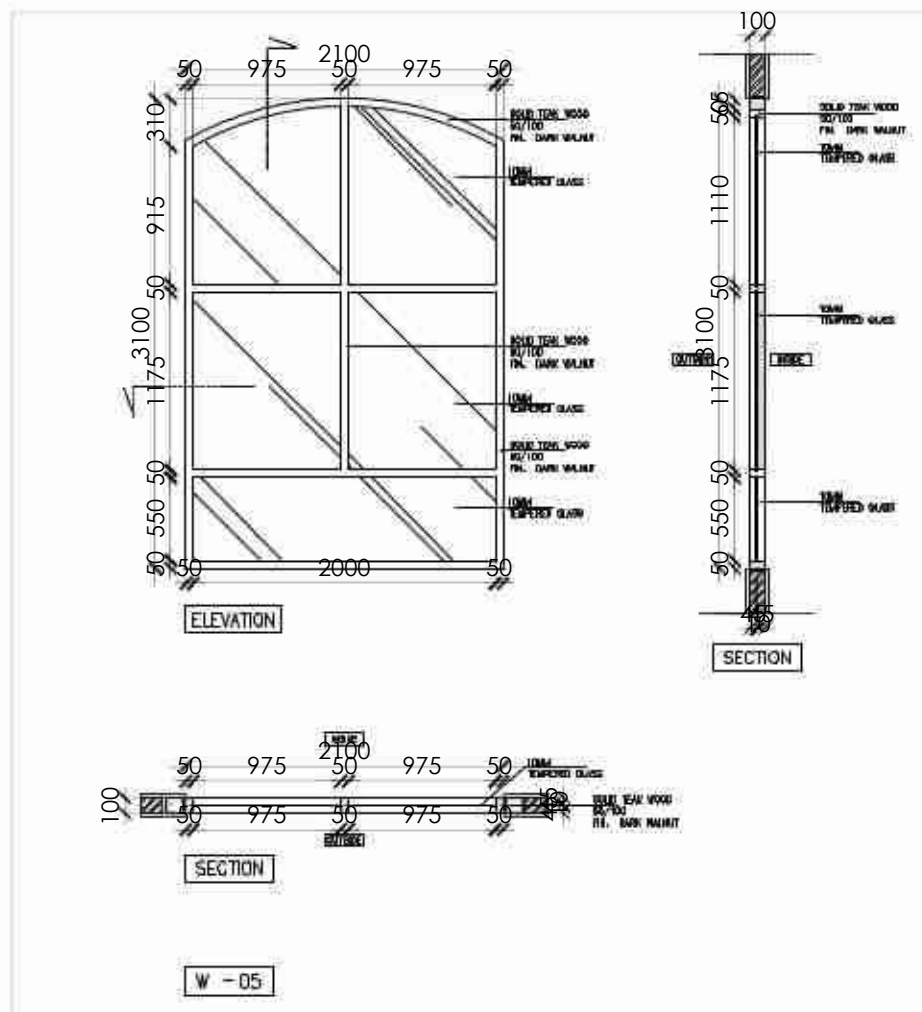
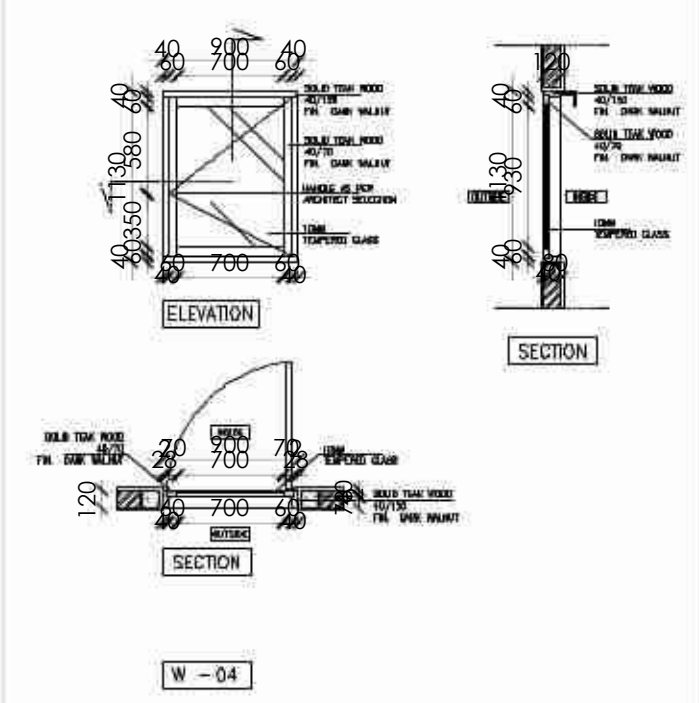
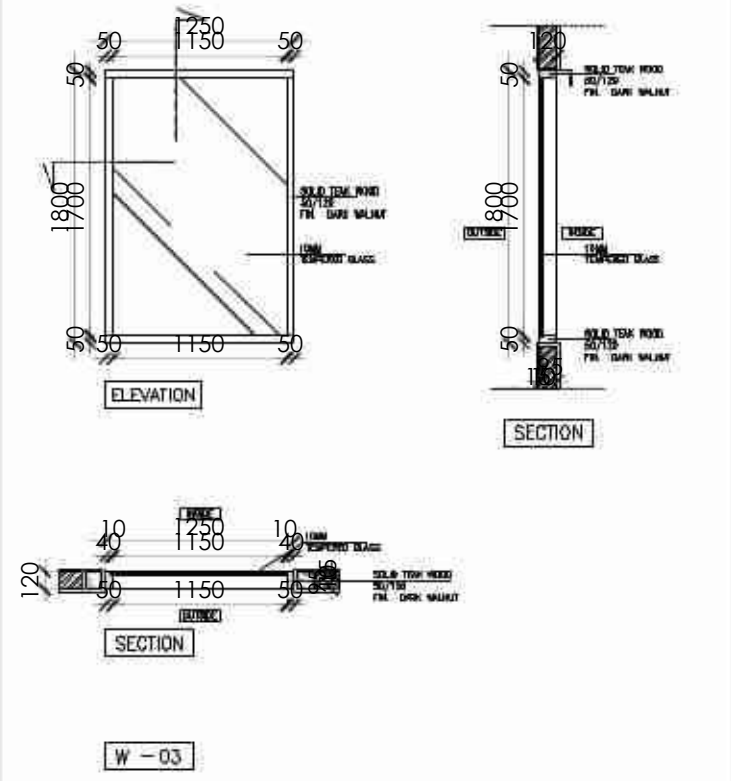
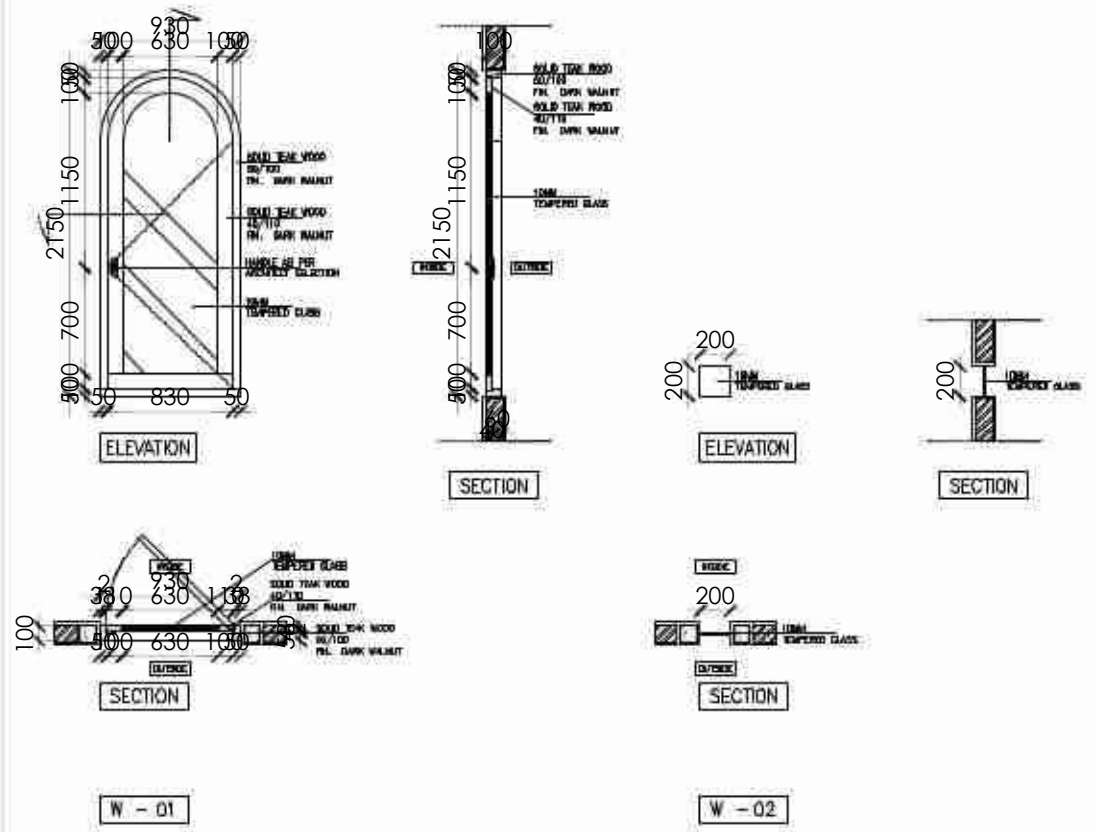

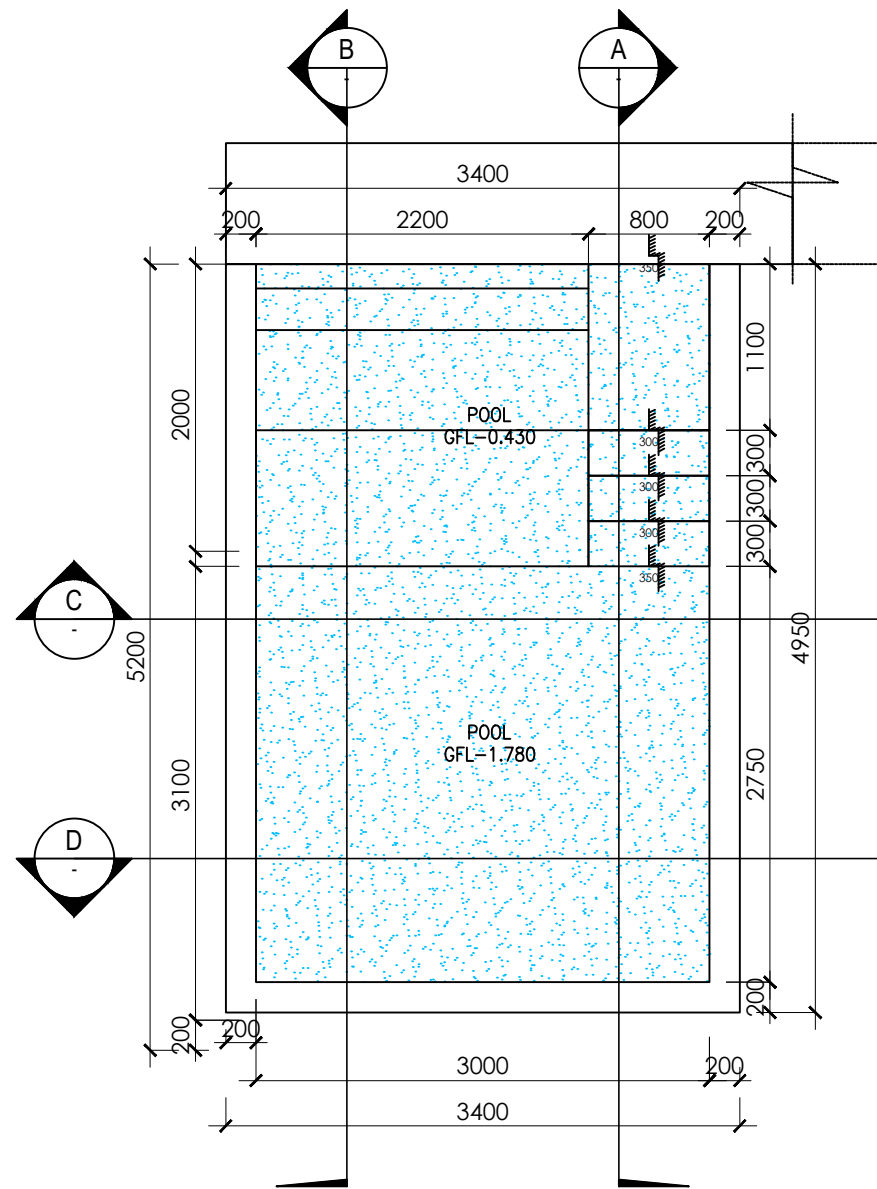

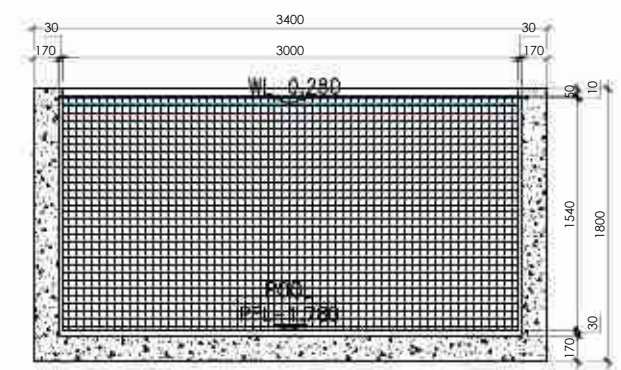
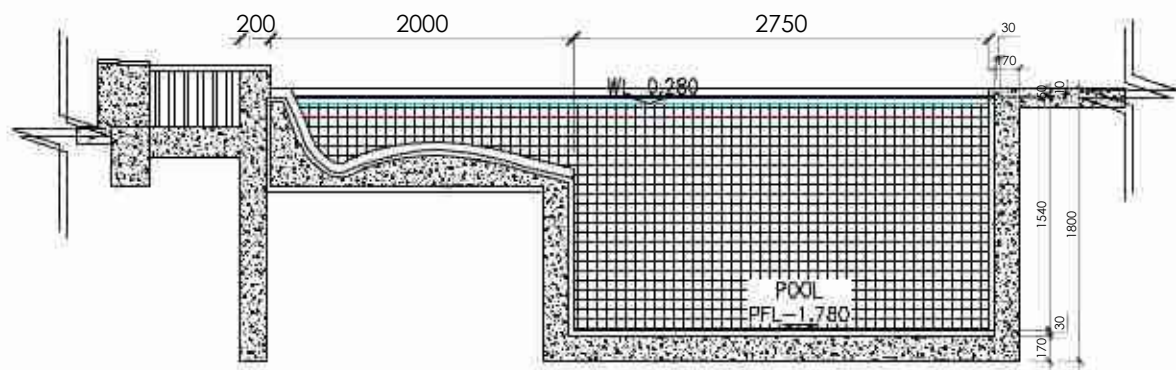
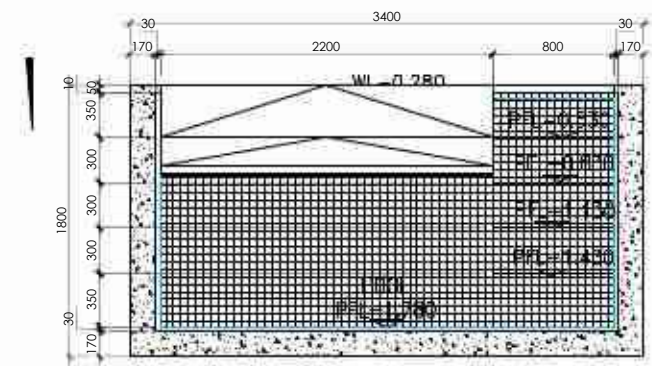
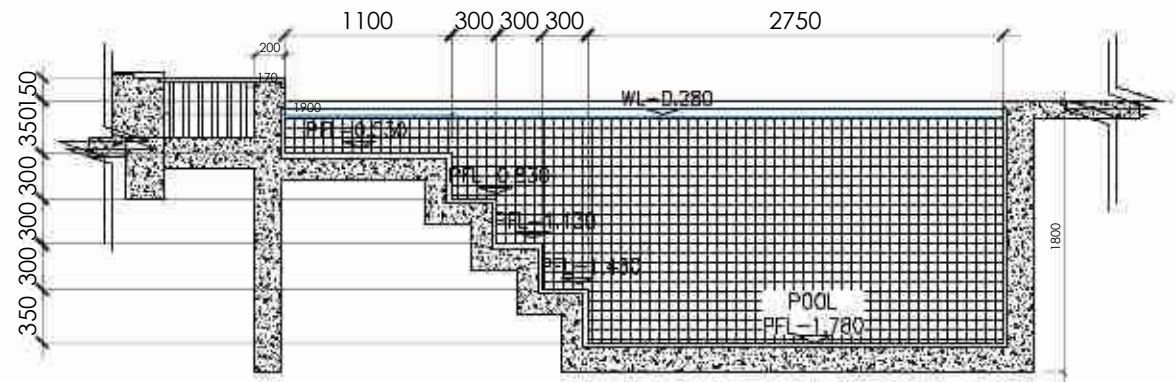

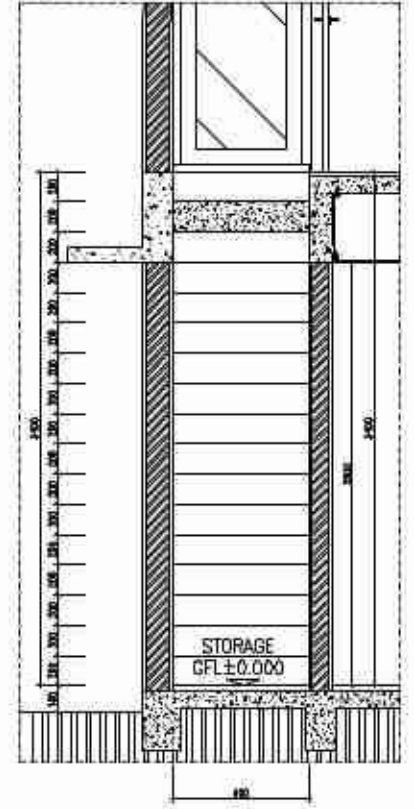
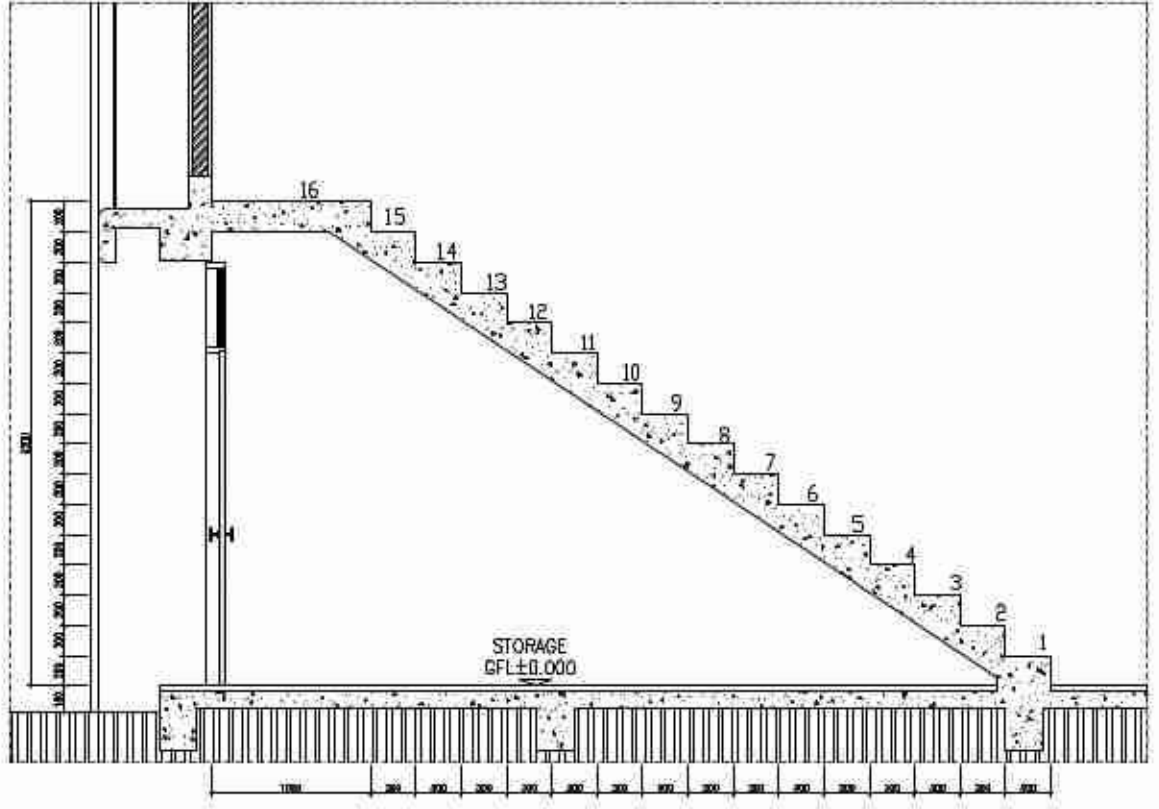
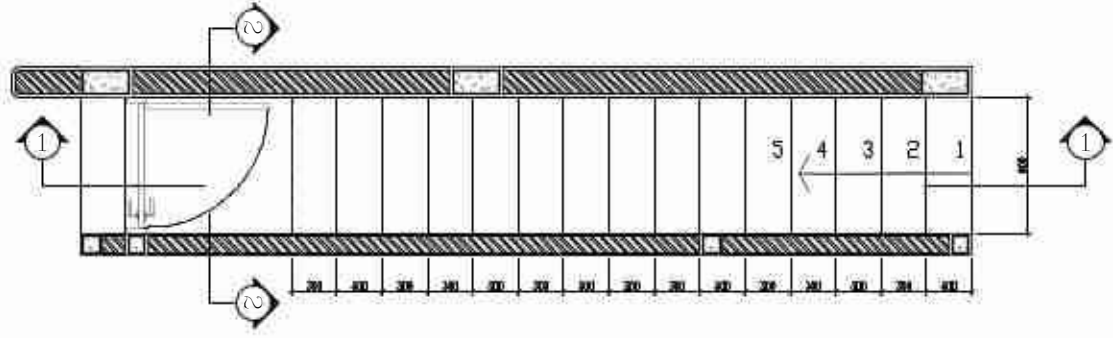
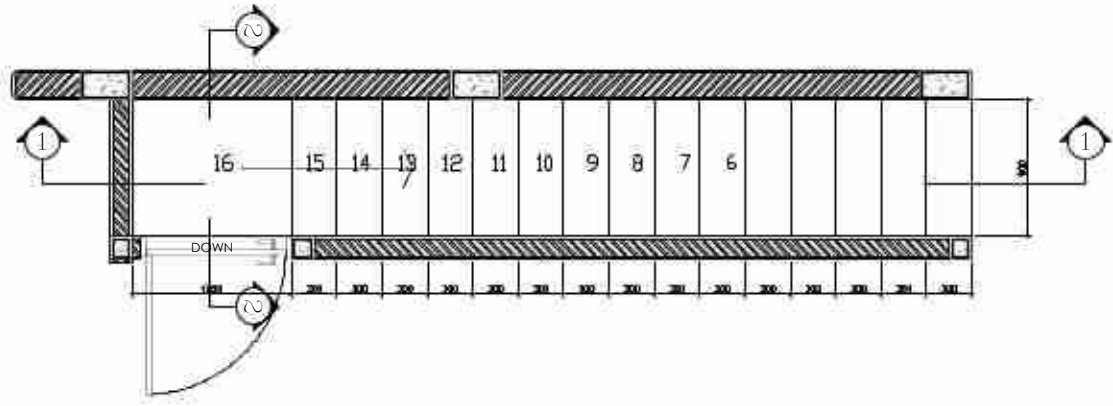

STAIR PLAN, SECTION AND DETAIL VILLA C
Scale 1 : 50

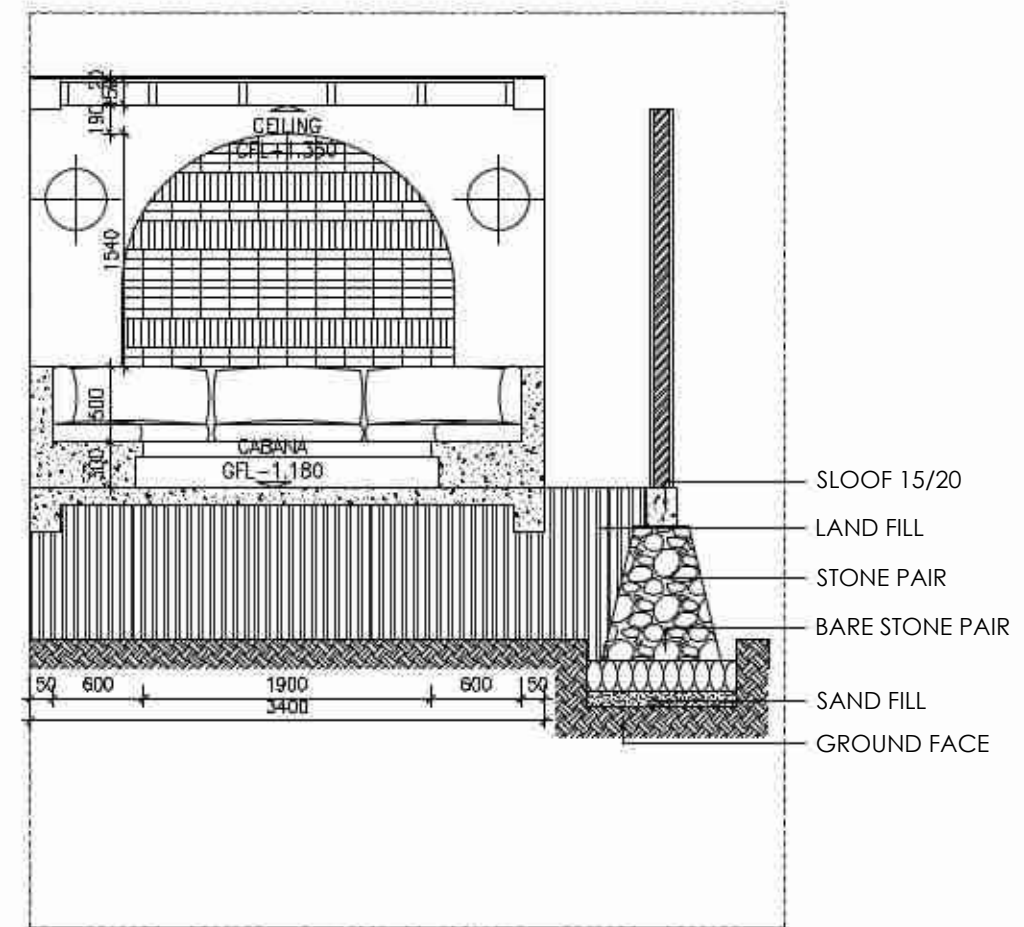
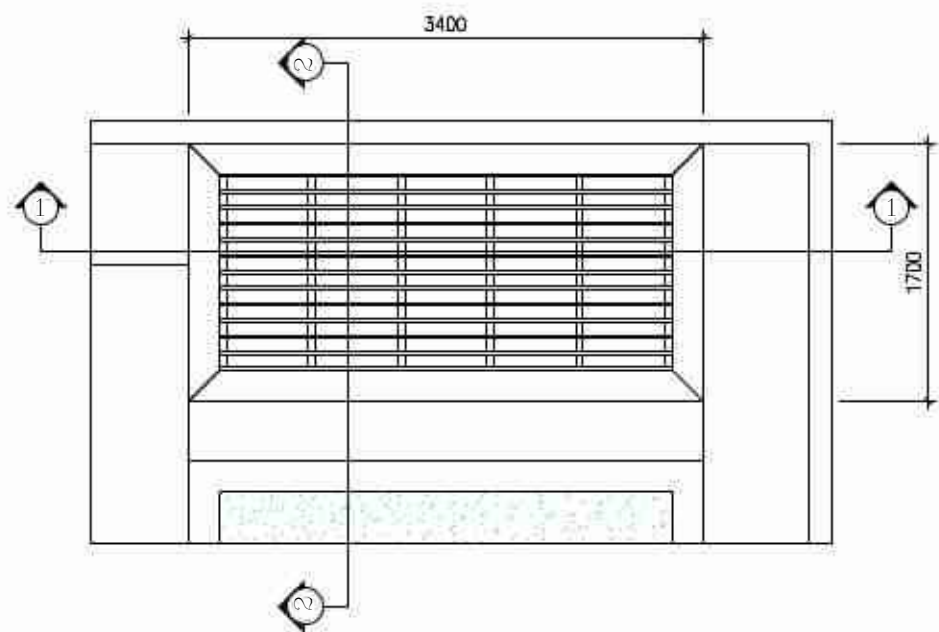
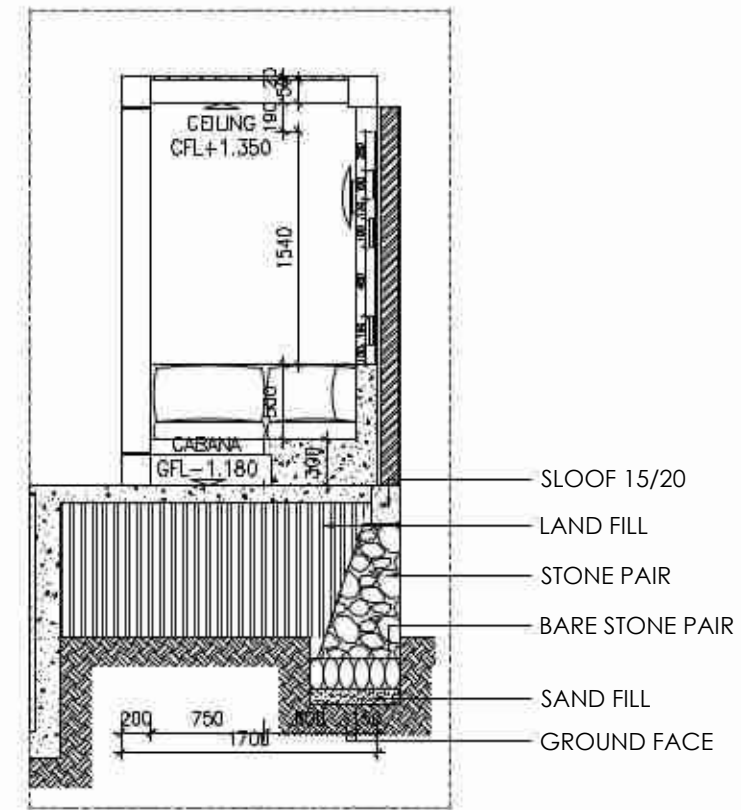
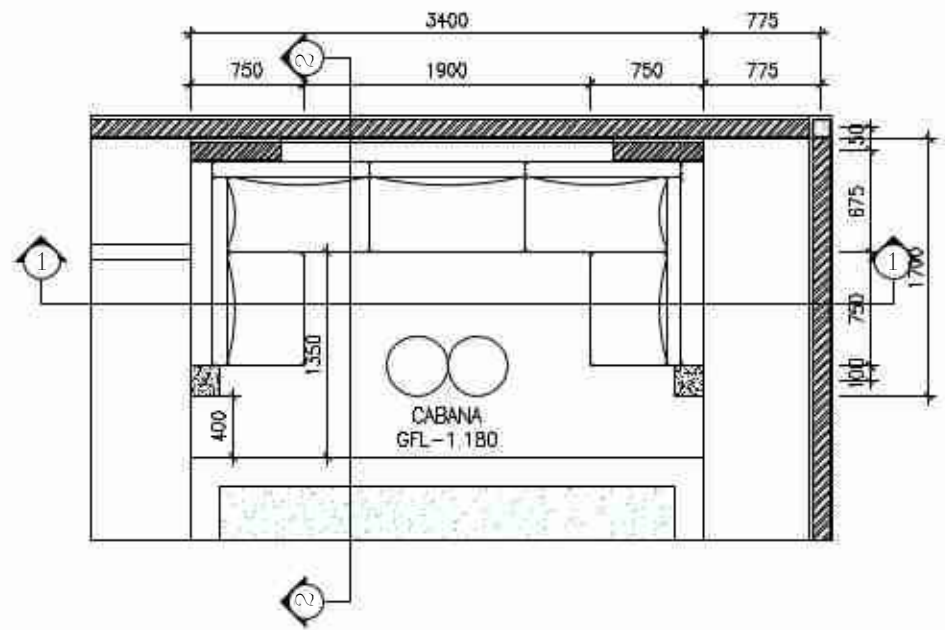

CABANA PLAN, SECTION AND DETAIL VILLA C
Scale 1 : 50

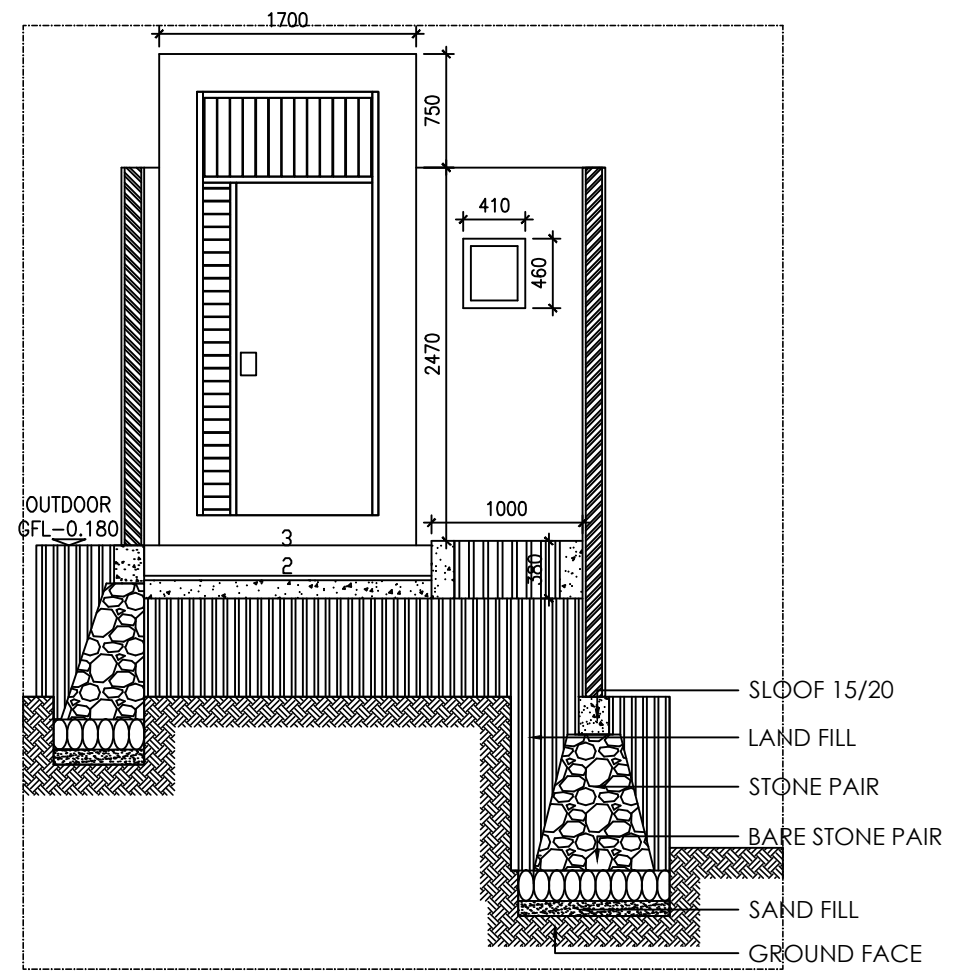
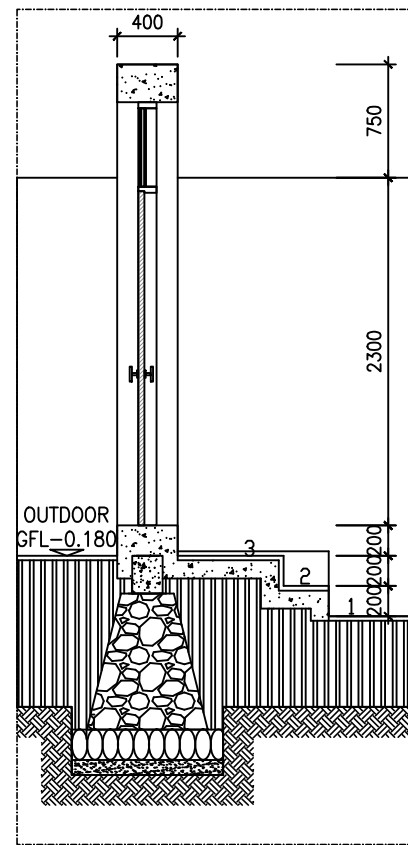
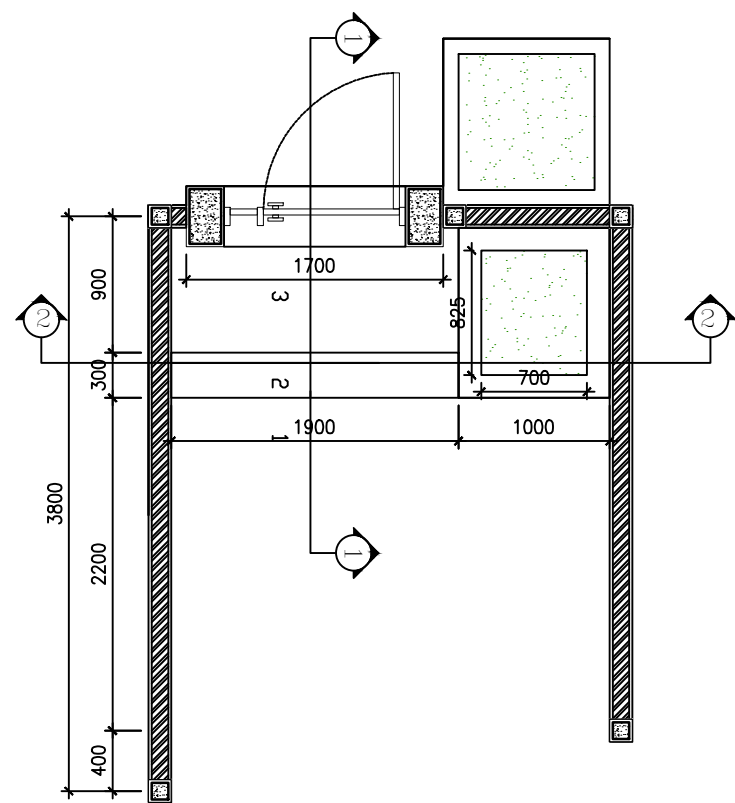

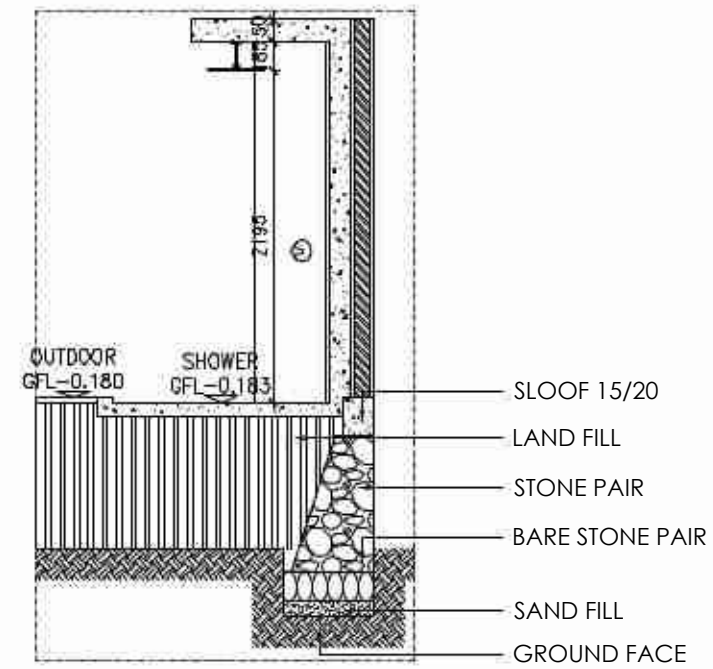
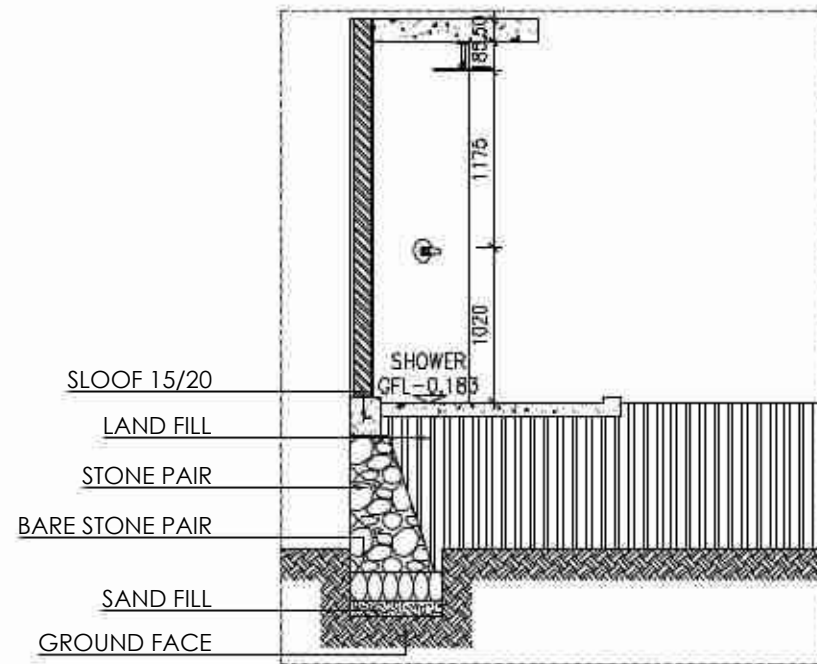
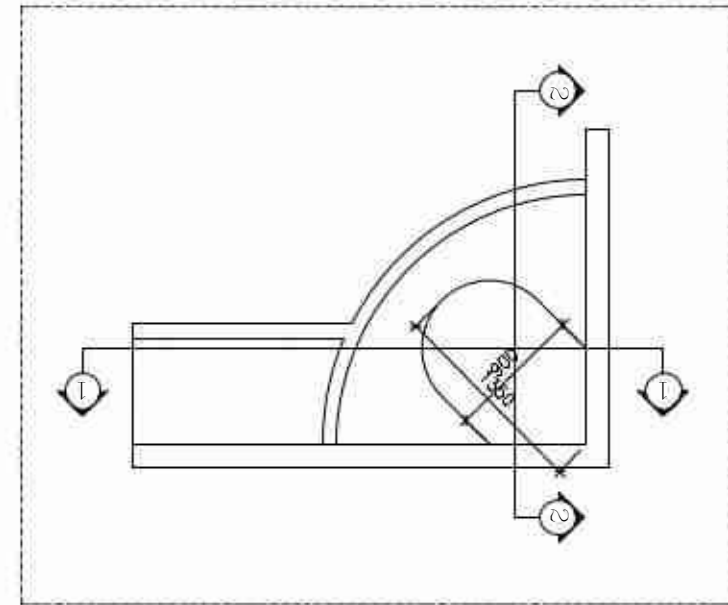
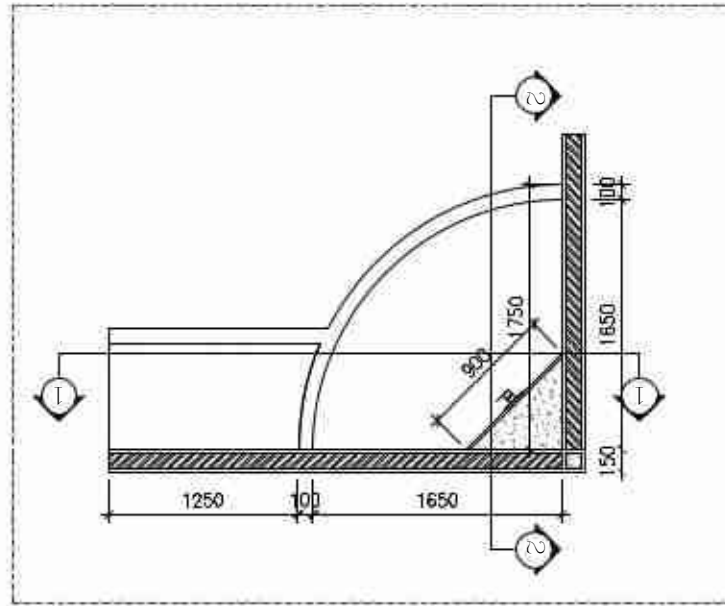

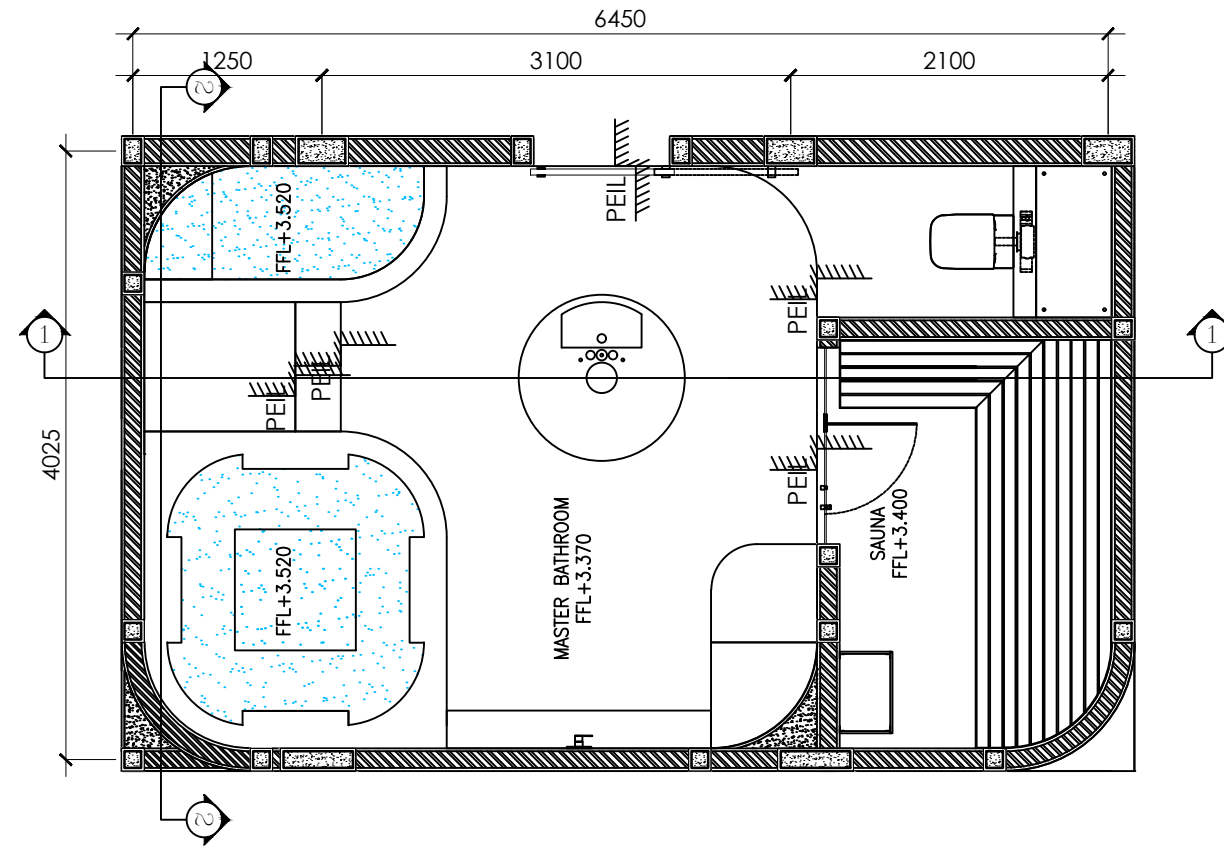
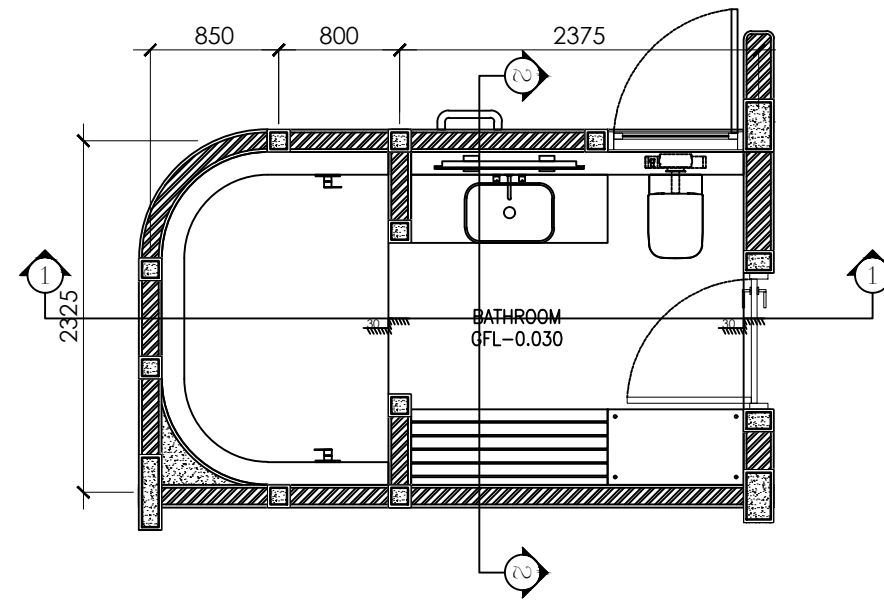

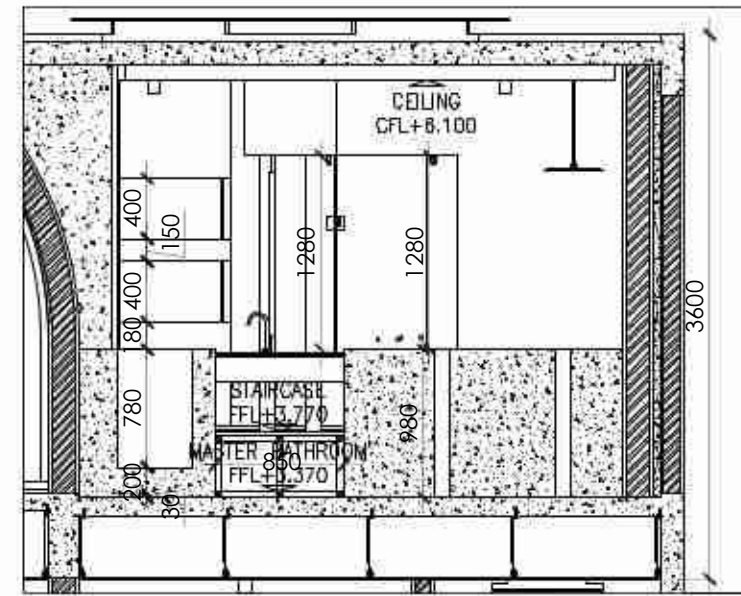
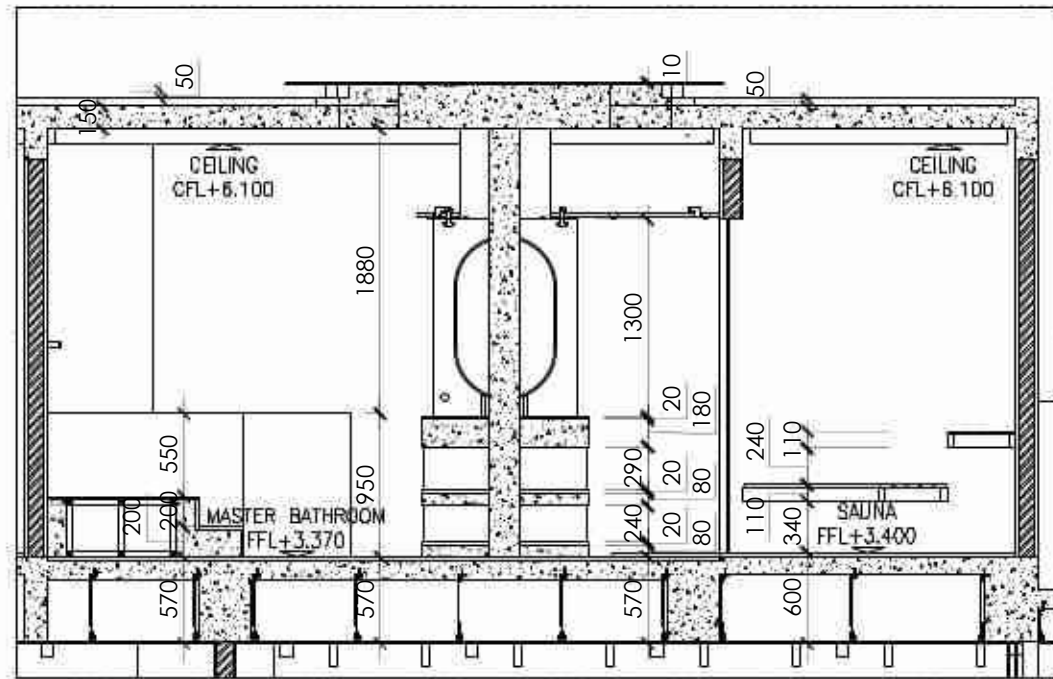
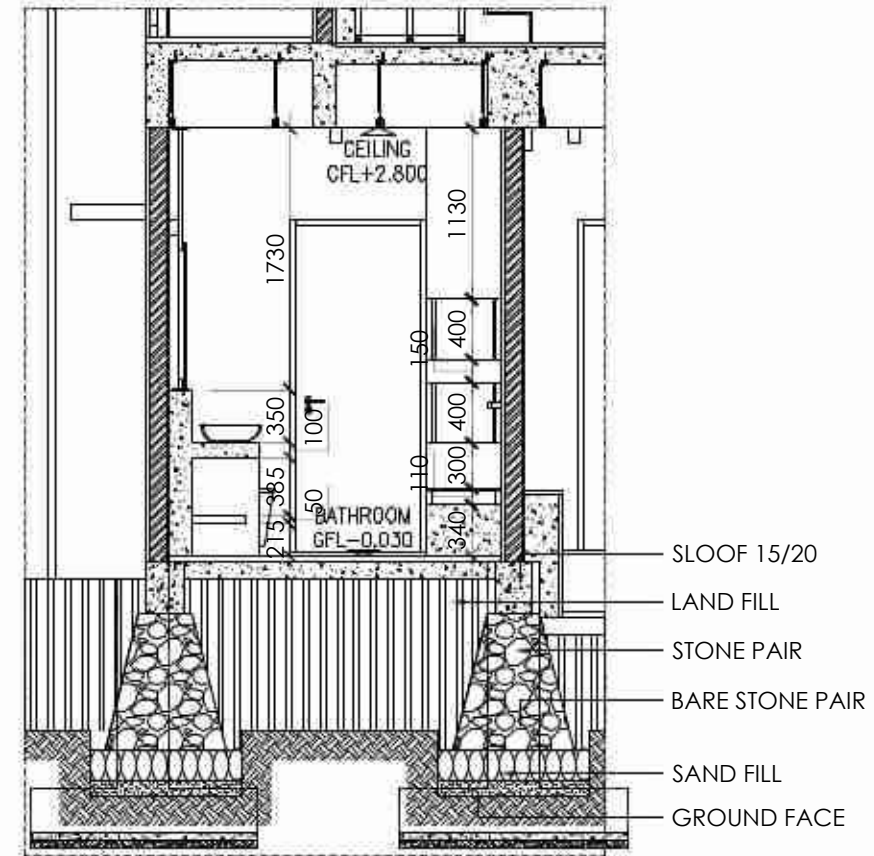
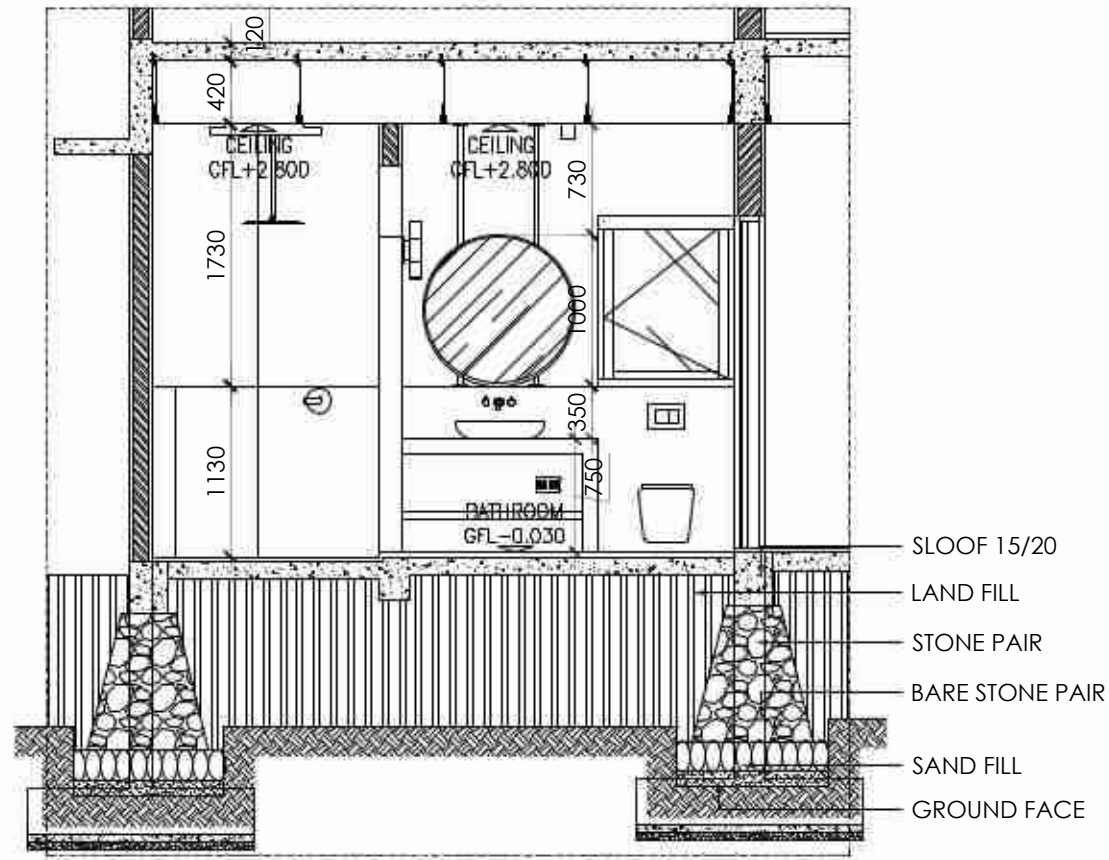

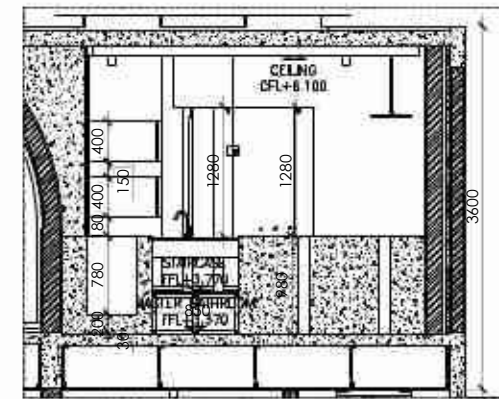
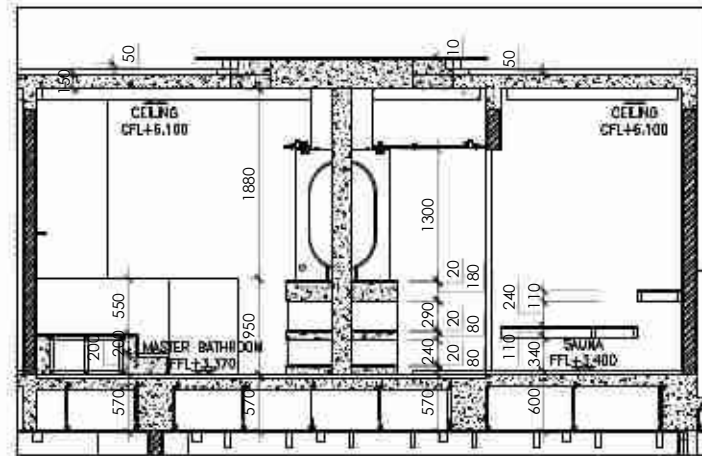
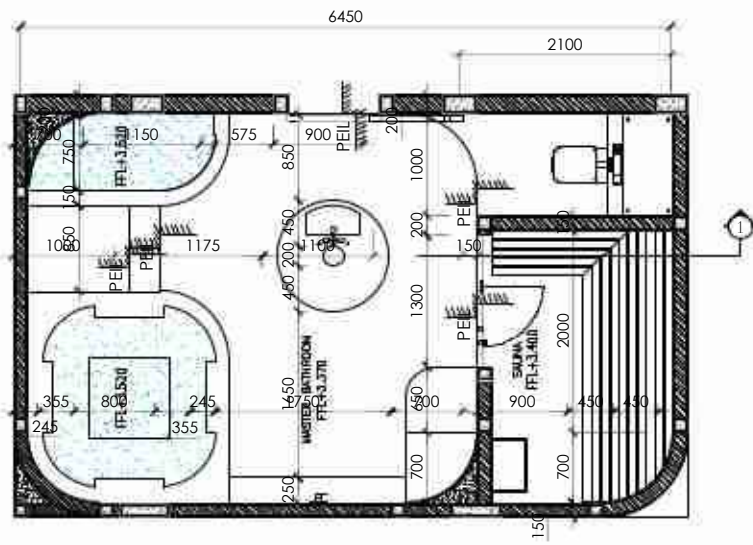
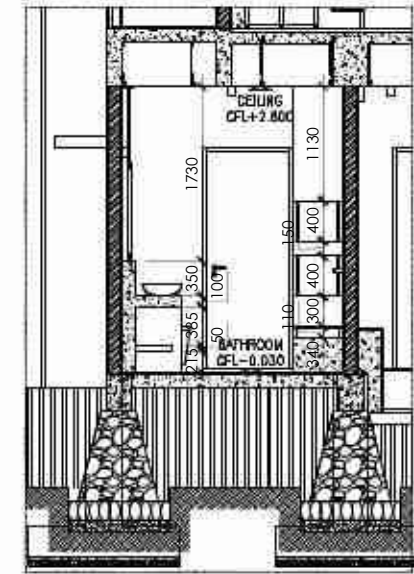
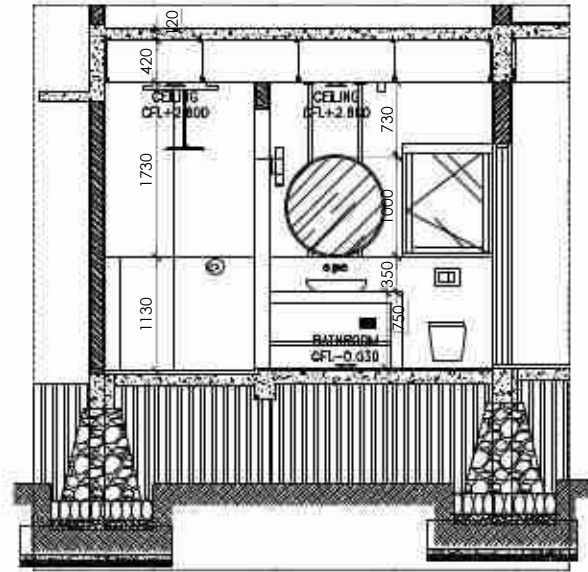
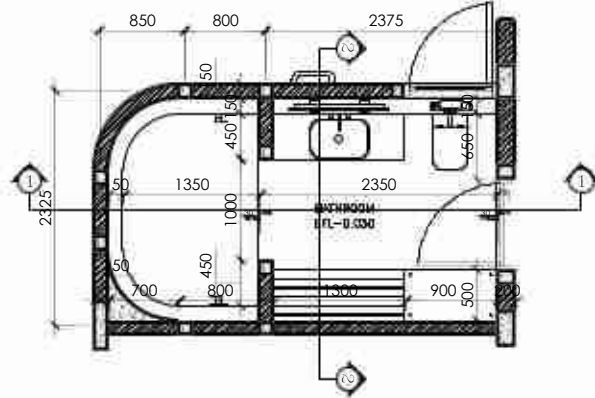

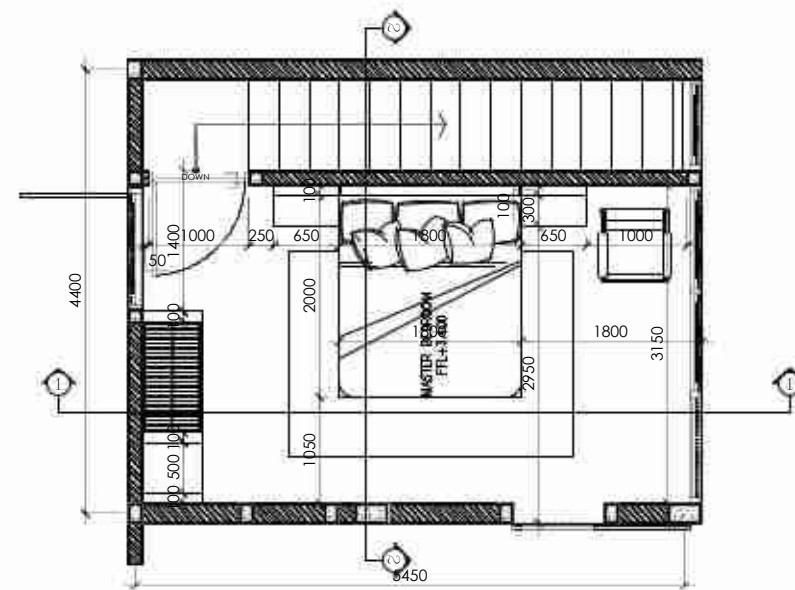
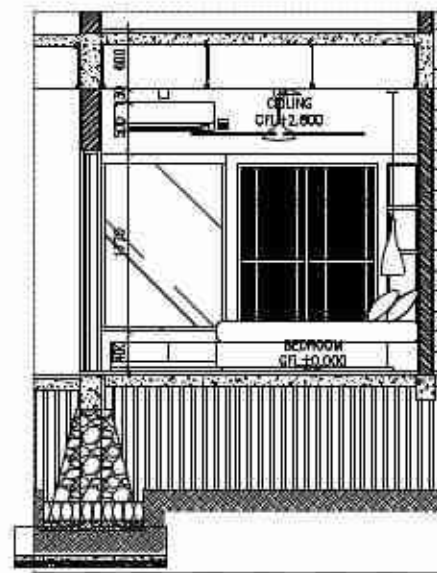
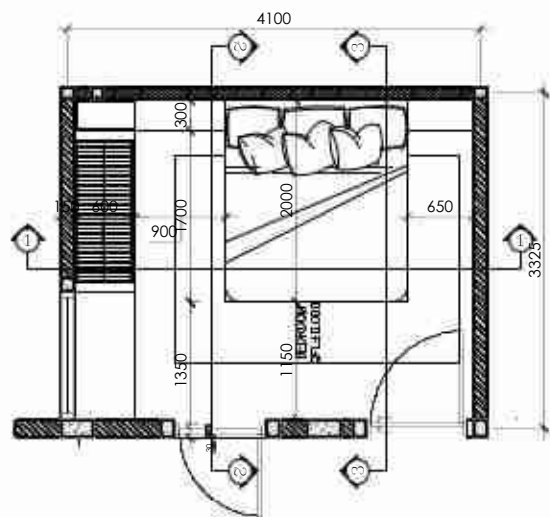
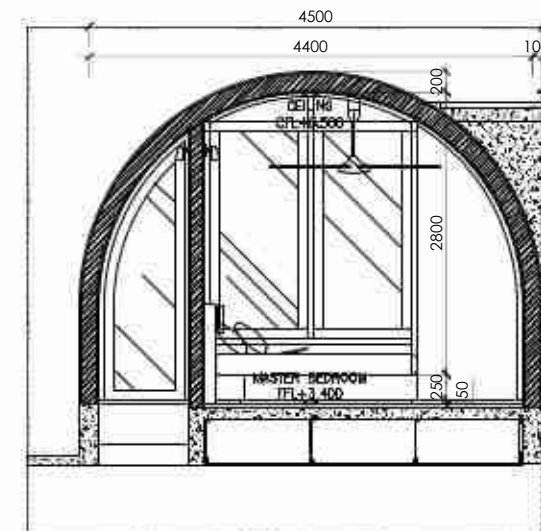
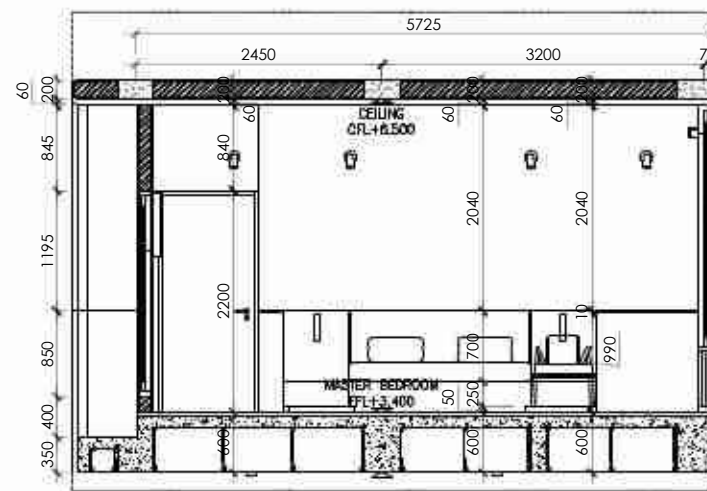
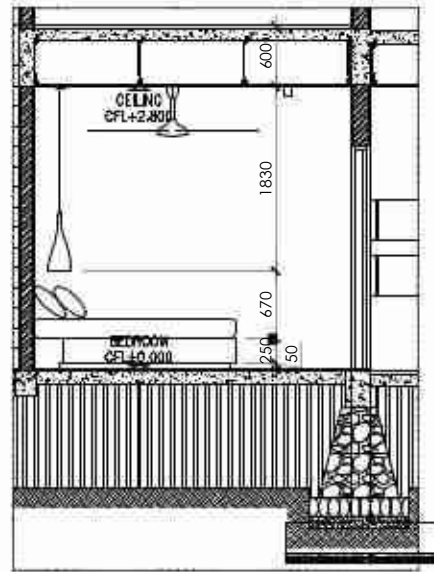
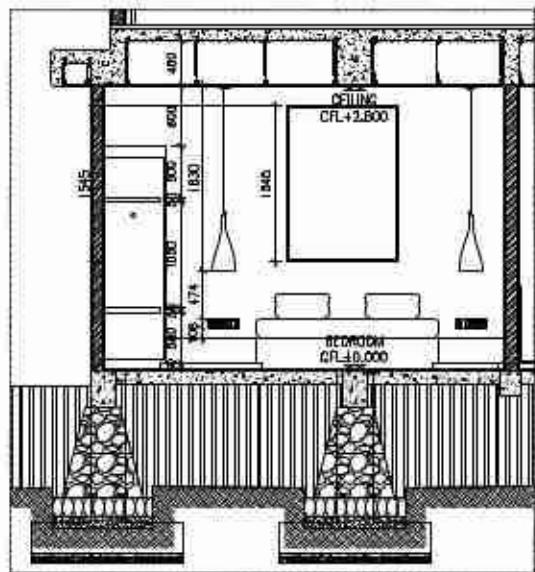

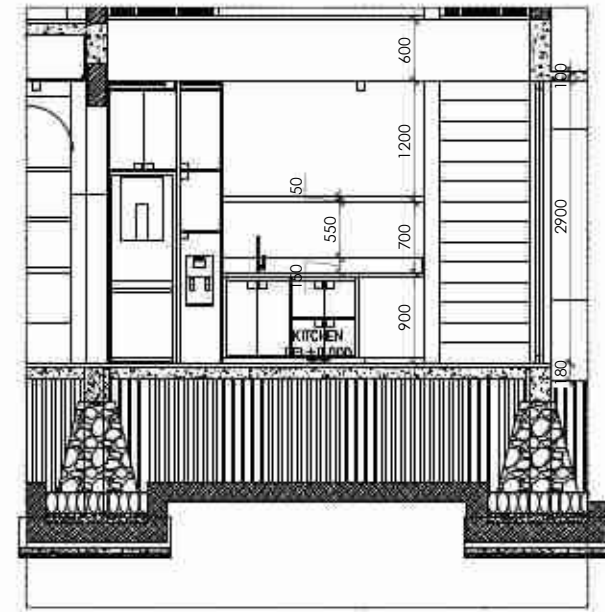
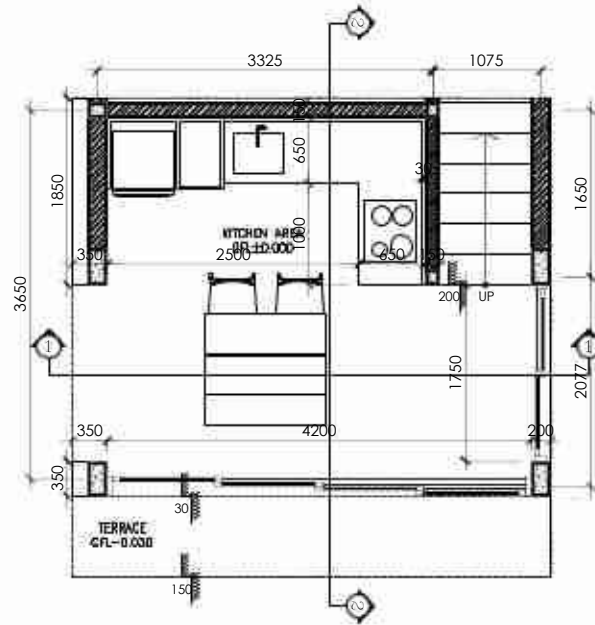
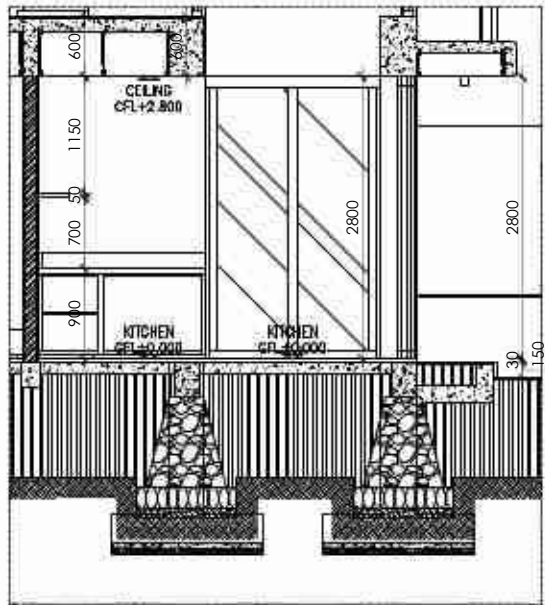

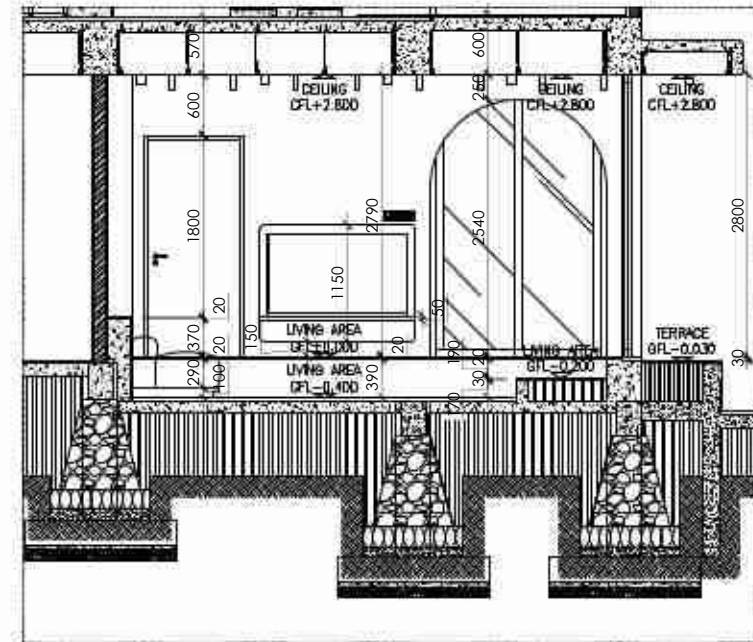
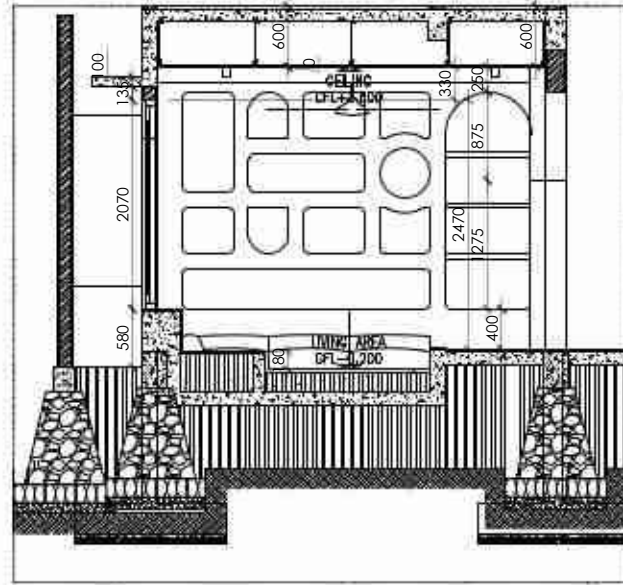
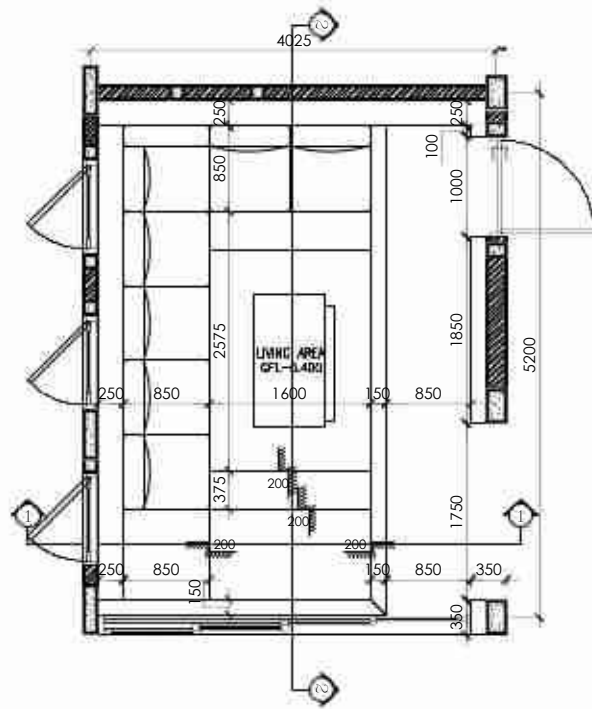

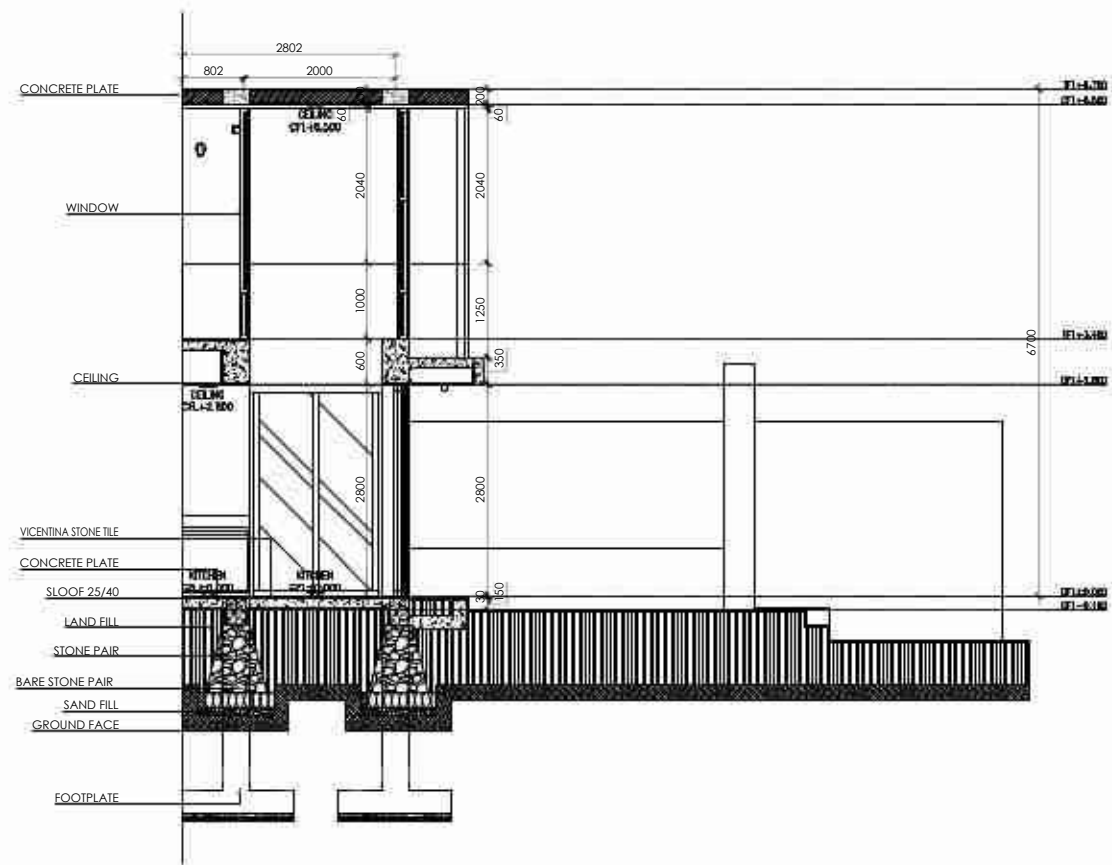
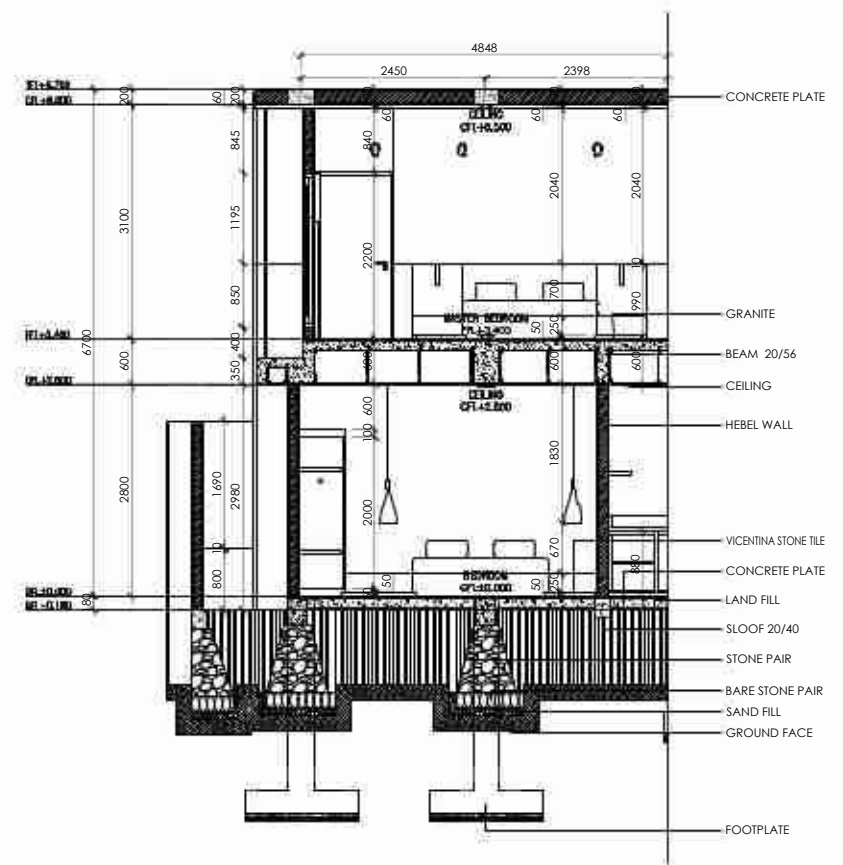
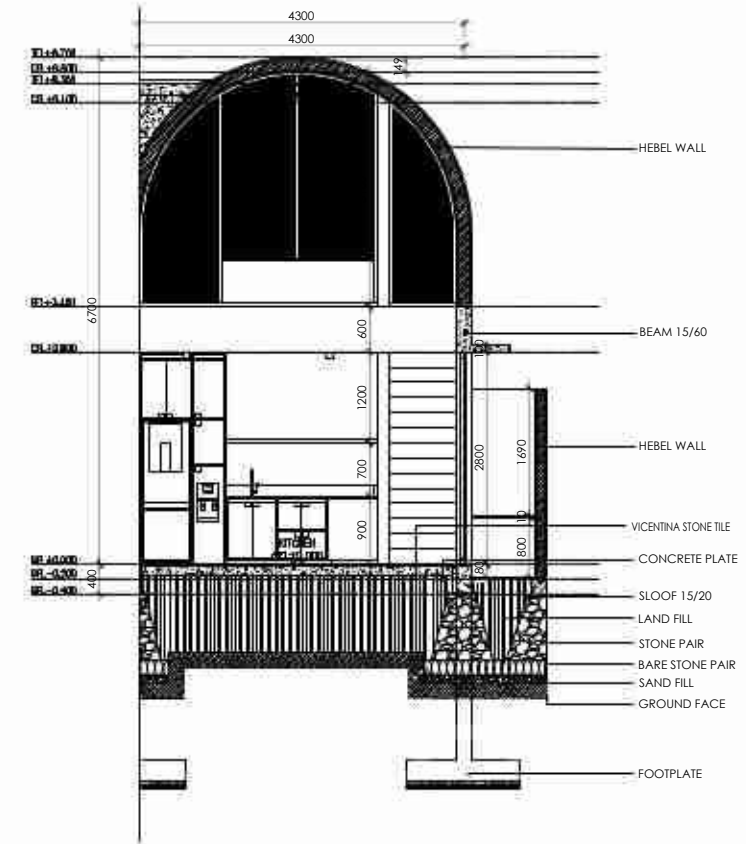
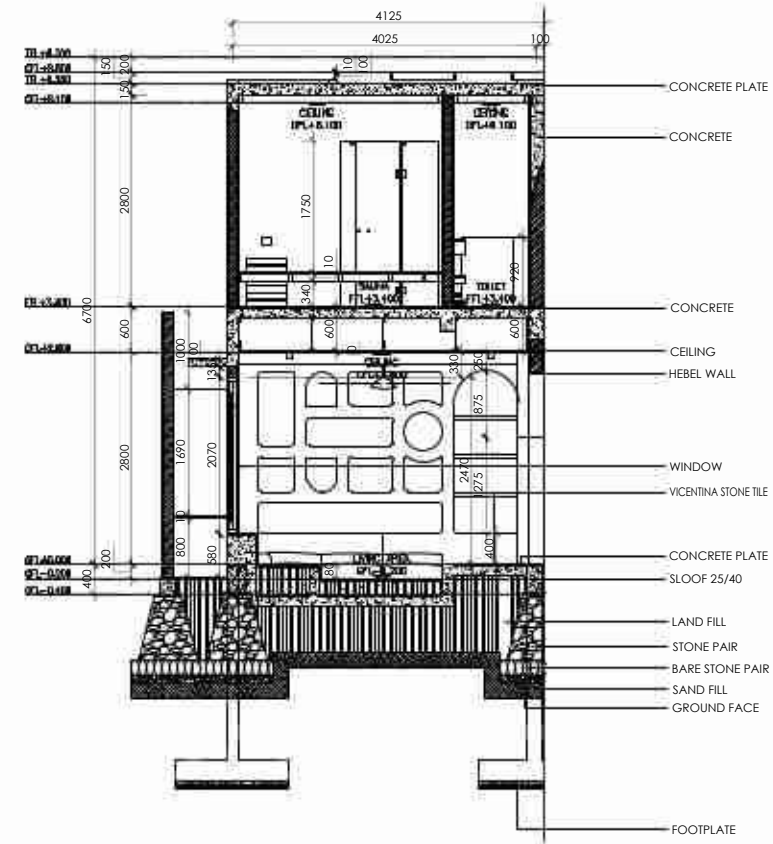

BLOW UP SECTION 1 VILLA C
Scale 1 : 100

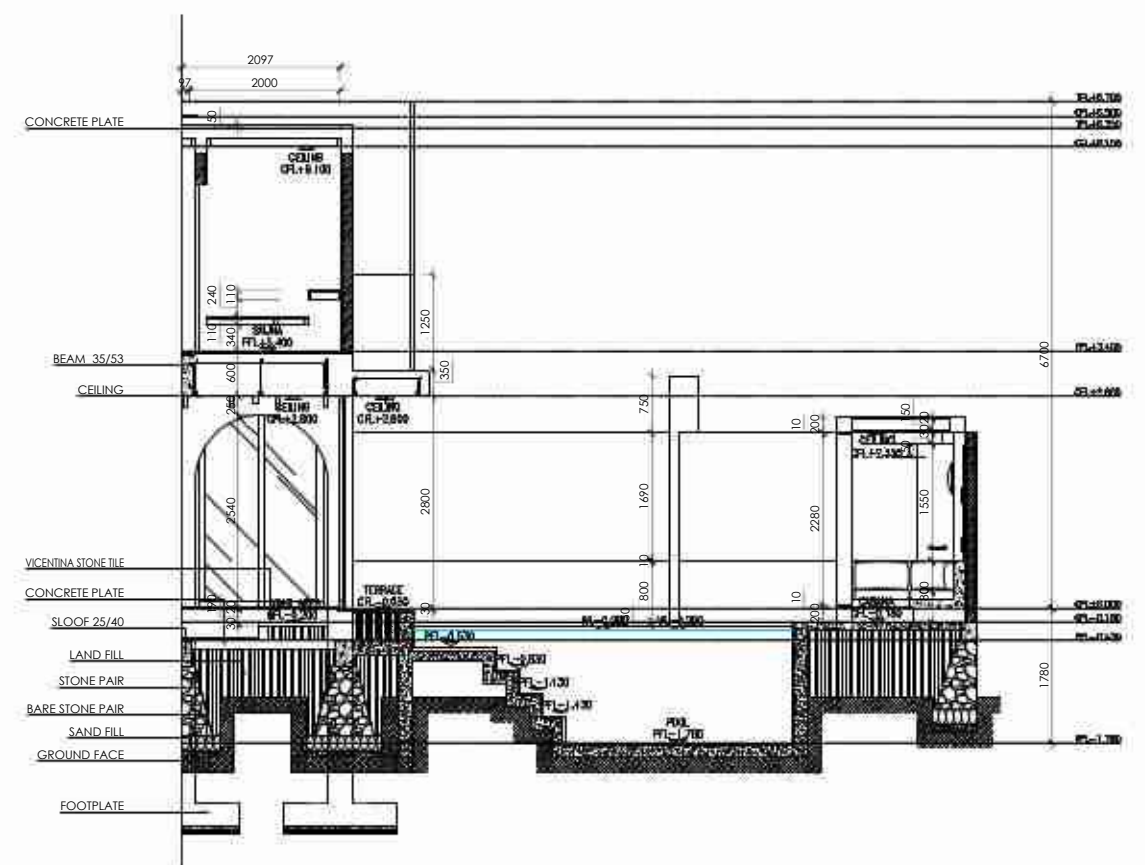
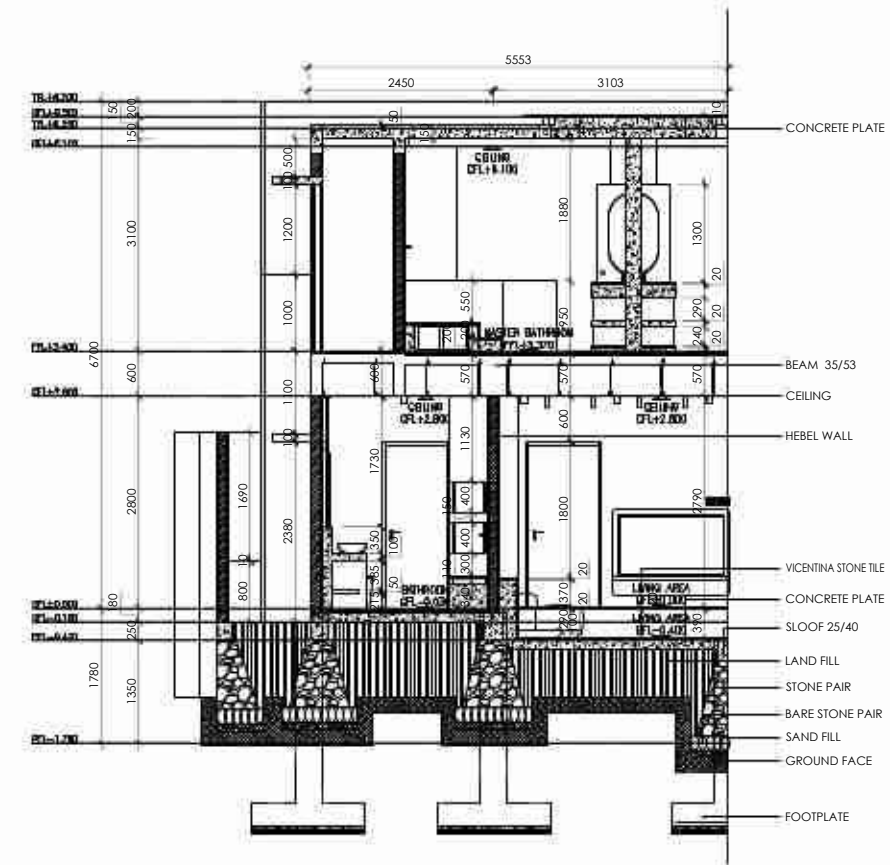
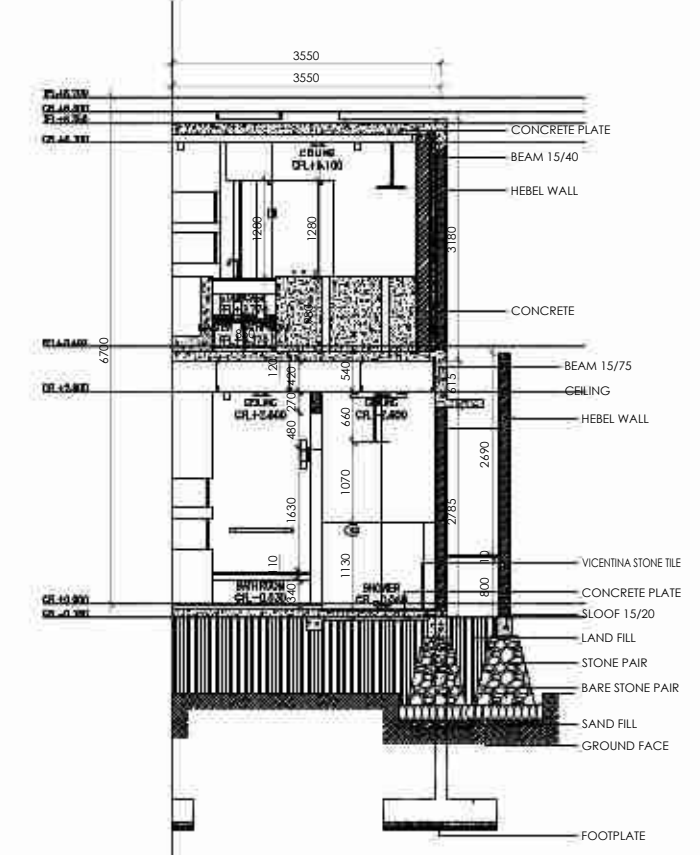
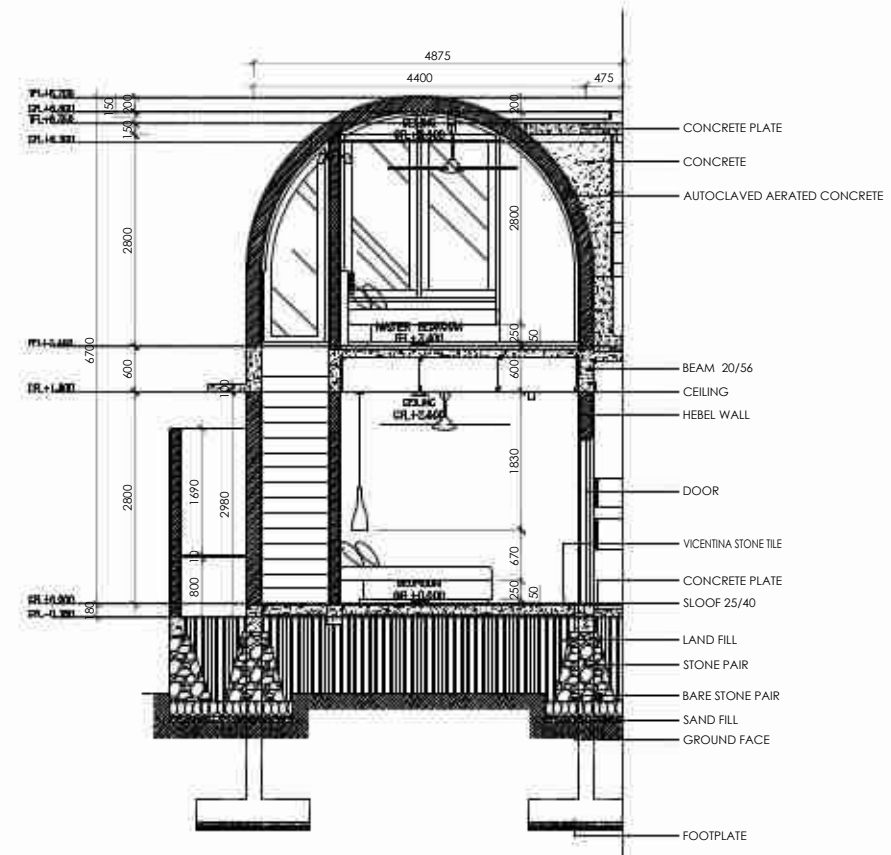

BLOW UP SECTION 2 VILLA C
Scale 1 : 100